

# RADIO NEWS

REG. U.S. PAT. OFF.

20 Cents  
October  
1921

Over 100 Illustrations  
Edited by H. GERNSBACK

A NEW LOUD TALKER  
SEE PAGE 286



"THE 100% WIRELESS MAGAZINE"



# CUNNINGHAM

## TUBES MEET EVERY AMATEUR REQUIREMENT



The trade-mark GE is the guarantee of these quality tubes. Each tube is built to most rigid specifications.

	C300 Gas Content Detector	C301 Plotron Type Amplifier	C302 5 Watt Power Tube	C303 50 Watt Power Tube	C304 250 Watt Power Tube
Filament Terminal Voltage.....	5 V.	5 V.	7.5 V.	10 V.	11 V.
Filament Supply Voltage.....	6 V.	6 V.	10 V.	12 V.	12 V.
Filament Current.....	1.0 amp.	1.0 amp.	2.35 amp.	6.5 amp.	14.75 amp.
Plate Voltage.....	18 to 25 V.	40 to 100 V.	350 V. normal	1000 V. normal	2900 V. normal
Plate Current.....	¼ to 1 milli. amps.	1 to 5 milli. amps.	.045 amp.	.15 amp.	.25 amp.
Output Impedance.....	10,000 ohms	21,000 ohms at 40 Volts 14,000 ohms at 100 Volts	4,000 ohms		6,000 ohms
Amplification Constant.....		6.5 to 8 at 40 V. 8 to 10 at 100 V.	7.5	10	25
Watts Output.....			5 normal	50 normal	250 normal
Dimensions (overall).....	1 ¼"x4 5/16"	1 ¾"x4 5/16"	2 ½"x5 ¼"	2"x7 ½"	5"x14 ½"
Base.....	4 Prong Standard	4 Prong Standard	4 Prong Standard	4 Prong Special	Special Mounting
PRICE.....	\$5.00	\$6.50	\$8.00	\$30.00	\$110.00



Cunningham  
C-300  
Detector  
Gas Content



Cunningham  
Amplifier  
Plotron Type  
C-301



Cunningham  
C-302  
5 Watt Power Tube

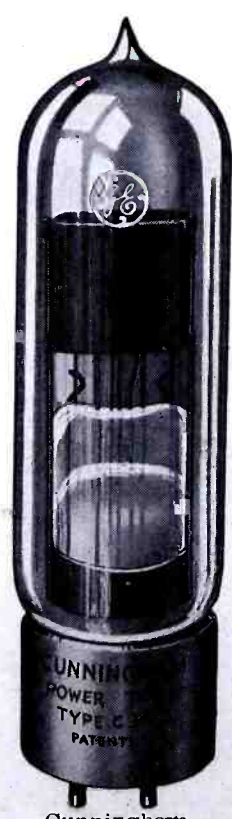

Cunningham  
C-303  
50 Watt Power Tube



Cunningham  
C-304  
250 Watt Power Tube

DEALERS: Standard Packages F. O. B. Cleveland, San Francisco, Chicago, New York. Broken Packages F. O. B. San Francisco and Chicago.

### E. T. CUNNINGHAM

Trading as Audiotron Mfg. Company  
Since 1915

35 Montgomery St., San Francisco

Herbert H. Frost, Central and Eastern Representative, 154 West Lake St., Chicago, Ill.



'A JOURNEY of a thousand miles,'  
said Lao Tzu, 'begins with a  
single step!'

"Let a Grebe Receiver be the first  
step of your radio-journey—  
lest you be compelled to return  
and start anew."

*Doctor Hu*



The CR-9 Receiver is the ideal equipment for C.W.  
and radiophone reception.

A Regenerative Receiver—150 to 3,000 Metres—  
moulded variometers, tapered-grip dials, rubber-tired  
verniers, direct-reading rheostat controls, automatic  
plug and jack filament control system.

So simple to operate—connect antennæ, ground, bat-  
teries—insert tubes—and *listen!*

Ask your Dealer to show you this instrument or write  
us for descriptive bulletin.

**A. H. GREBE & CO., Inc., Richmond Hill, N. Y.**

The Sine of



The Right Kind

all, cash or cash equivalents and all  
are prohibited.

**INTERNATIONALLY 20 POUND WEIGHT**

Specific prohibitions/restrictions may  
be found in the International Mail Manual (IMM) country pages for

Affix customs declaration PS Form 2976-A  
to the customs form pouch.

Country of Destination Pays de destination:

**PRIORITY<sup>®</sup>**  
**MAIL**  
EXPERIENCED POSTAL SERVICE

1000m Flat Rate Box  
Domestic and International Use



USPS packaging products have been awarded Cradle  
to Cradle Certification<sup>SM</sup> for their ecologically intelligent  
design. For more information go to [mbdc.com/usps](http://mbdc.com/usps)

Cradle to Cradle Certified<sup>SM</sup> is a certification mark of MBDC.



Please Recycle



CIRCULATION LARGER THAN ALL OTHER RADIO MAGAZINES COMBINED

# RADIO NEWS

REG. U.S. PAT. OFF.

20 Cents  
October  
1921

Over 100 Illustrations  
Edited by H. GERNSBACK

A NEW LOUD TALKER  
SEE PAGE 286



"THE 100% WIRELESS MAGAZINE"



# CUNNINGHAM

## TUBES MEET EVERY AMATEUR REQUIREMENT



The trade-mark GE is the guarantee of these quality tubes. Each tube is built to most rigid specifications.

	C300 Gas Content Detector	C301 Plotron Type Amplifier	C302 5 Watt Power Tube	C303 50 Watt Power Tube	C304 250 Watt Power Tube
Filament Terminal Voltage.....	5 V.	5 V.	7.5 V.	10 V.	11 V.
Filament Supply Voltage.....	6 V.	6 V.	10 V.	12 V.	12 V.
Filament Current.....	1.0 amp.	1.0 amp.	2.35 amp.	6.5 amp.	14.75 amp.
Plate Voltage.....	18 to 25 V.	40 to 100 V.	350 V. normal	1000 V. normal	2000 V. normal
Plate Current.....	¼ to 1 milli. amps.	1 to 5 milli. amps.	.045 amp.	.15 amp.	.25 amp.
Output Impedance.....	10,000 ohms	21,000 ohms at 40 Volts 14,000 ohms at 100 Volts	4,000 ohms		6,000 ohms
Amplification Constant.....		6.5 to 8 at 40 V. 8 to 10 at 100 V.	7.5	10	25
Watts Output.....			5 normal	50 normal	250 normal
Dimensions (overall).....	1 ¼" x 4 5/16"	1 ¼" x 4 5/16"	2 ½" x 5 ¼"	2" x 7 ½"	5" x 14 ½"
Base.....	4 Prong Standard	4 Prong Standard	4 Prong Standard	4 Prong Special	Special Mounting
PRICE.....	\$5.00	\$6.50	\$8.00	\$30.00	\$110.00



Cunningham  
C-300  
Detector  
Gas Content



Cunningham  
Amplifier  
Plotron Type  
C-301



Cunningham  
C-302  
5 Watt Power Tube

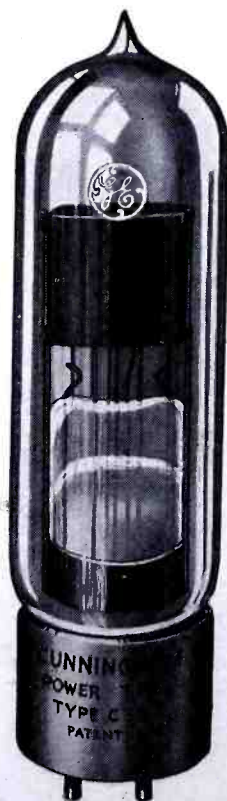

Cunningham  
C-303  
50 Watt Power Tube



Cunningham  
C-304  
250 Watt Power Tube

DEALERS: Standard Packages F. O. B. Cleveland, San Francisco, Chicago, New York. Broken Packages F. O. B. San Francisco and Chicago.

### E. T. CUNNINGHAM

Trading as Audiotron Mfg. Company  
Since 1915

35 Montgomery St., San Francisco

Herbert H. Frost, Central and Eastern Representative, 154 West Lake St., Chicago, Ill.



'A JOURNEY of a thousand miles,'  
said Lao Tzu, 'begins with a  
single step!'

"Let a Grebe Receiver be the first  
step of your radio-journey—  
lest you be compelled to return  
and start anew."

*Doctor Wu*



The CR-9 Receiver is the ideal equipment for C.W.  
and radiophone reception.

A Regenerative Receiver—150 to 3,000 Metres—  
moulded variometers, tapered-grip dials, rubber-tired  
verniers, direct-reading rheostat controls, automatic  
plug and jack filament control system.

So simple to operate—connect antennæ, ground, bat-  
teries—insert tubes—and *listen!*

Ask your Dealer to show you this instrument or write  
us for descriptive bulletin.

A. H. GREBE & CO., Inc., Richmond Hill, N. Y.

The Sine of



The Right Kind



# CHEMISTRY offers the opportunity



## Dr. T. O'Connor Sloane Will Teach You Chemistry Right In Your Own Home

Dr. Sloane will teach you Chemistry by a practical, intensely interesting method. Our home study course written by Dr. Sloane himself is practical, logical and remarkably simple. It is illustrated by so many experiments that are performed right from the start that no one, even with the most common education, will have any trouble in mastering this science. Dr. Sloane teaches you in your own home by the same successful system by which he has already taught thousands in the class room. This method is a short cut gained through years of experience which will save you weeks of time. And, Dr. Sloane personally examines and corrects all examination papers, pointing out your mistakes and correcting them for you. This personal training will be of inestimable value in your future career.

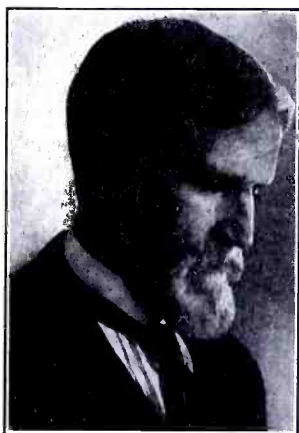

DR. T. O'CONNOR SLOANE, A.B., A.M., LL.D., Ph.D.

Noted Instructor, Lecturer and Author. Formerly Treasurer American Chemical Society and a practical chemist with many well known achievements to his credit. Not only has Dr. Sloane taught chemistry for years but he was for many years engaged in commercial chemistry work.

## Earn Big Money

Many industrial firms pay their chemists as high as \$15,000 a year. Salaries of \$10,000 to \$12,000 a year are very common. Why be satisfied with small pay and hard, thankless work—be your own boss and train yourself in a few short months to have a real profession. The work of the chemist is extremely interesting. If you are fond of experimenting, if you like exciting and intensely interesting work, take up Chemistry. To the man who is dissatisfied with his present job, to the young man just deciding on his life work, Chemistry holds alluring charms, and countless opportunities. If you want to earn more money, the way is open through our course in Chemistry.

### READ WHAT ONE OF OUR STUDENTS SAYS:

(This Letter was Positively Unsolicited)

Phoenix, Ariz., Sept. 8, 1921.

Chemical Institute of N. Y., New York City.

Gentlemen:—Just about this time with most courses is the time when you feel like "cussing." I had struggled with several books in chemistry up to the time I started this course and was just about disgusted with them all. But say! this is just like reading some fascinating fiction story. Perhaps this is somewhat strong language but it expresses exactly what I mean. All of the frocks and frills have been left out and the bare facts are printed so an ordinary human can understand them without losing all the religion and bringing up his possessions. As a rule I am not much on bragging about anything but this is too good to keep to myself. I was planning on taking a course in Chemistry at High School this year but "they will have to get up pretty early in the morning" to produce a course that will even start to compare with this. Sincerely yours,

(Signed) FOREST BAKER.

## Good Chemists Command High Salaries Now Is The Time To Study Chemistry

Never before has the world seen such wonderful opportunities for chemists as exist today. The war has awakened the United States to the need of trained chemists and chemical engineers. Everywhere the demand has sprung up. In factories, mills, laboratories, electrical shops, industrial plants of all kinds, the lack of trained chemists is acutely felt. In every branch of human endeavor the need for chemists has arisen. No profession offers such alluring opportunities—and the next ten years are going to show the greatest development in this science that this country has even seen. You be one of the fortunate to get in now.

### Pay As You Go Along

The price of our course is very low—only \$125. This includes everything, even the chemistry outfit—there are no extras to buy with our course. The same education that we give would cost you close to a thousand dollars at a University. You can pay in small monthly amounts as you go along. Our plan of monthly payments places a chemical education within the reach of every one. Write us and let us explain our plan in full—give us the opportunity of showing you how you can qualify for a highly trained technical position without even giving up your present job.

### Diploma Given to Every Graduate

Graduates of our school are qualified to take positions as chemists. With conscientious work ambitious graduates find promotion very rapid.

### SPECIAL 30 DAY OFFER

Besides giving absolutely free to every student a valuable chemistry outfit, we are making an additional special offer for a short while only. You owe it to yourself to find out about it. Write today for full information and free book "Opportunities for Chemists." Send the coupon right now while it is fresh in your mind. Or just write your name and address on a postal and mail it to us. But whatever you do, act today before this offer is withdrawn.

### BIG CHEMISTRY OUTFIT Given Absolutely FREE

To Every Student

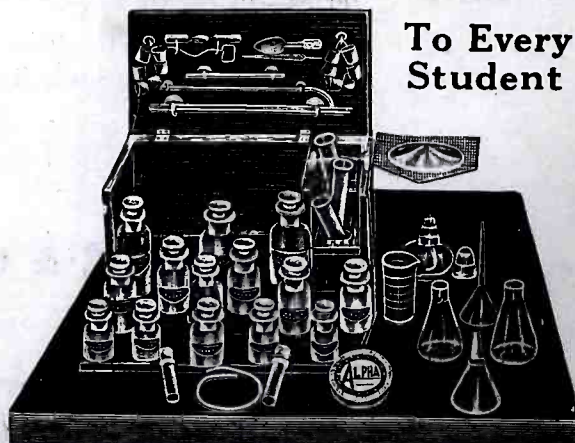

We give to every student absolutely free this valuable chemical outfit. It includes everything you need for the entire course. You couldn't buy so complete an outfit anywhere for one cent less than \$25.00. There are forty-two pieces of laboratory apparatus and supplies and eighteen different chemicals and reagents all enclosed in a fitted heavy wooden box with hinged front and cover. Full particulars about this free outfit are given in our free book "Opportunities for Chemists." Remember we do not charge you one cent for the outfit.

CHEMICAL INSTITUTE OF NEW YORK Home Extension Division 140—R Liberty St., New York City.

Please send me at once without any obligation on my part, your free Book "Opportunities for Chemists," and full particulars about the valuable chemistry outfit given free to every student. Also please tell me about your plan of payment and your special 30 day offer.

NAME .....

ADDRESS .....

CITY ..... R. N., Oct., '21.

CHEMICAL INSTITUTE of NEW YORK

140—R LIBERTY ST. Home Extension Division NEW YORK CITY



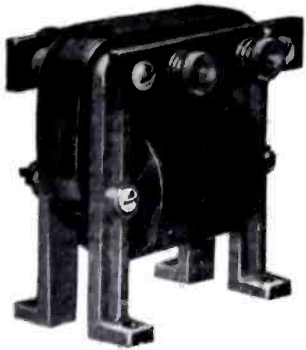

Atlas Amplifying Transformer Mounted

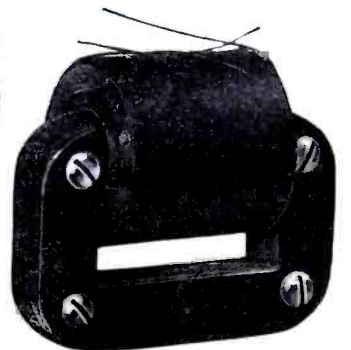

Atlas Amplifying Transformer Unmounted

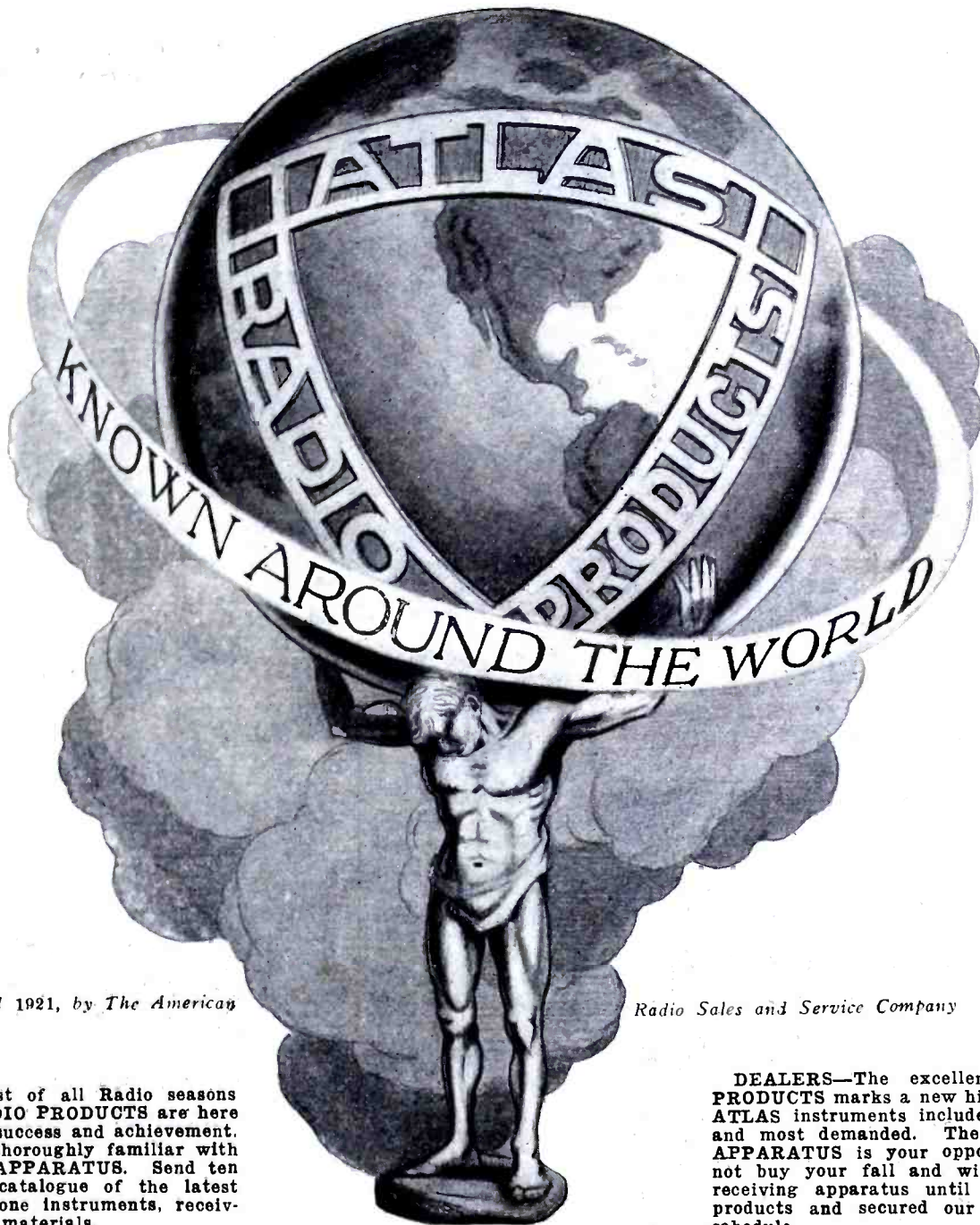

Copyrighted 1921, by The American

Radio Sales and Service Company

**AMATEURS**—The greatest of all Radio seasons is before you. ATLAS RADIO PRODUCTS are here to make it one of greatest success and achievement. Do not buy until you are thoroughly familiar with the excellence of ATLAS APPARATUS. Send ten cents in stamps for our catalogue of the latest C.W. telegraph and telephone instruments, receiving sets, parts and raw materials.

**DEALERS**—The excellence of ATLAS RADIO PRODUCTS marks a new high water mark in Radio. ATLAS instruments include only the most efficient and most demanded. The distributing of ATLAS APPARATUS is your opportunity paramount. Do not buy your fall and winter stock of C.W. and receiving apparatus until you have seen ATLAS products and secured our catalogue and discount schedule.

**PRODUCTION**—As the output of ATLAS instruments is limited to 15,000 for the next two months, you are advised to **ORDER AT ONCE**.

<b>ATLAS AMPLIFYING TRANSFORMERS</b>	
Mounted	\$5.00
Semi-mounted	4.00
Unmounted	3.50
Parts for Same	
Primary and secondary	2.50
Core	1.00
Four aluminum legs	.50
Panel & binding posts	1.00
<b>ATLAS CW TRANSFORMERS</b>	
Plate Transformers 500 Watt 1000-1500 Volts	
Mounted	\$24.00
Semi-mounted	22.00
Unmounted	19.00
Parts for Same	
Complete windings	15.00
Core	4.00
Supporting legs	3.00
Panel & binding posts	2.00
<b>ATLAS CW CHOKE COILS 1/2 HENRY 500 M.A.</b>	
Double semi-mounted	\$7.50
Single semi-mounted	5.50
Unmounted double	6.00
Unmounted single	4.00
Parts for Same	
Coils, each	2.00
Core	2.00
Supporting legs	1.50
<b>ATLAS VARIOMETERS</b>	
For Plate For Grid—Specify which	
Complete Variometer	\$6.00
Rotor, unwound	1.00
Stators, unwound	1.00
Rotor, wound	2.00
Stators, wound	2.00
Bearings, each	.50
Rods	.50
Binding Posts	.25
<b>ATLAS SUBMOUNTED PANEL SWITCH</b>	
Each	\$1.50
<b>ATLAS SUBMOUNTED VARIABLE</b>	
Grid leak on panel	\$1.50
<b>ATLAS DETECTORS</b>	
Panel	\$5.00
Panel engraved, etc.	10.00
Cabinet engraved, etc.	18.00
<b>ATLAS CABINETS</b>	
For 5 1/2" x 6 1/2" panel hinged top 6" deep	\$4.50
For 10" x 6 1/2" panel hinged top 6" deep	5.50
For 19" x 6 1/2" panel hinged top 6" deep	6.50

<b>ATLAS DX-52 SUPER OSCILLATION TRANSFORMER</b>	
	\$25.00
<b>ATLAS SYNCHRONOUS &amp; NON-SYNCHRONOUS MOTORS</b>	
	\$30.00 up
<b>ATLAS CW. POWER TRANSFORMERS</b>	
50 Watt, Secondary 375 Volts, Filament Windings 10 V. Variable	
Mounted	\$14.00
Semi-mounted	15.00
Unmounted	11.00
Parts for Same	
Complete windings	9.00
Core	2.00
Supporting Legs	2.00
Panel & binding posts	1.00
<b>ATLAS CW. POWER TRANSFORMERS</b>	
200 Watt, Secondary 350 and 550 Volts, Filament Winding 12 Volts Variable	
Mounted	\$19.00
Semi-mounted	17.00
Unmounted	15.00
Parts for Same	
Complete windings	12.00
Core	5.00
Supporting legs	2.00
Panel and binding posts	2.00
<b>ATLAS FILAMENT HEATING TRANSFORMERS</b>	
75 Watt, Filament Voltage 8-10	
Mounted	\$11.00
Semi-mounted	10.00
Unmounted	8.50
Parts for Same	
Complete windings	5.00
Core	5.50
Supporting legs	1.50
Panel and binding posts	1.00
<b>ATLAS CW TUNING INDUCTANCES</b>	
6 Inch Formica Tubes No. 8 Enameled Wire	
25 turn inductance	\$8.00
30 turn inductance	9.00
35 turn inductance	10.00
<b>ATLAS MODULATION TRANSFORMERS</b>	
Mounted	\$5.00
Semi-mounted	4.00
Unmounted	3.50
Parts for Same	
Primary and secondary	2.50
Core	1.00
Four supporting legs	.50
Panel and binding posts	1.00

<b>ATLAS FILAMENT HEATING TRANSFORMERS</b>	
150 Watt Filament Voltage 10-12	
Mounted	\$16.00
Semi-mounted	14.00
Unmounted	12.00
Parts for Same	
Complete windings	8.00
Core	4.00
Supporting legs	2.00
Panel and binding posts	2.00
<b>ATLAS CW CHOKE COILS 1/2 HENRY 150 M.A.</b>	
Double, semi-mounted	\$5.50
Single, semi-mounted	4.00
Double, unmounted	4.50
Single, unmounted	3.00
Parts for Same	
Coils, each	1.50
Core	1.50
Supporting legs	1.00
<b>ATLAS AMPLIFIERS</b>	
Panel 1 step	\$13.00
Panel 2 step	25.00
Cabinet 1 step	18.00
Cabinet 2 step	30.00
<b>ATLAS COMBINED DETECTOR AND AMPLIFIERS</b>	
Detector and 1 step panel	\$23.00
Detector and 2 step panel	35.00
Detector and 1 step cabinet	28.00
Detector and 2 step cabinet	40.00
<b>ATLAS CW CIRCUIT DRIVER</b>	
For measuring inductance, capacitance and wave length	
	\$40.00
<b>ATLAS RECEIVING &amp; POWER TUBE RHEOSTATS</b>	
6 Ohm 1.5 ampere for resolving tubes	\$1.00
6 Ohm 7 ampere for 5 to 50 watt power tubes	2.00
4 Ohm 16 ampere for 50 to 250 watt power tubes	5.00
<b>ATLAS SPECIAL RHEOSTATS FOR CONSTANT VOLTAGE CONTROL OF POWER TUBES</b>	
50 Ohm 5 ampere at 110 volts for primary control of 5 watt power tubes	\$5.00
50 Ohm 7 ampere at 110 volts for primary control of 50 watt power tubes	10.00
50 Ohm 15 ampere at 110 volts for primary control of 250 watt power tubes	15.00
Prices quoted on other sizes on request.	

**The AMERICAN RADIO SALES and SERVICE CO., Mansfield, Ohio, U.S.A.**



### THE RASCO "BABY"

The smallest and most efficient detector in the world—as well as the cheapest. Our illustration is an actual photograph, and while the various details can be seen at a glance, we feel so enthusiastic about it that we must tell you all of its good points. First, there is a solid hard rubber composition base, size 1½" x 1¼". We have not forgotten two holes to screw down the detector.

Then we have the nickel holder and binding post combined which holds the sliding, knurled, hard rubber composition knob. As you see, this knob not only revolves in its holder, but can also be moved back and forward in order to explore each point of the detector crystal.

Next we see the patent nickel detector cup and binding post combined. This is a little marvel all by itself and will not fail to avoke your admiration. No clamps, no soft metal to fuss with. You simply unscrew the knurled cap and insert your crystal into the stand, screw home the cap which leaves a goodly portion of the crystal exposed. The contact is perfect, while the crystal can be exchanged quickly in less than three seconds. By slightly unscrewing the cap, the crystal can be changed in position, in order to explore other sensitive spots. The catwhisker is of phosphor bronze and is attached to the horizontal bar by means of a filister head screw. Can be readily exchanged in less than two seconds. Wires can be connected to the binding post in a jiffy. All metal parts are nickel plated, and you will be proud of this little masterpiece.

No. 1898 Rasco Baby Detector complete with galena crystal, prepaid..... **50c**  
 No. 1899. The same but furnished with an additional piece of tested radocite crystal, prepaid..... **75c**

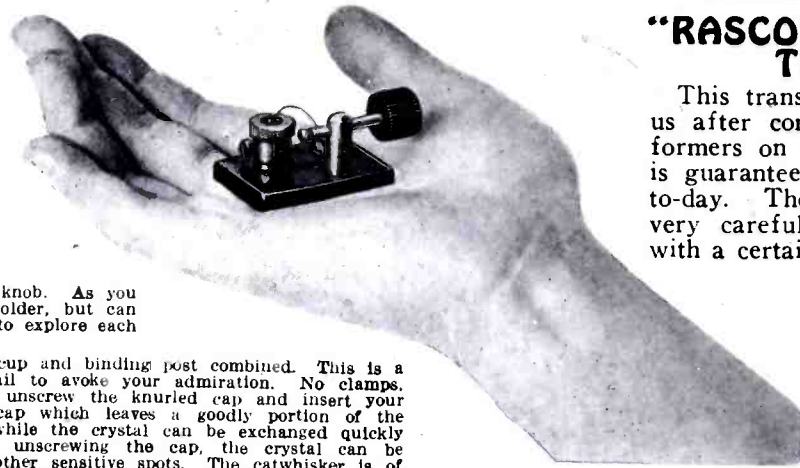

### "RASCO" AUDIO FREQUENCY TRANSFORMER

This transformer has been developed by us after comparing all the various transformers on the market. This transformer is guaranteed to equal any on the market to-day. The primary and secondary are very carefully built and are impregnated with a certain wax in vacuum. The stampings are of the best silicon steel. Only the very best material is used throughout.

Realizing the fact that most amateurs desire to "make their own" we furnish this transformer unassembled. Directions which accompany the transformer

are such that anyone can put the parts together in about ten to twelve minutes. This saves you considerable money, for the reason that manufacturers who assemble the transformers must charge you for the assembling work.

Illustration as shown is in full size. The weight complete is ten and one-half ounces. Note also that we ship all goods prepaid. We pay the freight.

No. 1100 "Rasco" Audio Frequency Transformer NOT ASSEMBLED, prepaid



VACUUM TUBE		
SERIES	TRANSMIT	RECEIVE
3 <sup>RD</sup> STEP	2 <sup>ND</sup> STEP	1 <sup>ST</sup> STEP
TICKLER	GRID ARIOMETER	PLATE VARIOMETER
SECONDARY CONDENSER	B BATTERY	A BATTERY
OUTPUT	INPUT	PRIMARY CONDENSER
ELEPHONE	PARALLEL	DETECTOR TUBE
+	COUPLING	

### "RASCO" NAME PLATES

Our name plates are of brass with a black background. The name is nickel-plated, standing out well upon the black background. Illustrations are in full size. Each plate has two screw holes. Order by name.

The two top plates, "Increase current," list at 10c each, illustrations full size. All others are 5c each. We also have these, not illustrated: Phones, Loading Coil Aerial, Ground, Secondary, Primary, Audion, Detector, Off, On, each 5c. In dozen lots, 50c prepaid.

NEW. The white plate in the lower right-hand corner is blank, and made of such material that you can write your own lettering on it with pencil, ink, or China ink. Price each 5c.



**WE GUARANTEE EVERY ORDER SHIPPED WITHIN 24 HOURS**

**DEALERS GET OUR SPECIAL PROPOSITION**

## THE "RASCO" CATALOG A COLOSSAL EVENT

There are many radio catalogs, but the "Rasco" catalog marks a radical change for the simple reason that it **CONTAINS 50 VACUUM TUBE HOOK-UPS**

This is the one and only radio catalog containing such wonderful free information. Complete hook-ups of all important vacuum tube circuits are given in clear diagrams with complete explanation. Just to name a few.—The V.T. as a detector; detector and one-step amplifier; regenerative circuit; De Forest ultraudion; V.T. to receive undamped and spark signals; Armstrong circuits; one step radio frequency amplifier and detector; three stage audio-frequency amplifier; short wave regenerative circuits; V.T. radio telephone; 4-stage radio frequency amplifiers; radio and audio frequency amplifier, inductively coupled amplifier; Armstrong superautodyne; radio frequency amplifier and crystal detector; C.W. transmitters; self-rectifying 2 tube C.W. transmitter; V.T. transmitter with 6 volt battery; radiophone using plate and grid modulation; one tube radio transmitter and receiver; experimental radiophone; radiophone using Colpitt oscillator circuit.

This list is only a partial one. You must positively see this wonderful book to appreciate it. It is made to fit the pocket—has heavy covers to withstand the wear and tear which it is sure to have at your hands because it will be your constant companion.

And Oh yes! Before we forget it. If you are in need of the following remember "Rasco has it." These are only a few things contained in this catalog. Lugs, Nuts, Dials, Knobs, Bakelite Sheets, Washers, Crystals, Litz Wire, Selenium, Cord Tips, Cap Nuts, Tin Foils, Name Plates, Spring Posts, Switch Parts, Metal Ribbon, Carbon Balls, Binding Posts, Switch Points, Switch Levers, Carbon Grains, Metal Pointers, Contact Points, Low Melting Metal, Carbon Diaphragms, Screws, Copper Strip, "Spaghetti" Name Plates, Sliders, Mica Switches, Resistance Wire, Variocoupler Rotors, Test Clips, Condenser Plates, Condensers, Antenna Connectors, Threaded Brass Rod, Ground Clamps, Etc., Etc.

The catalog contains 200 illustrations. On account of its great cost, this catalog cannot be distributed free of charge. It will only be mailed upon receipt of **15c in stamps or coin.**



**96-98 PARK PLACE, NEW YORK CITY**

Remember that this business was originated with the sole purpose to cater to the amateur who has small orders. **ALL OF OUR ORDERS ARE SMALL** and that is why your small order will never be side-tracked by us. A trial order will make you a life customer. You can order from the above illustrations. "We can only stick you once." Try us with a 50c order.

Factories: Brooklyn, N. Y.—Elkridge, Md.







# RADIO NEWS

H. GERNSBACK—Editor  
ROBERT E. LACAULT—Associate Editor

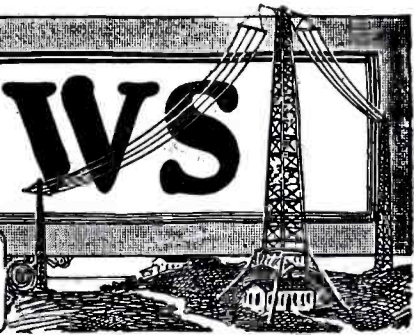

Vol. 3

OCTOBER, 1921

No. 4

## STUNTS

**W**E have often mentioned in these columns that there are few individuals who have such a great and wonderful field to work in as the radio research experimenter.

He, perhaps, has more materials to work with, and can choose more various apparatus than in all the other arts combined. There is hardly a material, hardly a piece of apparatus that at one time or another cannot be used in some way in radio work. The most impossible materials that one could think of, are pressed into radio service day after day.

An interesting point in case is the new amplifying loud talker illustrated on the front cover of this magazine. Who would think that an ordinary lithographic stone with a few pieces of other materials would reproduce the human voice loud and clear, much louder and better than the ordinary telephone? Nevertheless, such is the case.

The radio experimenter, as aforementioned, has a tremendous field open to him. There are more so-called fool stunts, and fool experiments that he can make than any one of us could dream of. Just the same, these fool stunts often bring forth something useful, although we do not wish to convey the impression that all such stunts are good. Probably there is not one good one in a thousand or more experiments, but if the researcher starts out with a common knowledge of physics, and has also a good knowledge of electricity in its various phases, he ought to be successful at one time or another.

Some years ago the writer, in one of his other magazines, published an article on talking dynamos, and talking electro magnets. Has anyone ever tried this in connection with radio? The writer very much doubts it, although here is a gold mine for the diligent researcher.

Not so many years ago, an engineer succeeded in making the ordinary incandescent lamp bulb talk loudly and distinctly. Why has no one ever used this idea for radio purposes? And if an ordinary incandescent bulb can be made to talk, why cannot an audion be made to talk in turn? One of these days, a radio bug will give us a good hook-up, which will do away with the phones entirely. He will place his vacuum tube on a resonant base, and with some fool circuit or another, he will make these

lamps talk so loudly that everything can be heard clearly throughout the room.

This stunt, by the way, as far as the detector end is concerned, is not so new. Way back in MODERN ELECTRICS, the writer described a stunt whereby a progressive radio bug placed a safety razor edge against a piece of silicon. The combination talked remarkably well, as far as is known. This has never been made use of commercially, nor has the idea been developed as well as it deserves. There is no reason why all radio crystals should not work in a similar manner. Perhaps by using certain metallic points in connection with a telephone diaphragm, we could get a direct amplification without the use of a telephone receiver. This stunt is worth trying.

Do you know that you can make a telephone merely by driving a two-penny nail in a piece of resonant wood, then wind No. 18 or No. 20 gauge magnet wire around the nail in such a way that the convolutions are loose? *They must not be tight.* When the thus constructed solenoid is in circuit with a microphone, the board will talk distinctly if placed against the ear. Now, here is an idea for radio bugs to exploit. It looks as if the stunt could be made useful for radio purposes.

In the July, 1908, issue of MODERN ELECTRICS, the writer described loud talkers made by means of ordinary paper condensers. If enough condensers are placed in series-parallel, such condensers, *provided they are not compressed*, will talk very loudly. To date, no radio experimenter, as far as we are aware, has succeeded in making a condenser talk in a radio way, but there is no good reason why he should not, and the experiment is eminently practicable.

A talking condenser only works well with a potential of twenty or thirty volts, but have we not got our "B" batteries which run up quite high in voltages, and which are just the thing for this experiment? Naturally, it depends entirely upon the hook-up.

The editor will be glad to hear of any experiments made along this line, and the writer certainly hopes that he has "started something" by giving these few suggestions.

H. GERNSBACK.

### IMPORTANT TO NEWSSTAND READERS:

In order to eliminate all waste and unsold copies, it becomes necessary to supply newsdealers only with a sufficient amount of copies for which they have actual orders. Please note that your newsdealer will be glad to reserve a copy for you every month. This costs you nothing and you will

be assured of your copies. Hand your newsdealer a slip of paper on which write your name and address with a request to reserve a monthly copy of RADIO NEWS for you. This will be the only way to assure you of your copy hereafter.



# Is the Storage Battery to Be Replaced as a Source of Auxiliary Power for Marine Radio?

By ARTHUR H. LYNCH

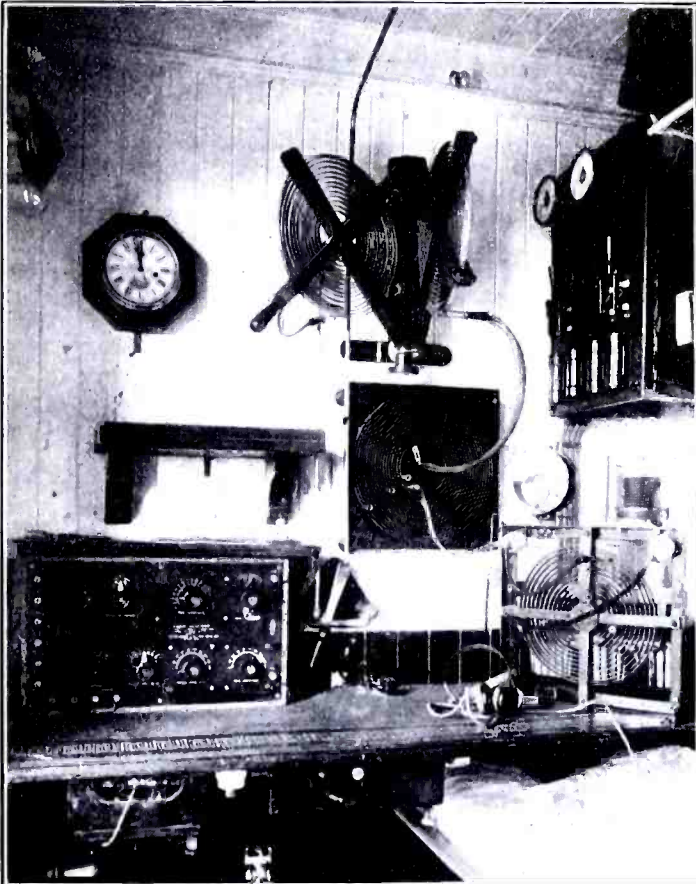

The 1 K.W. Telefunken Set Installed Aboard the "Relief," the Current for Which is Supplied by a Compact Motor Generator Unit Shown in Fig. 2.

**M**ANY vessels of today carry emergency lighting equipment, either for the reason that it is required by law, or because its value has long been established from an economic point of view. Nearly every vessel which boasts a radio set has some form of auxiliary power supply which is independent of the main engine. In a great many instances this power supply is not a matter of choice, but one of legislation.

The commercial operator will recall that they are of various forms and many will recall having had more than one rumpus with the chief engineer, when the main dynamo was turned off and there was traffic to get ashore. Of course, where there was storage, even though it is not in accordance with the best radio ethics and is against the law, the operator has been able to get his traffic ashore without undue attention being paid to the potentate of the engine room. In days gone by, and even today, on some of the older vessels we find that there is a small dynamo driven by a steam engine and a "donkey" boiler. Did you ever know of one of these machines which could be counted upon to work when you wanted it to? Haven't you had many a walk from the radio shack, along the wind-swept deck and eventually down the slippery engine room stairs, ducking little steam lakes as you went, in order to tell the engineer on watch that you wanted to get some stuff off and that you simply had to have the juice turned on? The telephone to the engine room, even if it does run to the radio shack, which is a very unlikely possibility, does not work any too well as a rule and the engineers are not wont to answer it any too promptly when they imagine that they will have to get the small dynamo running for you. You know how it is. The wind blowing the spray all over you and soaking your clothes before you get back to the

shack, after you have told the engineer what you think of him and his family, even though you did say what you thought under your breath.

Or maybe you remember that on some of the ships you used to work on, during the few instances when there was work to be done, you were all duked up to meet some sweet little lady, in Charleston, Jacksonville or New Orleans, when you forgot that it was the day for the periodic reading of the specific gravity of the storage cells. Remember going down into the radio shack and dragging the hydrometer out of the tool box, taking a chart furnished by the storage battery company and proceeding to the hurricane deck where the batteries were kept? Opening the lid was no easy matter and then it was necessary to screw off the vent caps from every cell and take a reading of the gravity. Remember how disgusted you would get when you would come to some of the cells in which the electrolyte was not high enough for you to get enough into the hydrometer to make the reading? About the time you had covered the two banks of cells, each bank numbering 30 and the sun getting hotter every minute and your color getting softer as the sun got hotter and your temper leaving you as both these disagreeable conditions pressed themselves upon you, to cap the climax, you got some of the electrolyte on your new suit and when you went to brush it the following day you brushed a nice patch out of one of the sleeves and another out of one of the knees. Storage batteries, for auxiliary power, NEVER. Anything but storage batteries.

## GASOLINE UNITS UNPOPULAR

On some of the ships they tried the stunt of operating a generator by hooking it to a gasoline engine, but they never worked out very well; like the machine operated by the "donkey" boiler there was always something the matter with them just at the time you wanted to use them. Their reputation for reliability was about as unsavory as Ponzi's as a financier. I recall being on one ship which boasted of such an outfit. It was surely a "pippin." Every time the key was pressed, "blowie" went the juice, and every time the key was let up, the dog-goned old machine would start to fuss and fume like a "hopped" race horse. Every once in a while she would back fire and shoot out a lot of smoke and every one of the engineers was afraid to bother with it, for fear of putting it out of order. It couldn't have been put out no matter what you did to it. At any rate, it was generally out of

order and the reason they did not want to do anything with it was that they didn't want to have to be bothered with it. However, that was before the war and all the chief engineers and oilers didn't have their own automobiles to practice on, or there might have been a different tale to tell. And that brings us down to what has been done along that line, since that time.

## THINGS HAVE CHANGED FOR THE BETTER

Such conditions as I have outlined and which are common knowledge to most seagoing commercial radio men, have been so repeatedly brought to the attention of the radio companies, that they have undertaken to permit our Merchant Marine to avail itself of the improvements made in the construction of gasoline engines. The result is the production of a machine which will certainly effect economies in marine radio hitherto considered impossible.

It is interesting to know that such a machine has been placed on the Merritt Chapman Derrick & Wrecking Company's steamer *Relief*. From the illustration of the engine room it will be observed that the installation of the unit has not cut off any space which would be otherwise used and it is very accessible, which is an important point to be considered in connection with the installation of any device which goes into the engine room, especially on a small ship. A steam engine connected to the dynamo shown, or one which would deliver like power, would take up a great deal more room and would not lend itself as well to local conditions. There are many striking points to be seen in this little unit and not the least of them is that it was necessary to make a special gasoline tank which would withstand a constant pressure of 300 pounds to the square inch, for that is a rule made by the Steamship Inspection Service, and

(Continued on page 358)

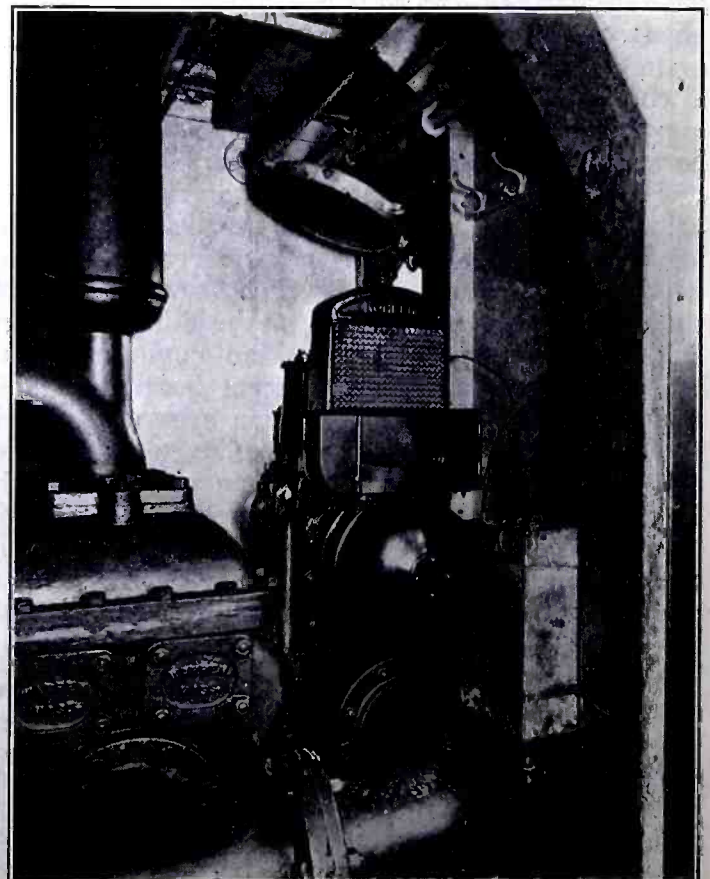

This Small Gasoline Motor-Generator Supplies the Power to the 1 K.W. Set and to the Lamps Aboard the Ship. It May be Operated From Any Part of the Ship.



# Signal Corps Valve Transmitter Suitable for Amateur Use

By E. H. HANSEN, C. E., U. S. N.

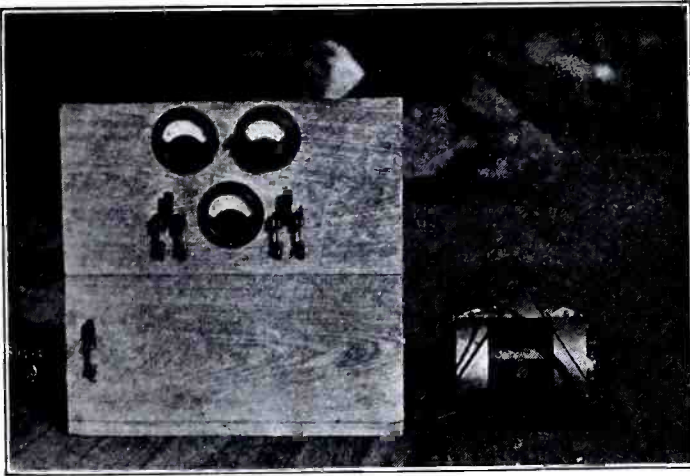

Note the Neatness and Simplicity of this C.W. Set. It is Good Looking, Although a Wooden Panel is Used.

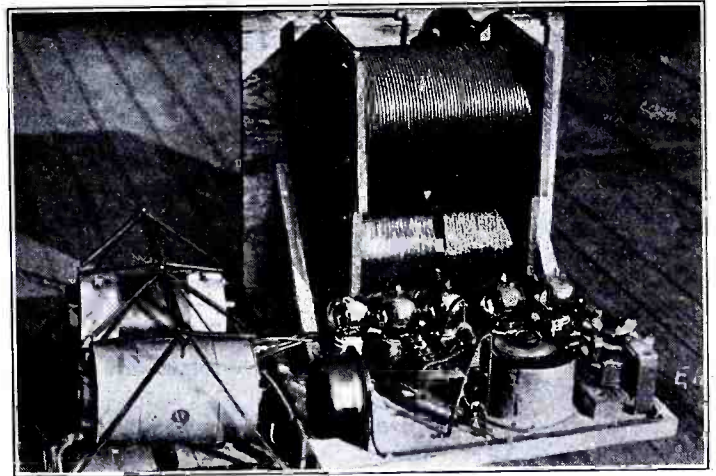

Rear View, Showing the Tubes, the Tuning and Grid Variable Condensers and the Motor Generators.

ON a recent trip to Antwerp, Belgium, I visited the Signal Corps radio station and was impressed with the simplicity and efficiency of a valve transmitter in use there. This set was originally designed by Captain Armstrong in the early days of the war and the construction of these sets was left to the operators themselves. The one at Antwerp maintains continuous communication with Coblenz, Germany, and the input is about 20 watts. As the distance is over two hundred miles, the efficiency of the set is very high. I recently built a set along the same general lines as the ones in use by the Signal Corps and believe the construction will interest amateurs. The general details are here shown by photos and a wiring diagram.

The set consists of one oscillator and four amplify-

ing tubes of the C.W. 931 type. A is the antenna coupling and consists of 120 turns of No. 16 S.C.C., wound on a frame six inches in diameter and 12" long. B is the grid leak, a carbon rod with a resistance of ten thousand ohms. C is the grid condenser with a capacity of .00075 mfd. D and E are coils consisting of 100 turns of No. 16 D.C.C., wound on a single frame double bank wound, the frame being six inches in diameter and 12" long. F is a condenser capacity 1 mfd. G is a small retarding coil. H regulates the frequency of the oscillating circuit and has a capacity of .00075. J is a milliammeter of a range from 0 to 600. K is the radiation meter

with a range from 0 to 3 meters. The plate current should have a value of between 300 and 500 volts, either D.C. or A.C., if the frequency of the A.C. is 120 cycles or more. D.C. is to be preferred, however, and the number of small motor generator units now offered for sale makes this easy to secure.

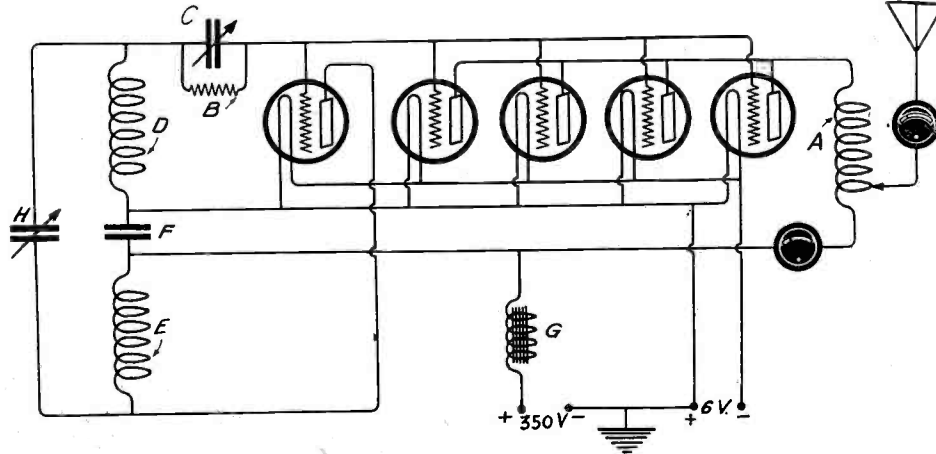

Hook-up of a Simple and Very Efficient C.W. Set That May Be Duplicated by the Amateurs. One Tube is Used as Oscillator and the Other as Amplifier.

A filament voltage of about six volts is necessary and can be supplied from storage cells. The fixed condenser F is simply to prevent the plate current side and the grid side from becoming short circuited. It has no effect on the frequency of the oscillation. The signaling can be accomplished either by insertion in the plate current circuit or by means of a compensating coil wound around coil A consisting of six turns of No. 16 D.C.C., the key shorting the free ends on the back wave.

(Continued on page 348)

## Advertising by Radio

WHILE nearly every day sees some new use to which the radio telephone may be put, perhaps none has been found more interesting or productive commercially, considering the small cost involved, than the advertising of phonograph records by an enterprising music store manager at Portland, Oregon. Charles L. Aus-

tin was accustomed each night to send out phonograph music via radiophone for the benefit of sailors at sea and any others who might wish to listen in, from his experimental station at Portland. Austin formerly was a radio operator on an ocean liner and realized the monotony of many trips and the radio-sent music proved a welcome

benefaction to many.

Clyde Freeman, manager of the Portland Remick Song shop, heard of the novel musicals, called on Austin, and substituted a new phonograph for the old one in use and the very latest in jazz dance music, songs and classics, for the collection of antiquated records. Preceding the playing of each record, an announcement is made telling the name of the record, its identification number, on what make of phonograph played and where the records may be obtained. Austin uses a 500-volt sending apparatus, the easy audibility range of which is 600 miles, although under favorable conditions reports have been made that the concerts were heard on the vessel *Reuce*, 1,400 miles from the sending station.

Many glowing claims are set forth for the radio telephonic advertising of music. It enables rural dwellers to keep up with the newest in records and music, for there are now many receiving sets throughout the country districts which can listen to the concerts. The information gathered through the air is distributed rapidly and many phonograph record sales have been made to farmers and others who have heard particularly pleasing records over the air. Many sailors who have heard the music at sea have purchased, upon calling at port. There is a new business opened up among a class of persons who never would have

(Continued on page 348)

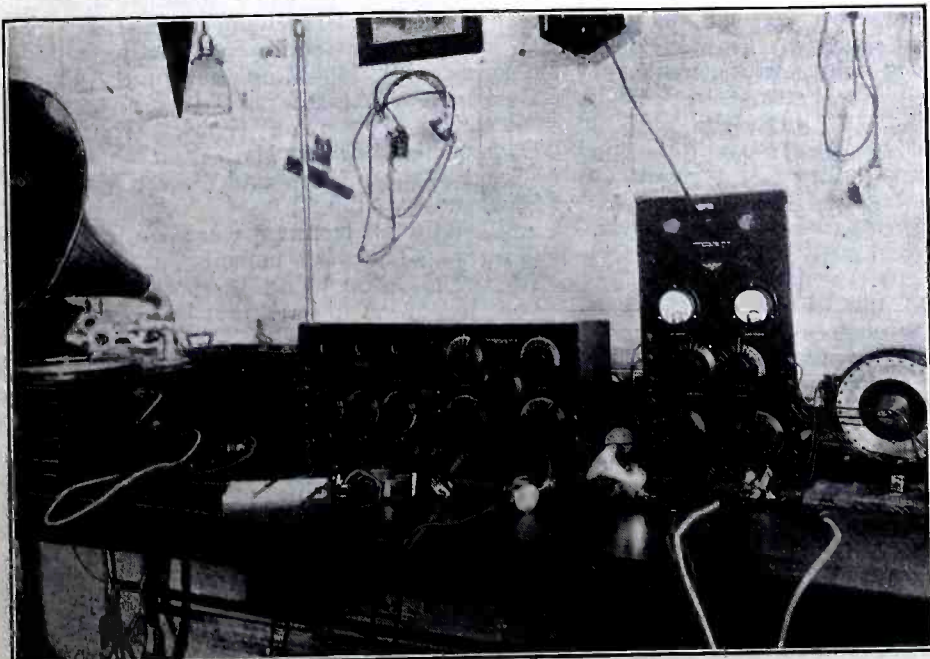

Here is the advertising station from which is sent music through a phonograph. The name of the record, its price and the name and address of the shop where it may be bought is announced before each piece. The radiophone set may be seen on the right.



# The Chicago Radio Convention

By ROSCOE SMITH\*



General View of the Radio Exhibition Held in the Broadway Armory in Chicago, Ill. Practically Every Radio Manufacturer and Dealer Had a Booth in Which Were Displayed the Most Up-to-date Apparatus for the Great Benefit of the Several Thousands of Amateurs and Professional Radio Men Who Attended This Unique Show.

**T**HE most spectacular and educational Radio Exposition ever held in the history of the loyal adherents of wireless telegraphy and telephony closed a memorable session lasting four days, at the Broadway Armory, September third.

Two thousand delegates attended the convention, the radio enthusiasts having journeyed from forty-five States, Canada and Alaska, to attend the notable event, held under the auspices of the American Radio Relay League, the gathering marking the first national convention of the Association.

More than 300 sectional clubs affiliated with the League were represented, the members of which operate more than 6,500 amateur wireless stations from Florida to Alaska, and from the Pacific to the Atlantic Oceans.

Hiram P. Maxim, inventor of Maxim's silencer and president of the Association, formally opened the convention and in his foreword gave the world a new message from the scientists in relation to the use of radiophones.

Plans were perfected at the convention for Trans-Atlantic wireless tests to take place in December, and it is expected that amateur stations in England, France and Holland will pick up the messages from America. The dominant idea is to make possible the relaying of messages by amateurs from any part of the United States or Canada to friends in Continental Europe.

That the convention was really worth while and of unprecedented scope was exemplified by its many-sided features. Some of the larger wireless clubs represented were the Ravenswood Radio Association, South Side Radio Association,

West Side Radio Club, Progressive Radio Association, The North Shore Radio Club, The Limited Radio Association and the Lane Radio Association, Chicago, Staunton Radio Club, Ridge Radio League, Blue Island Ill., The Radio Amateur Club, Carbondale, Pa., Peoria Radio Club, Central Illinois Radio School, Bloomington, Bloomington High School Radio Club, the Mt. Sterling Radio Association, Eureka Radio Club, Elmhurst Radio Relay Association and the Galesburg Radio Association.

Lectures were delivered by many notables in the radio world at several places in the North Shore district coincident with the big show itself, which never abated in its blaze of light, the eager crowds of would-be amateurs, of real amateurs, of professionals and the great crowds constituting the laymen who were attracted by the most unique show staged in Chicago in many months. All over the hall the crackling sound of the transmitters vied with one another to bring the crowds to their respective booths. Outside the great armory hundreds of automobiles had parked and their owners joined the throngs arriving hourly on surface and elevated lines, until the auditorium resembled the vanguard of a national political gathering. Fifty booths were strung along the walls of the armory and a center aisle accommodated those who could find no other space for their exhibits.

Wednesday morning ushered in the opening business and organization session of the Association at Senn Auditorium. Hiram Maxim's address opened the meeting and following this a roll call was taken of the affiliated radio clubs. (Carried previously) Mayor Thompson extended the welcome of the city to the delegates, while

J. P. Freeman, district executive of the Boy Scouts of America, outlined the progress of radio in the Scout work. The afternoon organization meeting of the Central Division was held in the Butterfly Room of the Arena (or Armory), the speakers numbering fully a dozen, in the rendering of district reports. Later in the afternoon a general business meeting for discussion of interference control, time revision regulations, traffic regulations, observation of laws and legislative matters was held at the Senn Auditorium, a series of state reports were heard, the speakers being state executives, while H. P. Maxim spoke briefly on the subject of National organization. A technical meeting was held in the evening at the same auditorium, spark transmitting and receiving apparatus topics engaging the attention of the assembled delegates, Mr. Hamilton's talk on "Antenna Designs for Amateurs," Mr. Kruse on "Practical Points on Spark Transmitter Construction," and Mr. West's subject, "Spark Transmitters and Power Factors," being noteworthy.

Educational lectures were on the program for Thursday morning, the speakers for the occasion being Prof. R. V. Achatz and H. M. Anthony, the latter selecting for his subject, "The History of Electrical Development." Practically the same program was outlined for the entertainment of the delegates Thursday as on the previous day. Thursday afternoon was given over entirely to the General Club Organization meeting at the Senn Auditorium.

Thursday evening's program covered an interesting technical meeting for purely C. W. transmitting and apparatus discussion, where everybody contributed a new idea or

(Continued on page 324)

\*Special Correspondent for Radio News.



# Transatlantic Reception Par Excellence

By WALTER J. HENRY

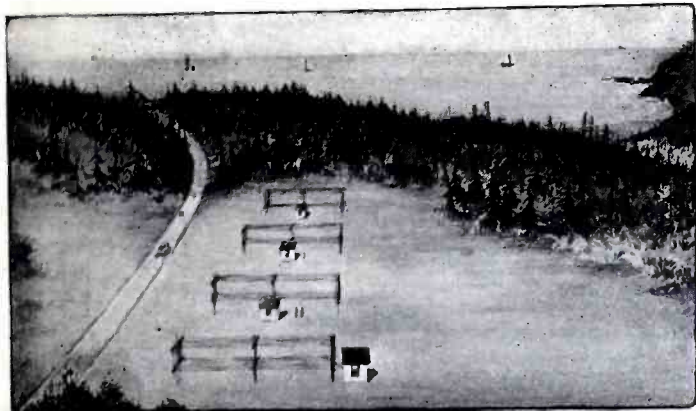

This Group of Four Stations Equipped With Very Directive Loop Aerials is Used at the Otter Cliffs Station for the Reception of Transatlantic Stations.

**C**AN you imagine a station where reception is 100 per cent. perfect at all times, where static is an unknown quantity, and where Rome, Lyons and Carnarvon come roaring in at 1,000 times audibility in the daytime? Such is the United States Navy Station at Otter Cliffs near Bar Harbor, Maine. One of the latest feats of this marvelous station was the copying of the NC-4 plane when it was off the Azores, a distance of some 1,500 miles, while the official range of the NC-4 transmitter was rated at only 500 miles. And all this work was done and is being repeated daily every hour of the 24, using only a single two-step amplifier.

One naturally wonders how such a remarkable station came into existence. During the spring of 1917, shortly after the entry of the United States into the World War, Mr. Alessandro Fabbri, a wealthy radio enthusiast, not content with donating

his yacht to the U. S. Government, wished to give a complete modern radio station to the U. S. Navy. Through Mr. H. C. Gawler, New England District Radio Inspector, he got in touch with the Wireless Specialty Apparatus Company of Boston. The engineers of this company, together with Mr. Fabbri and with the use of a U. S. Revenue Cutter, made a careful survey of the coast of Maine to

discover the best location for a radio station. The point finally selected was Otter Cliffs on Mt. Desert Island near Bar Harbor. This spot was highly desirable from a military as well as a radio standpoint, inasmuch as it was visible from only one or two points on the water.

Work was initiated at this location and in the early summer of 1917 the station was then completed. It consisted at this time of an ordinary flat top antenna supported by two towers, one 200' and one 300' high. The equipment consisted of a standard 1-K.W. Wireless Specialty commercial transmitter with receiver converter and battery charging system.

Late in the summer of 1917 it was discovered that this station was not only excellent for spark reception, but had unique reception from Transatlantic stations. It was accordingly supplied with long-wave reception coils and linked up with the

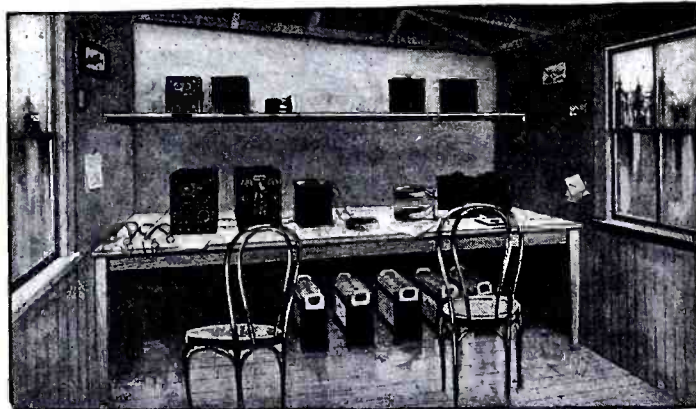

This View Shows the Inside of One of the Cabins in Which Are Installed the Receiving Apparatus, and Which are Visible in Fig. 1.

Transatlantic receiving system consisting of the stations at Belmar, N. J., Chatham, Mass., Lakewood, N. J., and Florida.

In order to attain maximum receiving efficiency it was then the rule for all of the above stations to simultaneously copy Transatlantic schedules. Belmar was the central station and the portions of messages that Belmar missed would be supplied by any of the other stations which happened to get it. If all stations missed it, a repeat was, of course, necessary.

In the spring of 1918, Otter Cliffs as well as the other stations in the system commenced to suffer from static. One day Mr. Fabbri tried the following experiment: He took some ordinary antenna wire and made a single-turn loop about a mile in diameter with the wire laid right on top of the snow. For 48 hours, perfect freedom from static was experienced, at the

(Continued on page 356)

## A Coconut Vario-Coupler



Mr. C. Sanders with the Coconut Vario-coupler He Made to Beat the H. C. of Radio Apparatus.

A distinct novelty in Radio receivers is the set built by Mr. C. Sanders, of Peckham, England, with which he is able to receive any stations in a radius of about 100 miles. The set may tune wave-lengths up to 1,700 meters and is complete in every respect.

The most interesting part of it is certainly the vario-coupler, which consists of two coconut shells of different sizes, one rotating inside of the other in the same fashion as the standard vario-coupler, used in all the regenerative sets of today. As may be seen in the large photograph, the windings of the primary were made on a form, shellacked and mounted inside of the larger coconut shell. The secondary is wound directly over the smaller shell, which is fitted with a shaft and a knob and rotates inside of the primary.

The smaller photograph shows the coupler in working order with the connections of the secondary and the aerial binding posts on the top of the shell. In the base are the necessary tuning condensers and the jacks for outside connections.

This idea of using coconut shells as forms for coils could

be advantageously used by those who wish to install a regenerative set for the coming DX season, but who have not the money to buy one of the expensive, shiny, up-to-date, short-wave regenerative sets, nor the variometers to build one themselves. A couple of coconut shells, some wire, a little patience, and you can turn out a good vario-meter or vario-coupler real cheap.

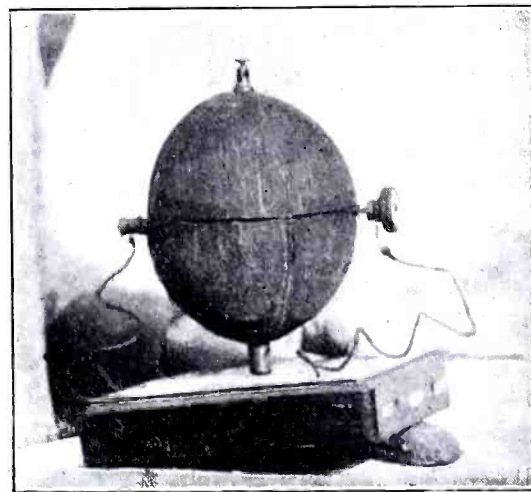

Close-up of the Coconut Receiver; Note the Jacks in the Base.

This stunt will be useful for African amateurs who live in the deserts, and if an African manufacturer would put these on the market here, they would beat all those "moulded things," for he could obtain the raw material free!



# Short-Wave Regenerative Receiver

By NORMAN A. NYQUIST

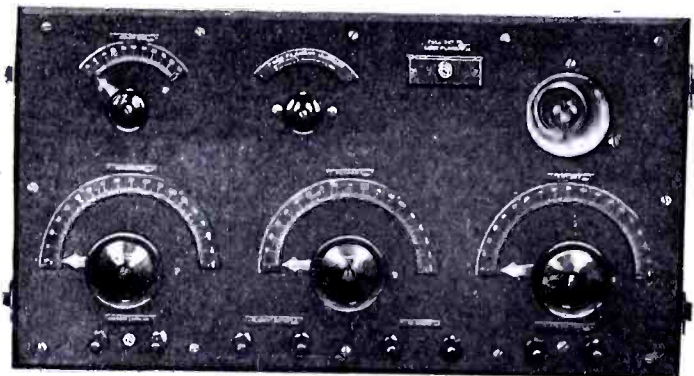

Front View of a Regenerative Receiver in Which the Capacity and Inductance of the Circuits Are Adjusted at the Same Time. A Special Mounting of the Variometers Makes This Easy.

A SUITABLE receiver was required for amateur relay work on 200 to 450 meters, a receiver that gave maximum signal strength and one sufficiently selective to exclude local interference while receiving distant stations. The following design was adapted from a Signal Corps intercept receiver, and gave excellent results on all wave-lengths between 150 and 750 meters. Tuning was very sharp and a pleasing degree of selectivity was obtainable.

Referring to Fig. 1, which shows the schematic wiring diagram of the receiver, it will be noted that the receiver and audion detector are combined in one case. The primary circuit consists of the antenna, primary variable condenser, primary variometer, primary coupling coil and ground, all connected in series.

The secondary circuit consists of the secondary variometer, secondary coupling coil and secondary variable condenser, all in series. One terminal of the secondary variable condenser is connected to the grid condenser and through the grid condenser to the grid. The other side of the variable condenser runs to the negative side of the filament battery and completes the secondary circuit.

There is a tertiary circuit, making the receiver of the Armstrong regenerative type. This circuit simply consists of a third tuning circuit similar to the secondary circuit, allowing the plate circuit to be tuned, for regeneration or to produce oscillations to receive undamped signals. It will be noted that the tertiary variometer and tertiary variable condenser are connected in parallel. One side of the tertiary variable condenser runs to the plate; the other side runs to the positive side of the high potential battery, and from the negative side of the high potential battery to the telephones, through the phones back to the negative side of the filament battery. A by-passing fixed condenser is connected around the high potential battery, and telephones to provide a path for the high frequency oscillations which would otherwise be impeded by the high resistance of the phones and battery. This completes the entire circuit with the exception of the positive side of the filament battery, which should be run through a suitable filament current rheostat to the other filament terminal. A very satisfactory rheostat for this purpose is made by the Adams-Morgan Company.

Now, in regard to the construction of this receiver and its novel features: the primary-secondary coupler is shown cross-sectionally in Fig. 4, and is shown in the photograph in the right-hand upper corner of Fig. 3. It consists of a fixed tube  $3\frac{1}{2}$ " in diameter fastened to the back of the panel. On this are wound 10 turns of 3-16 No. 38 Litzendraht

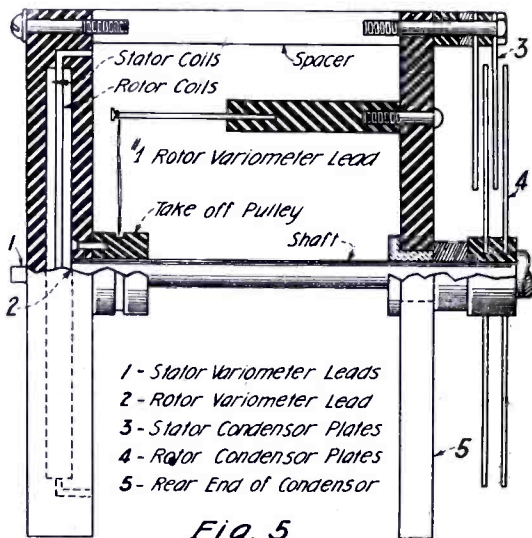

Fig. 5 Detail of the Variometer Mounting on the Condenser Shaft.

wire and then varnished. The movable coil is  $2\frac{1}{4}$ " in diameter and has 12 turns of wire, six to a layer. From the drawing and photograph it will be noted that a 90-degree range of coupling can be obtained from the zero point and that a 10-degree range of coupling can be obtained in the negative position. This feature is to overcome any fixed primary-secondary coupling that may exist, due to the manner in which the receiver is wired externally.

The most important part of the receiver is the construction of the variometers. These variometers are mounted on the same

shaft as the variable condensers. An ordinary variable condenser has a minimum to maximum capacity ratio of two and one-half to one. Likewise an ordinary variometer has a minimum to maximum inductance ratio of two and one-half to one. Placing a variable condenser and variometer in

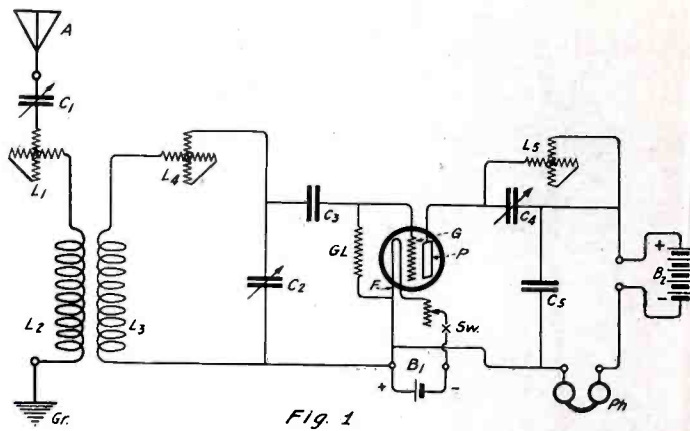

Fig. 1 Complete Hook-up of the Set With Indications of the Various Parts.

parallel, and both on the same shaft, working from minimum to maximum simultaneously, we get a wave-length range of at least five to one. In the antenna circuit we have a little different condition. The condenser and variometer are in series with the antenna and ground, which is really a condenser and a wave-length range of only about five to one can be obtained. But in the closed circuits such as the secondary and tertiary circuit, and using specially shaped plates and good variometers, a range of eight to one can be obtained.

Fig. 5 shows cross sectionally the construction of a variometer and the manner in which it is attached to the variable condensers. It is seen that one dielecto disc is fastened permanently to the back of the variable condenser by three spacers. This dielecto disc holds the stationary coils of one variometer. Another dielecto disc is attached to the variable condenser shaft. Only one take off pulley is required to bring out one lead of the movable coil. The other lead of the movable coil is connected to the shaft of the variable condenser. The shape of these coils is shown in Fig. 6, which also shows the manner in which they are connected.

To wind these coils, a brass form is made, with the sides removable so as to remove the coils from the form after they are wound. However, before removing the coils they should be dipped in ceresine wax, form and all left to cool, so that the coils retain their shape. All the coils are wound with 3-16 No. 38 Litzendraht. The primary coils consist of six turns per coil (four coils per variometer, two stationary and two movable), two turns per layer and three layers. The primary coil has more turns than the other coils, as this variometer is in series with the antenna and antenna condenser and requires more inductance.

(Continued on page 312)

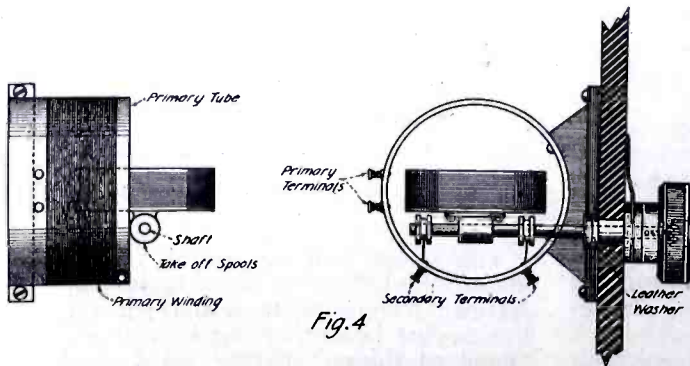
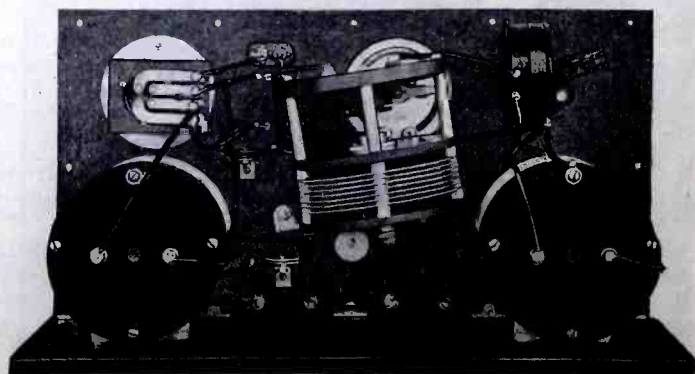

Fig. 4 Constructional Details of the Variocoupler.



Rear View of the Set. Note That the Secondary Variometer and Condenser Are Mounted at Right Angles to the Other Circuits.



# Radioteleinscription

By AUSTIN RIU

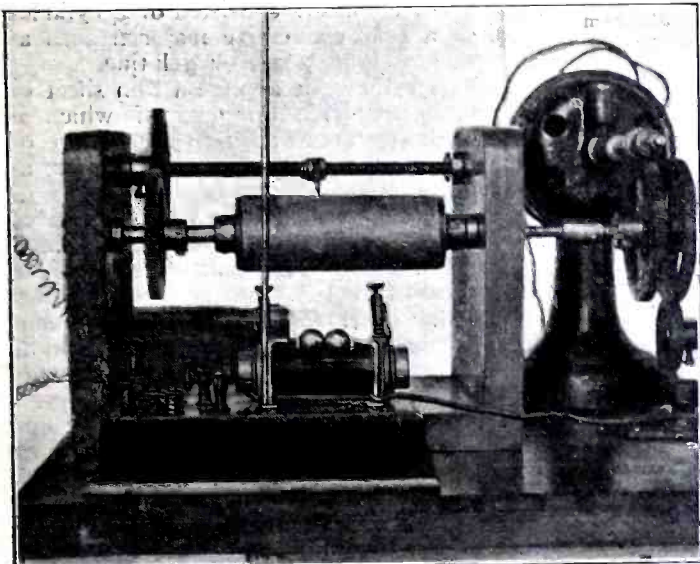

On the left is the transmitting apparatus for the transmission of pictures by radio. The spark coil and gap may be seen fixed on the base supporting the whole set. On the right is the receiver with the coherer and writing device mounted on the electro-magnet armature.

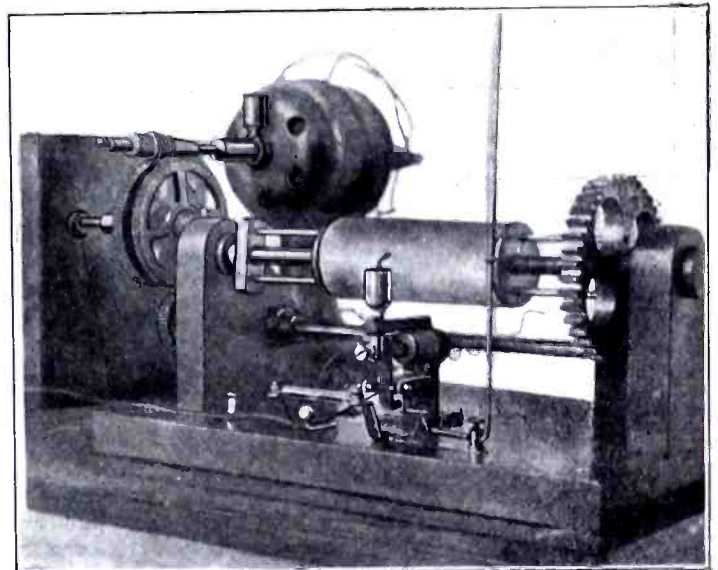

I SHALL endeavor in this article to describe a simple instrument that I built myself and which can be used for the transmission of drawings, documents or writing.

In this experimental set, the new improvements of Radio were not considered and I used a Branly's coherer, which gave me very good results. Of course, if continuous waves were used with, at the receiving end, an amplifier and relay, the distance over which messages could be sent would be very much increased, but for experimentation, I did not judge it necessary to complicate the set to such an extent.

The construction of the transmitter and receiver is not very complicated for an amateur possessing a few tools and having enough hand-practice to turn out successfully a work of this kind.

As may be seen in the diagram and on the photograph, Fig. 1, both transmitter and receiver consist of a cylinder having a constant angular velocity. The only delicate point is to adjust the speed of the motors in the two stations so that they run constantly at the same speed. A centrifugal regulator helps considerably in keeping the speed constant.

Referring to the diagram, it may be seen that when the cylinder of the transmitting instrument runs, the two gears R run the screw S, displacing the piece E along the cylinder, in the same way as the diaphragm in the old-fashioned phonograph, thus exploring the whole surface of the cylinder.

At the receiving station, the cylinder runs at the same speed as the transmitter, moving with two small rods SR and the axis screw AS. The transmitter cylinder is made of copper and is electrically connected with the two gears R. When it is desired to send a document, a map for instance, it is first written on the cylinder, or a sheet of tinfoil, which is applied upon it with insulating ink, then the device is started at both sending and receiving stations where a sheet of white paper is glued on the cylinder. When the needle of the piece E is in contact with the copper cylinder, the electromagnet B attracts the lever

in the same way as the diaphragm in the old-fashioned phonograph, thus exploring the whole surface of the cylinder. When the needle of the piece E is in contact with the copper cylinder, the electromagnet B attracts the lever

circuit. The contact F then closes the circuit of the primary of the induction coil and a train of waves is sent through the aerial.

At the receiving station this wave train impresses the coherer, closing the circuit of the battery P, and the electromagnet BR attracts the lever bearing the ink-well and pen supplied by capilarity, and marks a dot on the white paper covering the cylinder.

It is easy to understand the complete process, which is a repetition of what was just explained, the drawing, map or writing being reproduced by dots very close together, forming continuous lines and reproducing perfectly anything which is set on the transmitter.

It is important, in order to obtain accurate reproduction, to use a screw having a close pitch, as the screw S should move the piece E very slowly, so that it explores every spot of the cylinder while it rotates.

In the instrument I built, the cylinders have a diameter of 2 1/2" by 4 1/2" long; with the screw S having a pitch of .02", four minutes are required to send a full drawing covering the cylinder entirely.

Some other devices could be used for the transmission of pictures by Radio. A system using a selenium cell and small electric lamp would prove interesting to experiment with.

We would be glad to hear from experimenters who build such instruments and receive photographs and descriptions of their apparatus.—Editor.

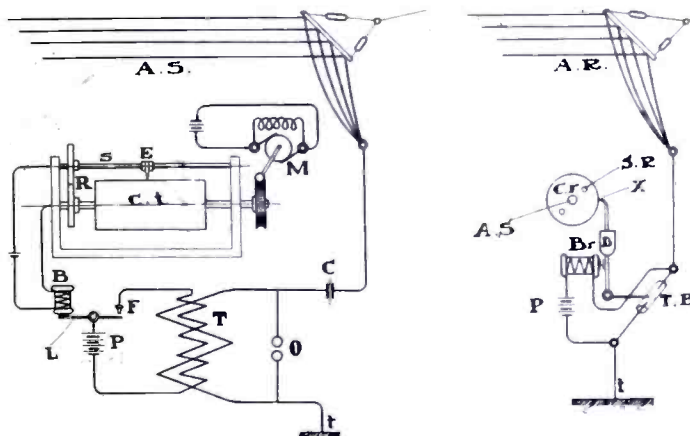

Diagram of Connections of Both Transmitter and Receiver.

L, but releases it when the needle comes in contact with the insulating ink, cutting the

## DX Reception Without Antenna or Ground

By WILLIAM LEYH

IT may be of interest to the readers of RADIO NEWS to learn of a new field open for Radio research work, that of recording signals without antenna or ground. Just how it is accomplished and the benefit derived, I will try to make clear in the following paragraph on this interesting subject.

After a great deal of experimenting with various types of apparatus, and under different conditions, I have succeeded in copying amateur, commercial and high-powered, long wave stations, with the everyday short-wave regenerative receiver and detector two-stage amplifier up to a distance of 500

miles, which is by no means the limit, and I hope by publishing this for the benefit of the rest of the Radio Fraternity, the distance will be greatly improved upon, in the near future.

The apparatus used in the test consisted of an ordinary short-wave regenerative receiver, such as is found on the market

today, with detector and two-stage audio frequency amplifier, with a wave-length range of 150 to 350 meters. The diagram below will explain the circuit used.

The coupler consists of two tubes of cardboard. The primary is 4" outside diameter, 3 1/2" long, wound with 42 turns of No. 20 D.C.C. copper wire. Secondary is 3 1/2" outside diameter and 1 1/2" long, wound with 32 turns of No. 22 D.C.C. copper wire. No taps are taken off, as the only tuning to be done is with the coupling of primary and secondary variometers.

The variometers are standard and may be bought on the market also. (Continued on page 316)

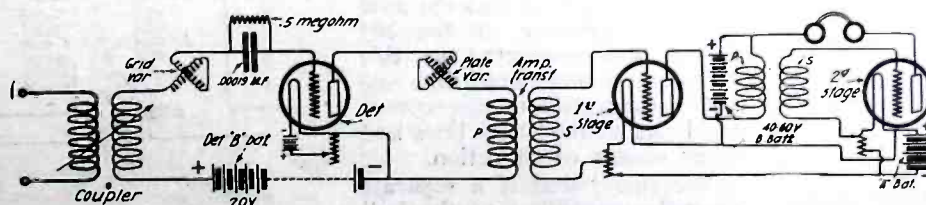

Complete Hook-up of the Set and Amplifier Used by Mr. Leyh in His Experiments of Reception Without Aerial. The 20V. Detector "B" Battery and the Connection From the Filament Should be Inverted so That the Positive be Connected to the Transformer.



# A New Loudtalker

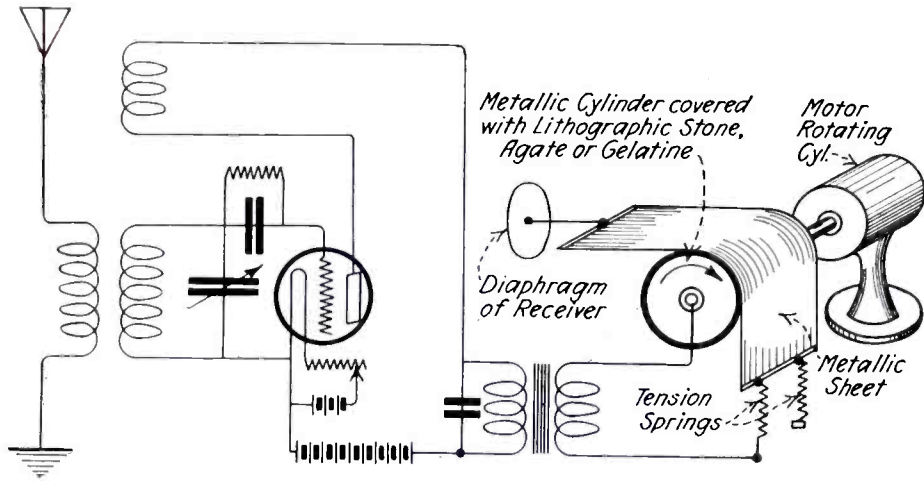

This diagram shows the loud talker illustrated on the front cover of this magazine, connected to a radio receiver. The functioning of this instrument may be understood by referring to the sketch.

## THE STONE RELAY

The first experimental apparatus built by the Danish engineers consisted of a cylinder cut into a semi-conductive material such as lithographic stone, agate or gelatine.

On this cylinder is applied a thin sheet of conducting material, one end of which is fitted with springs to adjust the pressure of the surface in contact with the cylinder, as shown in the diagram. The other end of the sheet is connected to the diaphragm of the receiver. When the motor runs the cylinder, if a current is applied between the sheet and cylinder, the attraction effect causes the sheet to stick to the cylinder, pulling it in its rotating motion. As soon as the current is cut off, the sheet is released and it comes back to normal position.

If the current impressed on the sheet and the cylinder is a variable current, such as a telephonic one, produced by the speech, the attraction between the sheet and the cylinder will vary constantly, transmitting its motion to the telephone diaphragm attached to one end of the sheet. The effect being greatly magnified, a very strong sound is emitted by the telephone receiver, acting as a loud talker.

In the former experiments, it was found that using a disc 2" in diameter fixed to the arm of a balance and applied to the stone with a potential of 400 volts between the electrodes, it required about three pounds to pull the disc apart. The current flowing through the apparatus was extremely minute.

In some experiments tried with a stone relay, a violin was used as a resounding box and attached to the sheet instead of a telephone diaphragm. Both music and speech were clearly and strongly reproduced. Of course, many other applications may be found for this interesting novelty, and opens a new field for experimentation along new lines.

**R**ECENTLY two Danish engineers, Mr. Johnsen and Mr. Rahbek, made public a new phenomenon, an electrical attraction, a result of their researches.

In fact, the phenomenon itself is not new, as it was mentioned about 40 years ago by Thomas A. Edison, but has been forgotten since, and Messrs. Johnsen and Rahbek have not only rediscovered it, but also found several interesting and practical applications.

The phenomenon itself may be explained as follows: If, for instance, a metallic disc is placed on a lithographic stone and a difference of potential of a few hundred volts is applied between them through another electrode placed on the other side of the stone, a very weak current of a few microamperes flows through it.

While this weak current flows in the circuit, a strong adherence is produced between the stone and the disc. It is thus possible to obtain a very strong attraction with a very weak current.

Messrs. Johnsen and Rahbek give as an explanation of this peculiar effect that the two electrodes act as the plate of an air condenser, the difference of potential between the two surfaces being due to the very high resistance of the contact. The result of this is an electrostatic attraction corresponding to the attraction observed between the plates of an air condenser, in which the attraction is inversely proportional to the square of the distance between the plates.

In the experiment carried out by the two engineers, the distance between the two surfaces was very small and the attraction very strong. Among the various substances they tried as a semi-conducting medium, may be mentioned gelatine covered with an aluminum sheet and agate.

As may be understood, this attraction effect may be utilized in the construction of a relay, since with a very weak current, such as telephone currents, some powerful mechanical effect may be produced.

## A Common Cause of Induction from the Ship's Dynamo and Its Remedy

By STANLEY EDGAR

**O**N a great many vessels induction in the receiver from the ship's dynamo is a constant source of annoyance to the operator. The continual grind in the telephones is a terrific strain on the nerves and is frequently so loud that it is impossible to read certain signals through it and renders the use of audio-frequency amplification impracticable.

My partner and I experienced these conditions on the S. S. *Mongolia*, and for almost a year tried every means and experimented with every hook-up of which we had ever heard for the elimination of induction, without much success. We had almost given up in despair when we succeeded in solving the problem and locating the chief cause of this induction. As in this regard most shipboard sets are installed in the same manner, I am convinced that

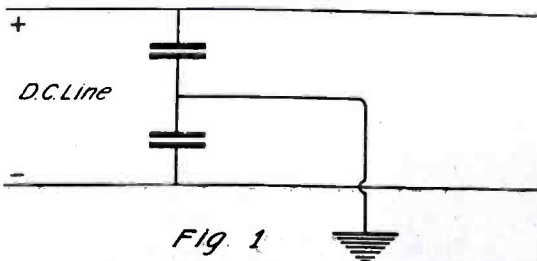

This Device, Installed Aboard a Ship, Decreases the Induction From the Dynamo, Causing a Humming Sound in the Receiver of the Radio Station.

the cause and remedy herein described will apply on other ships where induction is a troublesome factor.

The cause and remedy are so simple that it seems as though they must be generally known, but the fact that the *Mongolia* and other ships have for years been known as "induction" ships and that many unsuccessful attempts have been made to eliminate this induction, seems to indicate that this is not the case.

Our set was installed, as seems to be customary, with only one main "ground" to which was attached, by means of one common copper strip, the ground connections of the transmitter and of the receiver, the high-frequency protective devices, the leads covering the various D. C. and A. C. lines, the transmitter panel, etc.

We found that the chief cause of induction was the fact that the primary of the receiver was connected to this common ground and thus directly connected to the covering leads of the D. C. lines and other causes of induction.

We found that if a separate ground, connecting to the hull of the ship some distance away from the main ground, was used

for the receiver, induction was practically eliminated. In practice we utilized for our receiving ground the steam radiator in the wireless room, which passed through to the next deck and connected to the hull at some point remote from the main ground connection.

The slight induction which remained was eliminated entirely by the following means:

(1) Connecting a large capacity condenser to each of the main D. C. lines with their

(Continued on page 314)

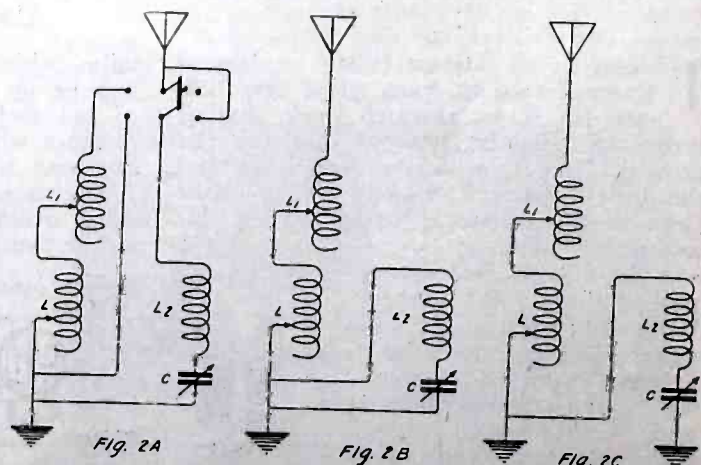

Using These Circuits Enables the Operators Aboard Ships to Cut Out the Induction From the Supply Line, so Detrimental to Good Reception.



# The Super-Differential Circuit

By LEONARD HANSON

**T**HE theory of the super-differential circuit is advanced to promote the possibility of eliminating certain kinds of interference as encountered during the reception of Radio signals. It is believed static, as well as an interfering station, can be completely eliminated should the static and interfering station be at a certain angle from the receiving station.

If you follow the theory closely you will surely agree that static and other interference originating in these certain zones will be completely eliminated and further, there should be no decrease in the strength of signals desired to receive, should the circuit be adjusted correctly.

To get at the base of the theory let us say for example:

We have an inverted "L" antenna placed North and South, and due North some few hundred miles is the station we desire to receive from; his sending wave is 2,000 meters, but there is also a strong station working on 2,000 meters due Northeast of us and his signals "come in" equal in strength with the station due North of us—to copy either of the stations would be a useless attempt as long as the two are sending at the same time.

In our first attempt to eliminate the interference caused by the station Northeast of us, we bring a "loop receiver" into play. We will place the loop receiver in a position so that its plane will be East and West—with the loop in that position you will agree that we cannot receive signals from the station due North of us, but the station to the Northeast will be audible on the loop receiver about one-half of its normal value. We will now go back to the inverted "L" receiver and tune it also for 2,000 meters and then connect the plate circuit of each receiver to the differentially wound transformer, that is, connected so the current received in one of the plate circuits will oppose the flow of current received in the other plate circuit.

Then when we connect the phones across the secondary of the transformer, we find that the station due North of us "comes in" with its usual strength while the station in the Northeast "comes in" with a strength of about one-half its usual audibility.

Now, by referring to Fig. 1, we will find the "hook-up," and the theory of operation may be as follows:

Receiver No. 1 (the inverted "L") receives full strength signals from the North station which is sending on a 2,000-meter wave and also receives strong signals from the Northeast station, which is sending on a 2,000-meter wave, while the loop receiver No. 2 receives no signals from the North station, but receives semi-full strength sig-

nals from the Northeast station. As the signals received on each receiver oppose each other at the differential transformer, and there being no opposing signals for the station due North of us, the differential circuit lets these signals pass, while the signals on the loop receiver are one-half the value of the signals received on the inverted "L" receiver, hence the opposing signals are of one-half value; therefore, the differential transformer cuts the interfering signal to one-half their former value.

Right here you may say "we gain nothing of practical value, as with the loop receiver alone we can eliminate the station Northeast of us and receive the station due North with a receiving current of about one-half its normal value." In that we agree, but I maintain that it should bring out another idea: As we have half-way eliminated the interference caused by the station working to the Northeast we may completely eliminate it by replacing the inverted "L" receiver with another loop receiver. Let us suppose then that we replace the inverted "L" receiver with another loop receiver; we will now place the

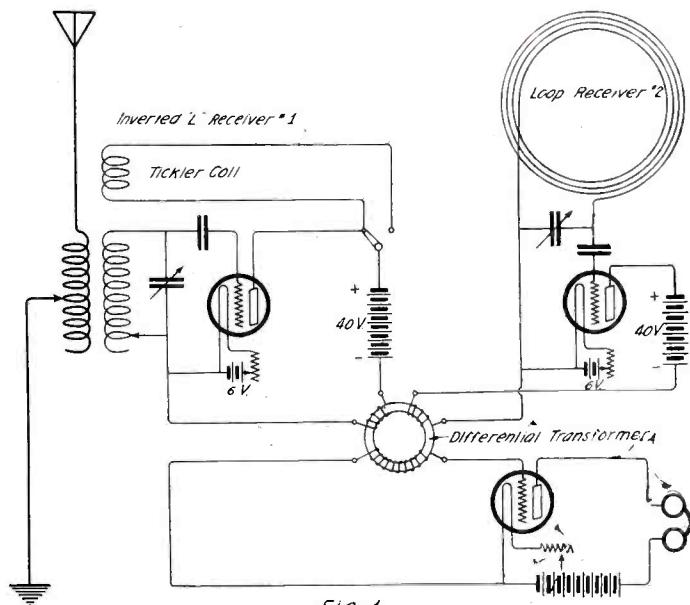

Fig. 1  
Using a Loop Aerial in Conjunction With a Regular Receiving Set, and a Differentially Wound Transformer Helps to Cut Out Interference From Stations Sending on the Same Wave-Length.

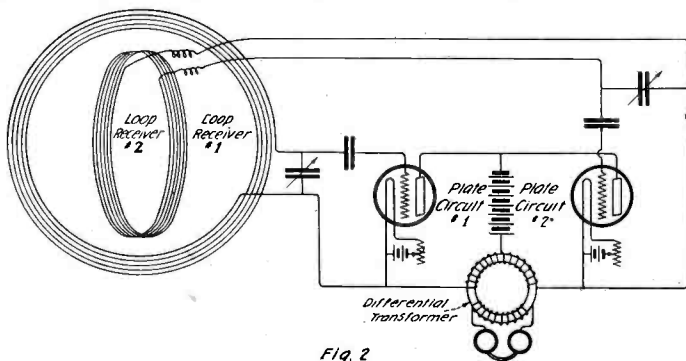

Fig. 2  
Instead of an Aerial and a Loop, Two Loops May be Used, Giving a Greater Selectivity.

loop receiver No. 1 as shown in Fig. 2 with its plane in the direction North and South. We will let the loop receiver No. 2 stay in the same plane of direction East and West. Now, by tuning each receiver for a 2,000-meter wave, we will be able to hear the station due North of us with a full strength signal, while the station Northeast of us cannot be heard when the phones are connected to the secondary of the transformer winding, due to the fact that the signals are balanced out; however, each loop receiver gets that station with equal current strength, although one-half its normal strength, due to the same angle of each loop from the Northeast station.

This brings out another point of the theory, as we will find that any number of stations working on 2,000 meters, which lays in the directions Northeast, Northwest, Southeast or Southwest, will be completely eliminated; or again, stations working on 2,000 meters which lays off the true North, South, East or West directions will be partly, if not completely, eliminated. Further, static interference would be completely eliminated should the point of their origin lay in the Northeast, Southwest, etc., directions from our receiver. May the

question be asked, "Who knows where the static oscillations originate?" Surely, they originate at certain angles from our antenna. At least then, we must concede that one-half of the static interference will be eliminated.

There will be no heterodyne effect produced between the two receivers due to the fact that the loops are at right angles from each other and secondly, due to the fact that each receiver is tuned to exactly the same wave-length.

It will be found possible to receive and send at the same time on the same wave-length by closely balancing out the sending station's current; however, the loops would have to be at right angles from each other as usual, and the balancing adjustment would have to be made by bringing one loop closer or further away from the vertical aerial "lead in" wires, until the point is found where each loop receives the same amount of current from the sending aerial.

Now, by referring to Fig. 3, we will simplify the super-differential circuit by making it so that its adjustment can be more readily made. We will employ two loops of the same inductance, one placed inside of the other, but at right angles from each other. Now any station in a direction parallel to either loop can be received with full strength signal, but any station with an angle of direction from the true parallel of either loop will be eliminated directly proportional to the angle from parallel to either loop. That is, the stations completely eliminated will be stations whose directions lay in the angles of 45, 135, 225 and 315 degrees from either loop. This will be understood by the fact that any stations within these angles from our loops will induce simultaneously the same amount of current in each loop and the loops are connected so that this current set up in one loop will oppose the flow of current set up in the other loop. Therefore, complete elimination of these stations will take place, and it is obvious that static interference originating in these certain angles will be completely eliminated.

It would prove interesting to experiment with this circuit on amateur and commercial wave-lengths in districts where Radio traffic is heavy in order to receive DX stations in spite of statics and interference.

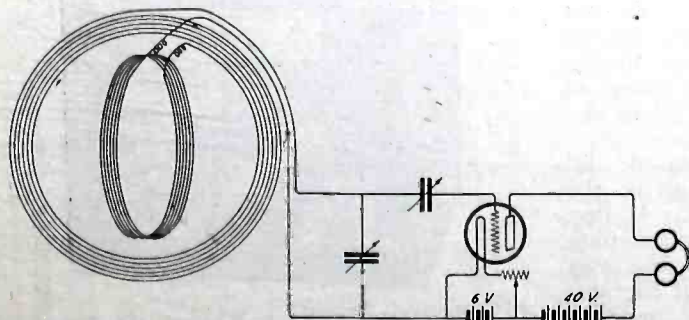

Fig. 3

This Circuit is the Same as Fig. 2, But Simplified so That Only One Tuning and Detecting Circuit is Needed.



# New Radio Apparatus

## Dial Rheostat

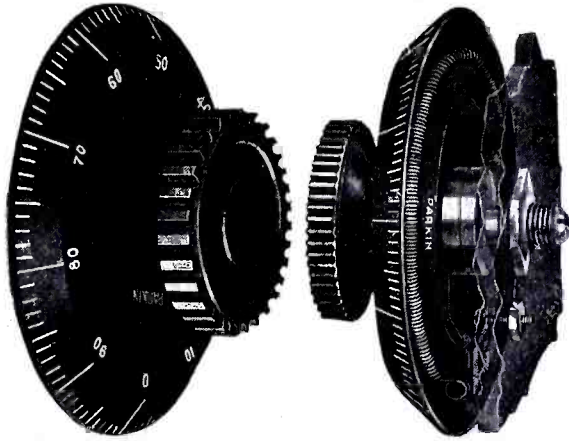

This Combination Dial and Rheostat Saves Space Inside of a Cabinet and Has a True 360° Reading Scale.

A new combination of a rheostat mounted inside of a dial, has recently been developed by a firm whose specialty is this kind of instrument.

As may be seen in the photograph, the groove containing the resistance element, being recessed in the back of the dial, allows the latter to clear the panel by the usual distance of  $\frac{1}{8}$ ". A brass bearing insures a true running dial and smooth action. The resistance element is a spring of non-corrosive resistance wire and may be replaced, if burned out. An "off" position is provided and a stop on the dial engages the stationary contact at the extreme positions. The rotation of 360 degrees insures a fine adjustment.

The main advantage of this new type of rheostat is that it saves space inside of the cabinet and requires only two holes drilled in the panel to mount it. The resistance is 5 ohms, with a carrying capacity of 2 amperes.

Photos by courtesy of Parkin Mfg. Co.

## A New Type of Variable Condenser

Among several other types of variable condensers, which could be seen at the Chicago exhibition, is the model here illustrated, which is a radical departure from the rotary type. The dielectric is of mica and the two armatures open as a book. The capacity is varied by increasing or decreasing the distance between the two plates; this is accomplished by a cam mounted on the shaft, and a spring which pulls back the movable plate when the cam is turned, so that the distance between the plates increases.

The main advantage of this condenser is simplicity, as there are no complicated parts

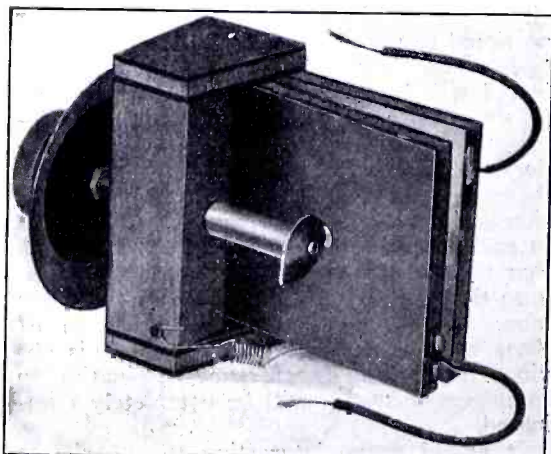

This Type of Variable Condenser Has a Mica Dielectric and May be Used in Low Power C.W. Circuits.

to manufacture, thus the cheapness of this instrument. The mica insulation makes it possible to use this condenser in low power C.W. sending sets, and for reception, it may be used in circuits where capacity of .0005 mf. is required, although the real capacity of the condenser is about .0007 mf., with a minimum of .00006 mf.

Good contacts with the armatures are obtained through soldered leads mounted on the condenser and which are used for connections with the outside circuit.

Photo by courtesy of Crosley Co.

## Filament Control Jacks

In accord with the general trend of the times, which is away from the multiplicity of switches which marked the "big set" of former days, is brought forth by the Federal Telephone and Telegraph Company the so-called Filament Control Jacks.

The Filament Control Jack does not differ

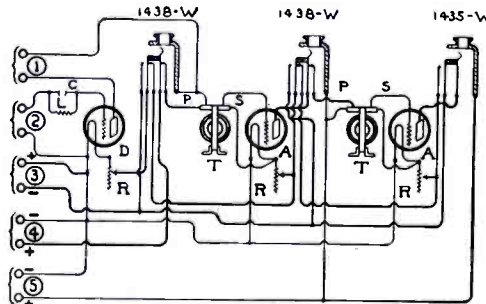
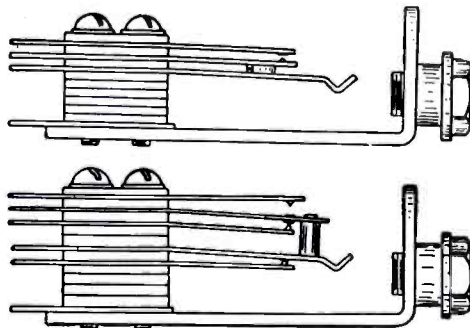

DETECTOR & 2 STAGE AMPLIFIER USING FILAMENT CONTROL JACKS

- NOTE
- 1 - TO TICKLER COIL
  - 2 - TO SECONDARY
  - 3 - TO 'A' BAT. 6 VOLTS
  - 4 - TO 'B' BAT. 18 TO 30 VOLTS
  - 5 - TO 'B' BAT. 40 TO 60 VOLTS
  - C - 3581-W GRID CONDENSER
  - D - DETECTOR TUBE
  - L - 250-W 2 MEG GRID LEAK
  - A - AMPLIFIER TUBES
  - R - RHEOSTAT

Using These Jacks in an Amplifier Circuit, Only the V.T.'s Used Are Lit Up Automatically When the Phones Are Plugged in, as May be Seen in the Hook-up.

in construction from other types of standard telephone jacks, but its use in the hook-up given by the accompanying figures is a recent development which is due to the engineers of this company.

The function of the Filament Control Jack is to obviate the necessity for filament current switches for detector and amplifier tubes. It also eliminates switches between amplifiers and between amplifier and detector. A saving in filament current which is wasted under customary operating conditions by leaving bulbs burning while not in use. With this system, pushing in the phone plug connects the receivers to the circuit at the detector or desired stage of amplification and lights the bulbs, all in one operation.

If noting Fig. 1, it is desired to use detector, simply push receiver plug in the first jack and first bulb will light. If first stage of amplification is desired place plug in second jack, both detector and first step amplifier bulbs will now light and the station will operate with one-step amplifier. Similarly for added stages of amplification.

Diagram by courtesy of the Federal Tel. & Tel. Co.

## An Improved "B" Battery



In This New "B" Battery, Any Cell May Be Replaced and the Voltage May be Varied by Steps of One and a Half Volts.

All of those who use some block type, 22½ V. "B" batteries, know the disadvantage inherent of the sealed batteries, as only one bad element may put a whole battery out of service, as the block is sealed, and cannot be easily repaired, nor refilled.

In a new model of plate battery, recently placed on the market, the connections between the cells are accessible, making it possible to change one element, which is either discharged or defective and to clean the contacts, if necessary. The advantages claimed by the manufacturer are: First, the possibility of varying the voltage of the entire unit by steps of 1½ volts; second, perfectly noiseless operation, due to good material and special electrolyte used in the cells; third, the possibility to replace any cell which may be obtained separately, from the dealers.

This last advantage is certainly a great improvement, as it is possible to use all the cells until they are really down instead of throwing away a good many of them which could still be used, as so often happens with the sealed type of battery.

Photo by courtesy of the Hipwell Mfg. Co.

## Complete Radio Receiver for Beginners, at a Popular Price

In order to popularize Radio and make it possible for everybody who is interested, to experiment with a real Radio set, a manufacturing company of well-known reputation has developed a complete outfit, selling for a low price, which is within the reach of all.

The outfit comprises a receiver of the single circuit type, equipped with a crystal detector and having a range of wave-length of 175 to 2,600 meters, making it possible for the experimenter to receive amateurs

(Continued on page 357)



This Receiver Having a Wave-length Range of 175-2,600 Meters is Supplied With All the Necessary Parts to Erect a Receiving Station. It is Simple in Operation and Will Certainly Help to Popularize Radio.



# Show Your Goods

By ARMSTRONG PERRY

**T**HE most wonderful thing about radio is the number of people who have never yet seen a set or heard a signal. Next to that comes the number of radio dealers who sat in their shops last summer with all kinds of apparatus stacked high on their shelves, the "bills payable" spindle full and the order spindle empty.

Every time I visited a radio store that was in the doldrums, my fingers itched to get hold of some of the regenerative receivers that were bringing in nothing but duns and interest charges and take them out to show them to some folks I know and to some whom I don't know, but would like to.

By showing apparatus, I mean to demonstrate it so that the person to whom it is shown will realize that he can operate it himself and get some fun out of it.

The way radio dealers show their goods sometimes resembles the method by which the American Museum of Natural History shows its seismograph for recording earthquakes, but it is not so good, because you can't see the wheels go round in the radio sets that stand in shop windows and show-cases. The seismograph sells itself, aided by a plain description illustrated with diagrams and posted conveniently near. You look it over, read the description, explain it to your wife just as convincingly as though you knew what you were talking about, and agree with her that it is a great machine.

Now that is as far as the seismograph needs to go. There is no use of starting a slogan: "A seismograph in every home." If any earthquake shock occurs that is heavy enough to interest common folks they will not need any apparatus to advise them of its arrival. But why leave radio receivers in the same class with seismographs?

It is not enough to have people look on and say "Oh!" and "Ah!" and "Isn't that marvelous!" To stop there is like bringing your best girl to the point where she looks soulfully into your eyes and exclaims: "I think you are perfectly wonderful!" and then failing to ask her the all-important question. There is no profit in exclamations. It takes sales to bring in the shekels.

The way to get the "O-O's" behind a decimal point on a check, with some figures on the other side of the point, is to follow a principle which is as old as the hills. Professional educators discovered this principle after practical people had been using it for twenty odd centuries, and they named it "the educational cycle of activity," so that it would sound like a brand new thing. The simple fact behind the high-sounding title is that a person can see a thing, hear a sound, smell an odor, feel and taste all sorts of things, without their making any great impression on his mind or changing his habits. As long as everything is coming in—through his eyes, ears, nose, tongue and skin—and nothing going out, he is like the dead sea or the quicksand, always swallowing, but doing no good. But the instant you give a man an outlet so that the incoming impression is expressed in action, you complete the educational cycle of activity, and habits begin to form.

When you take a man who is gazing interestedly at a radio receiver and put

his hands on the controlling knobs, you have formed an outlet and completed the circuit. It may be as small as the first trickle of water that left Lake Erie in pre-historic times and ran off in the direction of Lake Ontario, but that first trickle washed out a little channel that became the bed of the Niagara River, and the river cut a path for itself through solid rock and now produces kilowatts enough to supply all the radio stations in the country. The channel that you start in the mind of a man by getting him to act on the interest which your apparatus has aroused is something which even he cannot eradicate. It is an unchangeable law of mind that an impression received through the senses, reinforced by an action on the part of the muscles, produces association fibers in the brain which make that impression permanent. Thereafter that man can never see a piece of radio apparatus without thinking: "I tuned in a signal once." It establishes an interest which means a sale just as soon as he meets a salesman who finds out how to adapt apparatus and terms to the conditions surrounding the prospect. It may require time and effort to broaden and deepen that channel of interest so as to get the most out of it. You may cut in a two-step amplifier and a loud speaker

everybody can be interested in. All you have to do is to show a man that he can work the set and hear something.

Just think offhand of the number of places where radio apparatus could be demonstrated with only the expense of transportation; where a demonstration could be offered as an act of helpful courtesy and be received with grateful enthusiasm and very likely with a check to cover expenses.

There is a publication called "World Convention Dates," in which every line is a suggestion. Take a national bankers' convention, for example. Would any convention committee turn down an offer to install radio service at the convention hall? I doubt it. Men find a peculiar satisfaction in saying, "We got that by radio," for it sounds, and is, up-to-date.

The grocer could not get in with an egg exhibit unless he had golden eggs and took along the goose that laid them, but the radio man could go and the bankers would thank him for going.

He could give them the weather forecasts and press. He could arrange for getting through messages for prominent delegates via the A. R. R. L., or other relays, and for passing back convention news of local interest to home newspapers. With proper preparation he could let them hear some great European station transmitting news that any financier would be mighty glad to get an hour ahead of the other fellow. Would that interest them? Try it! Put up a set in your local bank and bring in a few quotations.

With a loud speaker on the guest table at the convention banquet, a radiophone transmitter somewhere and a few tips from the convention joker, he could stir up fun enough to make up for the after-dinner speeches. If he was wise enough to get the right banker, a radio novice with common sense and a sense of humor, to operate the set on the table, he would score a clean bullseye, and one shot in the little black ring does more business than a

targetful of ones and twos.

Every convention brings together its own peculiar types of men and its own group of radio opportunities. Every hour of the day there is a chance to do some influential man a favor by giving him a brief explanation of radio and letting him operate the receiving set himself. Men remember with especial distinctness courtesies extended when they are strangers in a strange town. Every man who goes home from a convention and reports as one of the high spots: "A fellow showed me how to use a wireless outfit, and it wasn't as hard as I thought it would be," is as valuable an advertisement as the model who wears the new style gowns up and down Fifth Avenue. He gets a lot of people thinking about radio and then they notice the ads and the window displays and their interest grows and begins to lean toward the dotted line where purchasers sign.

The fact that these strangers go back to spread radio propaganda in their own towns instead of the dealer's, will not worry the man who shows his goods at conventions with a far-seeing eye. There must be team-work, of course, each man covering his own territory for the general benefit of the business. It all equalizes in

(Continued on page 336)

---

**H**ERE is another of Mr. Perry's "corkers." We would advise every amateur to read it carefully. Any Radio dealer who misses reading this article will be out a small fortune. Here is an article both for the amateur, and for the dealer as well. While Mr. Perry does not say so, every amateur can read between the lines that here is the chance of a lifetime for him to go out and hustle. There is not a Radio dealer anywhere who would not be glad to employ a dozen amateurs on a commission basis to do the work as outlined by the author.—Editor.

---

and then only be able to sell a galena detector and a single 75-ohm phone, but if you will get that far and follow it up and make sure that the little set brings in something, there surely will be other orders to follow.

Taking care of the man who comes to your shop is at the present stage of the game like depending upon trout to swim down through your gutter to be caught. A grocery store man only has to figure on his location. Everybody has to eat and he only has to get in the way of the maximum number of hungry folks in order to give himself a chance. The radio dealer must do more than that. He must take his goods to the people. He cannot even depend upon their looking in at his window display.

It seems like a disadvantage, but is it? The men who pack and sell groceries must continually cudgel their brains to produce some new idea—a name or a package or some product distinctively better. The fellow who sold just eggs a few years ago has had to learn to sort his hen fruit and invent catchy designs to conceal the fact that they all come out of the same crate. Eggs are an old story and there is no romance or thrill in price and quality. But the radio man has something that is new to almost everybody, something that



# A Study of the Antenna System

By C. M. GRABSON

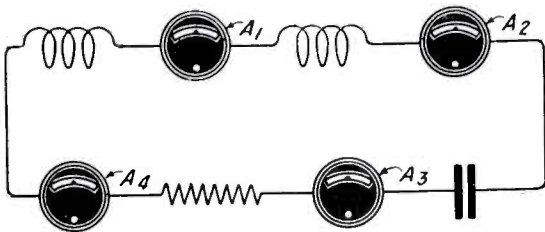

Fig. 1

In This Circuit Having Some Inductance, Capacity and Resistance, the Ammeters Would All Read the Same if an H.F. Current Flowed in the Circuit, for it is a Closed One.

IT is the object of this paper to present for amateurs a brief explanation of the fundamental principles underlying the antenna system. Too generally, the amateur's idea of the antenna consists solely in regarding it as a capacity and an inductance and stops there. While it is true that it may be so regarded, there are other details in the theory of the antenna system which clarify this conception and contribute to a better comprehension of the subject, and will enable the amateur to explain a great many of the antenna phenomena which he reads about and bucks up against. The antenna should be understood no less thoroughly than any other part of his radio set, and this article will assist in such an understanding.

The antenna, as is well known, is an open circuit, i. e., its circuit is not closed by a lumped inductance or capacity, but is closed by the capacity or condenser formed by the antenna structure and the earth. It may, therefore, be simply represented by an equivalent closed circuit consisting of a concentrated inductance and capacity. There is, however, one important difference between the antenna system and an equivalent closed circuit. This difference may be

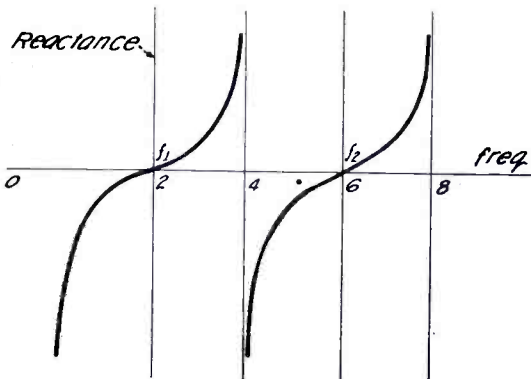

Fig. 5

Reactance Curve of an Aerial for Various Frequencies.

shown as follows: In the closed circuit in Fig. 1, suppose we place ammeters at the points marked A1, A2 and A3. If a radio frequency current flows through this circuit and the ammeters are all alike, the readings registered by each ammeter will be the same. In other words, in a closed circuit formed by a lumped inductance and capacity, the current is the same at all parts of the circuit. However, in the antenna system represented in Fig. 2, the conditions are entirely different. If we were to place ammeters at various points along the antenna, as represented, we would find that the meters all read differently, but in a consistent way. The meter near the ground would read a maximum and the meters further along the antenna would read less, the nearer the top the smaller the reading. The reason for this is that the antenna system is one in which the constants of inductance and capacity are not concentrated, but dis-

tributed along the length of the antenna. This is shown in Fig. 3, where the distributed capacity and inductance is represented by dotted figures. Thus the current leaks through the distributed capacity at various points along the antenna to ground, and so the current in the antenna varies from point to point. Similarly the voltage along the antenna will vary from point to point. This variation of current and voltage along the antenna is capable of being represented by curves, and in the case of the simple vertical antenna shown in Fig. 4, the variation is shown by the two curves along its length. These curves show that at the base of the antenna the current is a maximum, while the voltage is zero (ground potential) and at the top of the antenna the current is zero while the voltage is a maximum. Thus the voltage and current differ in phase by 90 degrees. This oscillation is that of the fundamental wave-length of the antenna. The antenna may oscillate at other waves, as for

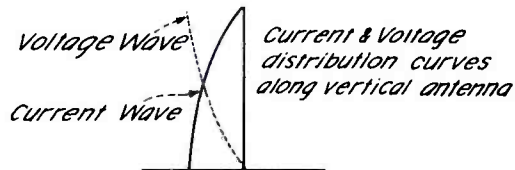

Fig. 4

This Sketch Shows the Value of the Voltage and Intensity Along an Aerial.

example at its harmonics, and the form of the current distribution will be slightly different, but the current must always be a maximum at the ground and the voltage a minimum, while at the top the conditions are reversed.

In speaking of the capacity and inductance of an antenna, generally these terms are very loosely used; thus, there is the static, low frequency, and high frequency inductance of an antenna. Similarly there is the static, low frequency and high frequency capacity of an antenna. These terms will be made clear by the following explanation.

## CAPACITY

If the antenna under discussion were uniformly charged along its length to a given potential, that is, if each unit of length of the antenna were at the same potential as every other unit of length, then each unit of the antenna would carry the same charge of electricity and the capacity of the antenna thus obtained is the "static" capacity. This condition is arrived at by charging the antenna with a source of constant potential or by a very slowly varying potential. This "static" capacity is thus the same as the low frequency capacity of the antenna. However, when the antenna is traversed by a high frequency current or charged by a high frequency potential, the distribution of the potential is not uniform along its length, as seen from the voltage distribution curve of Fig. 4. Consequently, the high frequency capacity is different from the "static" or low frequency capacity. In calculations of

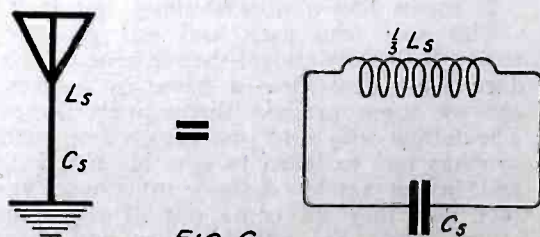

Fig. 6

An Aerial is Equivalent to the Closed Circuit on the Right Having Inductance and Capacity.

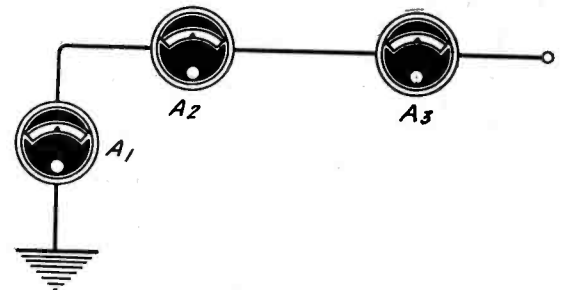

Fig. 2

If Ammeters Were Inserted at Various Points Along the Aerial, They Would All Read Differently for the Reason Illustrated in Fig. 4.

the capacity of condensers and antennae it is usually the low frequency capacity which is calculated.

## INDUCTANCE

In a similar way, if a D. C. generator were inserted in the lead-in of the antenna, the current flow along the antenna would be the same at all points of the antenna. Thus there would be a magnetic field produced, which would be the same at any point of the antenna. The inductance thus obtained is again the "static" inductance of the antenna. However, for alternating currents, the current is not the same along the different points of the antenna, as seen from Fig. 4. Consequently there is a difference between the "static" inductance of the antenna and the low frequency and high frequency inductance. The inductance of coils, which is calculated by the usual formula, is the low frequency inductance. There is a correction which has to be applied to the low frequency value in order to obtain the high frequency inductance, but sometimes by proper design this correction may be made negligible.

There is, however, a definite relationship

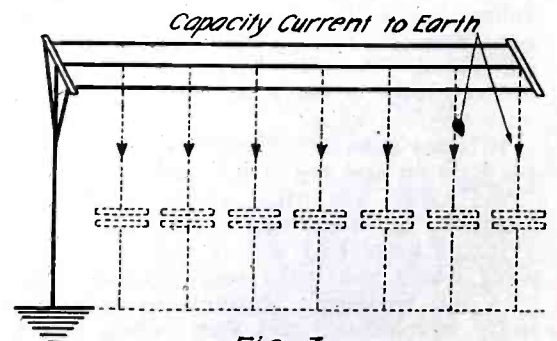

Fig. 3

This Sketch Illustrates What is Meant by Capacity of the Aerial. It is the Same as if it Was Connected to Several Condensers, as Each Point Along the Antenna Has a Capacity Varying With the Distance to the Ground.

between the "static" inductance and low frequency inductance of an antenna. Without going into the mathematics of the question, it may be said that it can be shown that the behavior of the antenna is similar to a reactance whose curve is a standard cotangent curve, shown in Fig. 5. By an analysis of the equation of this curve, it is found that the low frequency inductance of an antenna is one-third the value of the "static" inductance of an antenna. Thus if the "static" inductance be represented by  $L_s$  and low frequency inductance by  $L_f$ , then

$$L_f = \frac{1}{3} L_s$$

Consequently, since the "static" and low frequency capacity of the antenna are the same, an antenna of "static" capacity  $C_s$  and "static" inductance  $L_s$  may be represented by a closed circuit of capacity  $C_s$  and inductance  $\frac{1}{3} L_s$ , as shown in Fig. 6.

Much important information about the behavior of radio frequency circuits may be

(Continued on page 332)



# Awards of \$100 Radio Accessory Prize Contest

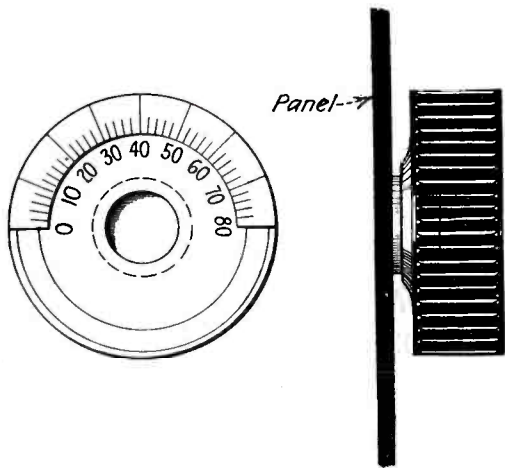

For Small Sets or Other Purposes, This Knob is Very Convenient; it Has the Scale Engraved on it, Thus Doing Away with the Dial.  
—Designed by Richard Baker.

## FIRST HONORABLE MENTION. An Improved Binding Post. By Frank Dieringer.

The binding post using a thumb nut to hold the wire fast is one of the most commonly used binding posts. It presents a good appearance on a radio set, but when one turns the thumb nut down in order to fasten a wire under it, the wire has a tendency to follow around the binding post. When this occurs the connection may not be a good one. The binding post which I will describe eliminates this disadvantage. It operates on the principle of a vise. It presses the wire without dragging it around the binding post.

The stem of the binding post "M" in figure "A" has two flats filed or milled on it. These flats are parallel to each other. On this particular binding post the distance across the flats is  $7/64$ " and the diameter of the stem is  $11/64$ ". A washer is made of brass  $3/2$ " thick in which the hole at the center is made to fit the stem of the binding post. The diameter of the washer, before the edge is turned over in this case is  $11/8$ ".

Figure "B" shows the washer before the edge is turned over. The next operation is to put the washer in place on the stem of the binding post, then screw the thumb nut down tight. The edge of the washer is turned up over the lower shoulder "S" in figure "D." This can be done with a hammer. (If this was to be put on a productive basis, this operation would very likely

be done by machine.) After the edge of the washer is bent over all around, the next thing to do is to chuck the binding post in a lathe or on a drill press in order to polish the washer. To improve the appearance of the binding post, the washer can be nickled. The binding post is now ready for use. When the thumb nut is turned so as to raise it, the washer will raise with it, but since the hole at the center of the washer is made to fit the stem of the binding post, the washer will not turn around. Therefore, the only movement of the washer is up and down. It acts like a vise, for it presses the wire without dragging it around the binding post.

## SECOND HONORABLE MENTION. Luminous Scale for Dials. By Philippe A. Judd.

The idea I submit to the accessory prize contest consists of a dial with luminous scale and numbers.

Instead of filling the numerals and lines engraved in the bakelite with white lead, I propose to fill them with luminous paint, as already done on several other things. Thanks to these luminous dials a set could be tuned in darkness or when in a place

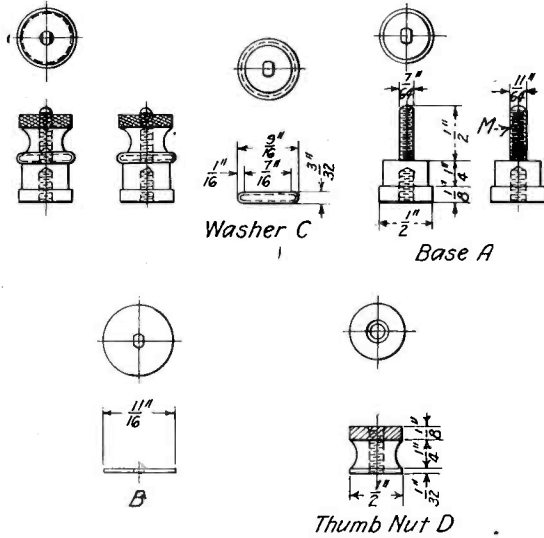

A Washer Sliding Along the Threaded Rod of This Binding Post Presses the Wire Flat and Prevents its Being Twisted Around When the Thumb Nut is Screwed Down.  
—Designed by Frank Dieringer.

where the light is not very good such as in camp, etc.

The formula for the luminous paint is:

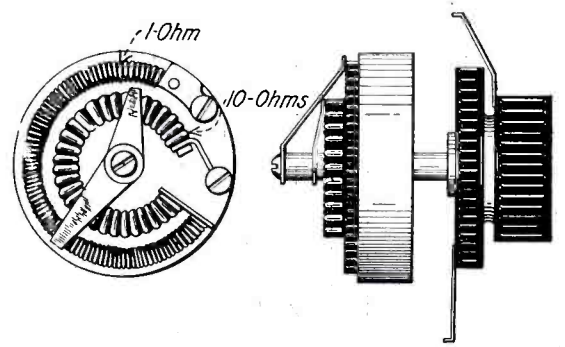

Here is a Rheostat With Vernier for Tube Requiring a Fine Adjustment of Filament Current.

—Designed by Rudolph R. Young.

Strontium Thiosulphate . . . 60 parts (WT)  
5% acidified alcoholic solution of bismuth nitrate . . . 12 parts (WT)  
5% alcoholic solution of uranium nitrate . . . . . 6 parts (WT)  
Mix, dry and heat for 1 hr. at  $2,372^{\circ}$  F.  
The color of this solution is emerald.

## THIRD HONORABLE MENTION. An Improved Filament Rheostat. By Rudolph R. Young.

In the sketch shown above may be seen the new type of rheostat I designed and which is fitted with a vernier adjustment. As may be seen two resistances are mounted on the same base, one has a value of 10 ohms and the other of 1 ohm. The two blades are connected to a concentric shaft and may be controlled separately.

A rough adjustment is first made with the 10 ohm resistance and a very fine adjustment is obtained with the 1 ohm unit. This is especially useful for tubes having a critical adjustment.

## FOURTH HONORABLE MENTION. Knob Scale Combination. By Richard Baker.

I wish to enter this idea in your prize contest. The object is to put the scale on ordinary knobs, instead of having dials. The knobs can be any style or any size, although they should have a smooth surface near the edge for the engraving. Any size scale can be put on the knobs of course. These knobs would be especially adaptable to portable sets where they would take the place of large awkward dials or big scales, and although being smaller they would give as much efficiency.

# The Production of Continuous Oscillations in Circuits Which Contain Capacities of High Value

By JOHN SCOTT-TAGGART

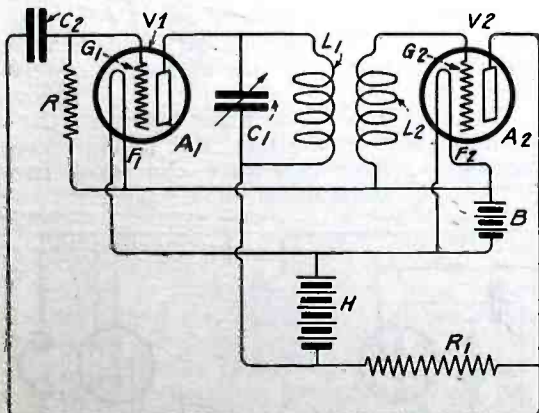

Fig. 1

With This Circuit Undamped Waves of Any Wave-Length May be Generated. A Range of 100 to 80,000 Meters May be Obtained by Adjusting the Value of the Condensers C1.

It is frequently desirable to produce a source of oscillating current which may be adjusted between wide ranges of frequency by the simple continuous action of a variable condenser. The most usual circuit for the production of continuous oscillations with a three-electrode vacuum valve involves the use of a retroactor coil which operates only over a certain range of wavelengths. This range may be considerably increased by winding the retroactor coil with resistance wire, but even so it is not possible to cover the wide ranges to be achieved with the circuits about to be described. Apart from the question of the retroactor, if we turned our oscillatory circuit with a condenser we would find that, when the capacity of the condenser was above a certain value, the vacuum valve would cease to oscillate.

The circuits shown in Figs. 1 and 2 may be used for the production of oscillations of

practically all frequencies. For example, with a variable condenser having ebonite dielectric and a fixed inductance of small value, a range of from 100 meters to 30,000 meters was obtained solely by adjusting the  
(Continued on page 318)

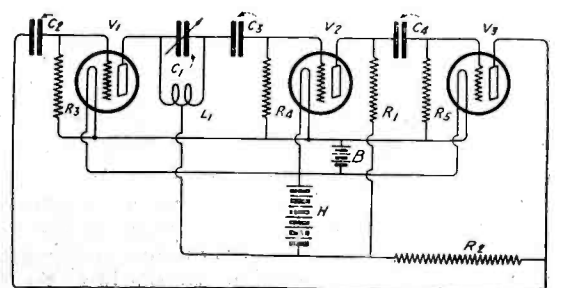

Fig. 2

This Circuit Works on the Same Principle as the One in Fig. 1, But an Amplifier is Used to Boost Up the Oscillations Produced.



# Long Wave Reception

By VICTOR ANDREW

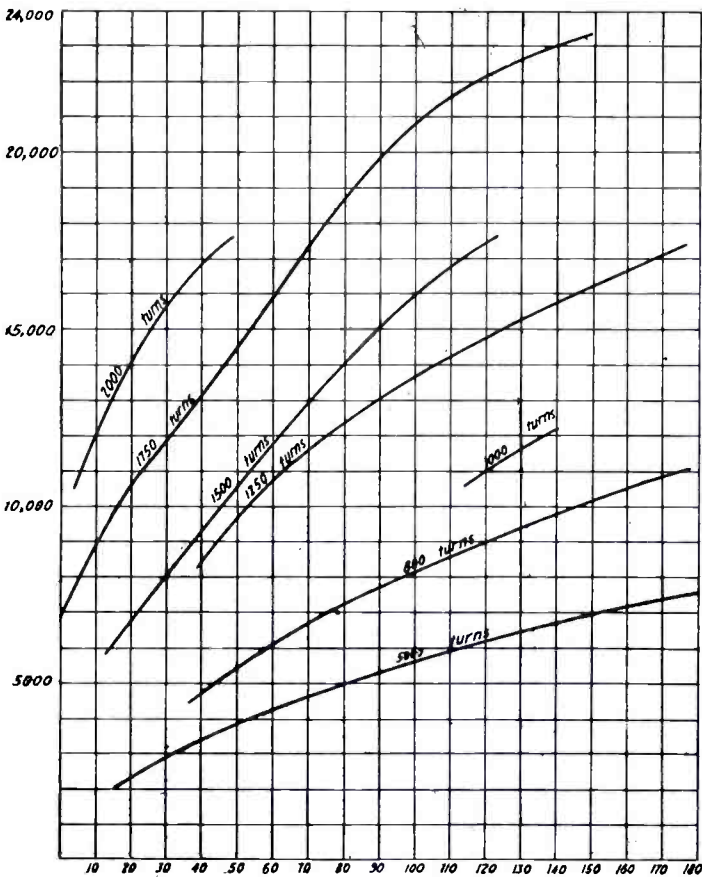

Wave-length Chart for Long Wave Reception Showing the Wave-Length of Each Coil When Used With a .001 Mf. Variable Condenser.

IN current Radio magazines there is a lack of information concerning long-wave reception. If there is a complete, up-to-date list of high-power undamped stations giving call letters and wave-lengths, I would be very glad to get a copy of it. The information following may be of value to others interested in undamped work.

I have copied the following undamped stations, using one bulb and the standard three-coil circuit with hand wound duolaterals. Other wave-lengths are used by these

stations, but those given are those actually copied.

When NSS and WGG are both working, NSS heterodynes WGG so that he can be

Location	Call	Type of wave	Wave-length
Bordeaux, France	LY	b	23,410
Annapolis, Md.	NSS	b	17,300-10,000
Tuckerton, N. J.	WGG	a	about 16,800
New Brunswick, N. J.	WII	a	13,600
Marion, Mass.	WSO	a	11,500
Sayville, L. I.	NDD	b	11,600-9,800-7,800
Arlington, Va.	NAA	a	about 11,000-6,000
Cayey, P. R.	NZR	c	about 11,000
San Diego, Calif.	NPL	b	9,800
Balboa, C. Z.	NBA	b	7,000
San Francisco, Calif.	NPG	b	about 6,000-4,800
Key West, Fla.	NAR	b	6,500
Guantanamo, Cuba	NAW	a	about 6,000-4,500
New Orleans, La.	NAT	c	5,500
Bermuda, W. I.	BZR	a	5,000
Hampton Rds., Va.	NAM	c	about 5,000-2,400
Santo Domingo, Dom. Rep.	NJG	b	about 5,000
Barry, U. S. Navy	NIC	c	about 5,000
Charleston, S. C.	NAO	b	4,700
—, Nova Scotia	VAL	a	about 4,500
—	KDCM	a	about 2,400
—	KDDJ	a	about 2,400

The "type of wave," a, b or c, indicates whether the compensating wave is also transmitted or is absorbed; "a" indicates that it is not heard, "b" that it is shorter than the working wave, and "c" that it is longer than the working wave. When the compensating wave is shorter than the working wave, tune below the zero beat to read the higher tone, and when it is longer tune above the zero beat.

Undamped stations are also audible on various harmonics. WSO and WGG are always heard on twice their wave-lengths, and NSS is frequently heard on  $\frac{1}{2}$  and  $\frac{1}{64}$  his wave, on about the same wave-lengths as amateur C.W. sets. Harmonics of NDD and NZR on amateur waves are also quite common. Harmonics of half the natural wave-lengths of undamped stations are most frequently heard.

read on a non-oscillating set. The change in NSS's wave-length from working to compensating makes WGG's signals waver.

Here in Ohio the loudest stations are WGG, NZR, WSO, NDD, NAA and NAM, with NSS, NAW, NAO, WII, and NAR ranking second. WSO works almost continually with LCM or POZ. NDD, WII, and WGG are also working most of the time. NSS sends time signals at noon and 10 P. M. and Navy Press after 10 P. M.

The capacity wave-length charts are of hand-wound coils, so are not likely to coincide exactly with any machine wound coil, but the 1,750 turns is only a little larger than the US-1500, and the 500 is practically the same as the US-500 machine wound coil. The vertical figures are the wave-length, and the horizontal figures are the degrees on a .001 condenser (Illinois).

By drawing capacity wave-length curves for each coil it is easy to identify unknown (Continued on page 326)

## Design of Short-Wave Regenerative Receiver Without the Use of Variometers

By W. R. SNYDER\*

THE writer having some odds and ends of material on hand, consisting mainly of a beautiful black walnut box, 12" x 9" x 9", a few feet of litz, a .001 variable condenser, a "Mac-Mal" squirrel cage rheostat, together with a varied assortment of other radio junk, decided to enter into the field of the short-wave regenerative receiver. This inspiration was due, mainly, to the fact that the black walnut box, mentioned above, was unsuited to any other purpose from the writer's standpoint, and also through a desire to listen to the many short-wave concerts, now so frequent in this locality.

As the general scheme was strict economy, the use of the variometer type regenerative circuit was immediately stricken off the program. So, in casting about for a suitable circuit that would enable the design to conform to the economical conditions, as well as to the limited dimensions of the box, the Eaton oscillator type circuit was decided upon, and in addition it was to be slightly modified to include a magnetic plate coupling

arrangement, so that close regulation of the tube operation could be obtained. It must be confessed that at the outset, the writer was not imbued with any great expectations of performance. However, to say the least, the results were very, very satisfactory, and it is believed better performance was shown with this circuit arrangement than has been witnessed with other short-wave circuits, without exception.

Following are the features of design as incorporated in the receiver built by the

writer. Owing to the small dimensions of the box, it was decided to limit the range of frequencies to a very small band, namely: from 150 meters to 250 meters, since the receiver was to be used solely for amateur frequencies, unnecessary inductance and the consequent losses in switches were eliminated.

The first step taken, after fitting a quarter-inch panel to the box, was to cut down the .001 variable condenser and make two (Continued on page 324)

Hook-up of a capacity coupled regenerative receiver, with one-step amplifier.

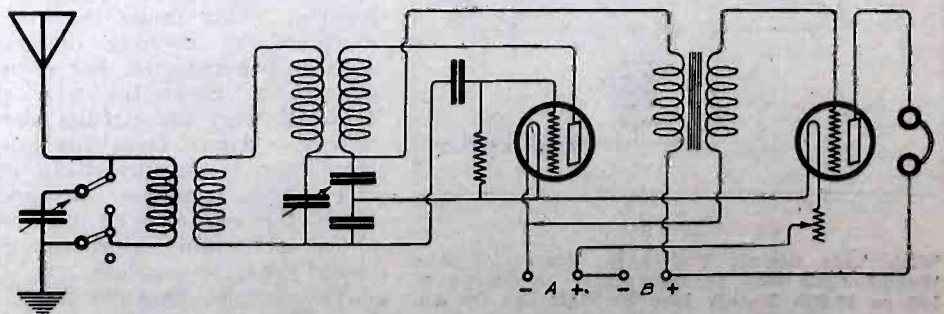

\*Foreman, Radio Installation, Union Iron Works



# The Basket Woven Coil

By GEORGE ADAMS

THE basket coil is not sufficiently well known in this country and its advantages for short-wave work are not realized enough for it to be popular with the amateur. Basket woven coils were designed by Allied radio engineers during the war when a coil of short wave-length was desired, which would give very loose coupling for use with tube circuits.

This article will describe a simple though somewhat tedious method of winding these coils, but any trouble taken will be amply repaid by the results obtained.

The wire is woven in and out of round pegs mounted on the periphery of a central core, which is generally known as a "spider" (Fig. 1). A spider cut from  $\frac{1}{8}$ " bakelite, as in Fig. 2, can also be used although, owing to a smaller number of divisions, the latter has not such a large inductance as the former.

The former may be made from a piece of round wood 1" in diameter and  $4\frac{1}{2}$ " long, with 13 pegs of steel or brass rod  $\frac{1}{8}$ " in diameter. The holes drilled in the spider should be about  $\frac{1}{2}$ " from the end and should be spaced evenly around its circumference. Any odd number of pegs may be used above 13, the inductance of the coil depending upon the number of pegs used in the spacing of the turns.

The reason for specifying an odd number of pegs is so that alternate turns will follow the same wave—1, 3, 5, 7, etc., following the same wave and 2, 4, 6 and 8 following the opposite wave.

To commence winding, fasten the wire

around one of the pegs and take the wire in and out around the pegs, see Fig. 3. When starting the second turn, the wire will be around the pegs the opposite way to the first turn, and all successive odd-number turns will be on the same side as No. 1, while even-number turns will be on the same side as No. 2. Wind evenly until the coil has the required number of turns, then dip the whole in a bath of melted paraffin wax, drain, and allow it to set. When set hard, the pegs and core may be removed, leaving the finished coil as in Fig. 4. If the pegs have been made to fit too tight in the core, they will be very difficult to remove, and there will be a risk of damaging the coil in taking them out.

With this kind of coil, it is not possible to calculate the inductance accurately; one must determine it by experimenting. The author has used No. 20 to No. 28 B. & S. gauge wire for various coils, some of which measured as follows:

	B. & S.			
Coil A	15 pegs	26	70 turns	400 mhs
" B	13 "	24	200 "	3260 "
" C	17 "	28	300 "	5000 "
" D	13 "	24	70 "	275 "

Coil D, with a .001 mfd. condenser, has a wave-length range of from 143 to 518 meters, and ranges of other coils with various condensers can easily be calculated. Three coils such as D, using one as a tickler, can be combined in an ideal short-wave amateur tuner, say for relay work. A receiver like this used for C.W. work

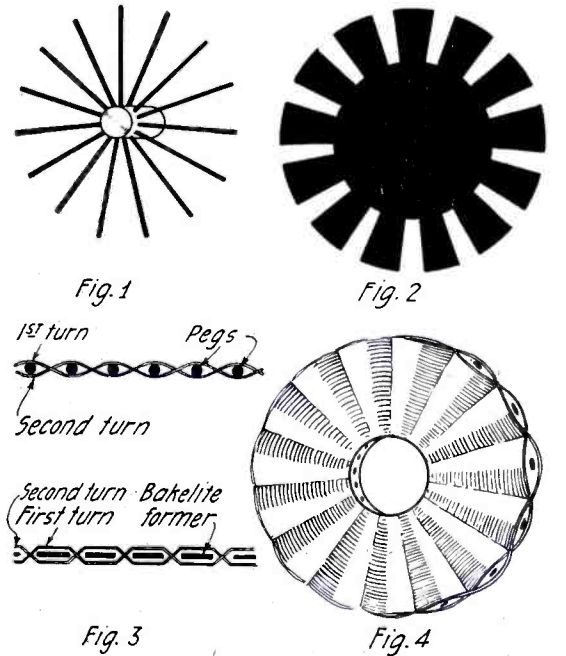

The Method of Winding the Basket-Woven Coils is Clearly Shown in This Sketch. Figs. 1 and 2 Are the Forms Used for Winding Basket and Spider Web Coils.

enables spark jamming to be entirely eliminated. Coils can be mounted in any fashion desired by the experimenter and forms an extremely compact receiving unit, giving a wider range and more exact tuning than any coils now on the market.

## Hunting the Trouble

By X. PERRY MENTER

THE radio set is heir to many ills, but fortunately the number of remedies is greater, and we will discuss in this article some of the simpler remedies, or what might be called "household remedies."

Most stations do not have any special trouble hunting devices such as are a part of the repairman's tool-kit, and so we have to work with the test lamp, the buzzer, or the voltmeter. These are sufficient, however, to locate almost any trouble which may develop in the ordinary radio set. Let us consider first the transmitter. It happens sometimes that upon attempting to start up the motor generator, it will not *mote*; something having gone wrong on the D.C. side of the motor generator set. We should first ascertain with the test lamp or voltmeter, if the power is on the line, by testing for voltage across the entrance switch. If it is not there, or is very low, we need look no further for the trouble, as it is necessary to keep the motor properly fed up on volts or it will withhold its horsepower. Next, test the fuses and see that all connections are tightly made; also see that one or both of the brushes have not lifted off the commutator, and that nothing holds the armature from starting; it should turn freely by hand. If everything is right thus far, see if you have voltage at the motor brushes and across the fields. If no voltage is found there, tests must be made back along the circuits toward the entrance switch. If there is no voltage at the brushes, the trouble is probably in the starter, the resistance wire has probably burned out or broken off. An inspection of the starter will show whether or not it is open, and if found open, the break must be closed. If the starter is found to be O.K., it must be one of the leads between the entrance

switch, starter, and armature. Which one may be determined by disconnecting from the motor and starter, and by testing one at a time, using a test lamp or voltmeter. In case the leads are intact, the field circuit should be looked over. If there is no voltage across the fields, go over the resistance and leads in the same manner as for the armature. In case the field is broken at a multiple contact antenna transfer switch, there may be a poor connection. If no trouble has been located up to this point, then the fault lies in the armature or fields of the machine, which can be ascertained by testing one at a time.

Disconnect the fields entirely, and with the test lamp or voltmeter find out if any of them are open or grounded; in case they do show open or grounded, disconnect one at a time and test until the right one is located. If they test clear, then the trouble must be in the armature, it is probably grounded or shorted. This, as a rule, is a job for the repair shop, but if it is desired to locate the grounded or short circuited coil or coils, it may be done as follows: Disconnect the coil leads from the commutator bars and test with the test lamp to the shaft from each coil; this will show the coil or coils which are grounded. It often happens that the commutator becomes grounded, either because of punctured insulation or because of lubricating oil working into the insulation and collecting copper or carbon dust which proves a ready path for a leakage of current and consequent carbonizing of the insulation. The commutator tested in the same manner as the coils will show the grounded bar or bars. Grounded coils are often the result of bends too sharply made where they leave the core slot, or of being hammered down too hard.

the sharp edges of the core cutting through the insulation. In well constructed armatures the slot insulation is extended well beyond the end of the slot, then slit and laid back against the face of the core.

A quick way of locating a short circuited coil is to read the voltage drop from bar to bar of the commutator with a low-reading voltmeter. The short circuited coil will have a smaller drop than the others. A resistance must be placed in circuit to keep the current flow down and the reading taken with a steady current flowing. If the line voltage fluctuates badly, it will result in misleading readings. In most cases these short circuits take place between commutator bars, and it is necessary to unsolder the coil leads to determine whether the short is in the coil or at the commutator. A short circuited coil will heat up badly after a short run also, and may be located by merely feeling around the armature with the hand.

Open coils announce their presence in no uncertain manner; violent sparking takes place with heating and blackening at the commutator bar connected to the open coil. Temporary repairs may be made by nicking and turning over with a cold chisel and hammer the two end edges of the adjacent bars until they touch and short out the bad oil, or a wire may be soldered across them. The running of the motor will not be affected much by the cutting out of a coil or even a number of coils, provided they are not bunched together. It is better to effect the necessary repairs as soon as possible, however, as the heating and speed of the armature will be increased, due to a higher current flow because of the reduced counter electromotive force of the arma-

(Continued on page 348)



# The Hulbert Transrectifier

A Transformer and Rectifier of A.C. to D.C. in One Simplified Apparatus

By H. H. SMITH

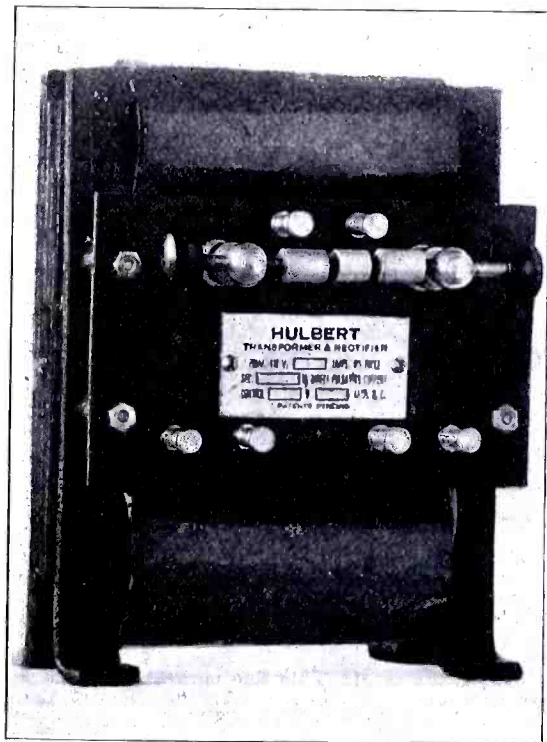

This New Transformer Rectifier Delivers Some H.T. D.C. When Supplied with A.C.

**D**URING the history of electricity, there has been a great deal discovered by research, study and practice. The forerunners of civilization regarded anything with a static charge of electricity as being magical. Following the discovery of the loadstone, it was noted that direction could be ascertained under conditions which would not permit, previous to the discovery. It was not until Faraday's time, however, that the relation between static electricity, electricity produced by chemical action and magnetism was discovered. The latter discovery was the beginning of what we may call an electrical revolution.

Shortly after Faraday's discovery, the principle of our modern dynamos and alternators was approached and a current similar to the current given out by a cell was sought. As soon as direct current potential could be developed effectively, direct current was used for light and power. Although direct current solved the problems of that time, it soon became known that direct current could not be transmitted a great distance economically.

This gave the minds of the electrical industry new problems to solve which resolved into the use of high voltage. But high potential direct current could not be generated economically. However, alternating current came into use and since then it has been possible to generate alternating current at a low potential and step it up to an economic potential for transmission. Although alternating current gave the minds of the electrical industry a new medium by which large quantities of power could be transmitted economically, it also gave them new problems to solve that can be eliminated by the use of high potential direct current.

A generating company in France has tried to eliminate the alternating current losses by generating a high potential direct current with a system of direct current generators connected in series. Such a system necessitated a large insulation problem of insulating the machines from each other, and is believed to be impracticable since no

other company has found it advisable to adopt such a system. The desire to produce a high potential direct current economically, however, has been the fanciful dream of many an electrical engineer.

With all the electrical conveniences we have to-day: the central stations, electric railways, the telephone, telegraph, automobile ignition and many other inventions and discoveries too numerous to mention, it remained for Mr. C. H. Hulbert, of Chicago, Ill., the inventor of many useful electrical devices, including the submarine detector, to discover a new simple method of transforming and rectifying any voltage and frequency alternating current to any desired high potential direct current. Mr. Hulbert was experimenting for an amplifier when he discovered that he was getting a high potential direct current from an apparatus supplied with alternating current.

The new device was then investigated further and found to be an apparatus by which alternating current could be transformed and rectified to a very high potential direct current most effectively. Although looking very much like a transformer, it differs somewhat, inasmuch as it is controlled by a small potential direct current and involves the use of a special arc. In an ordinary four-coil rectangular core type transformer, there are two active and two inactive cores as illustrated in Fig. 1, the heavy coils representing one winding and the light coils representing the other winding. The alternating current electromagnets corresponding to a simple transformer as shown in Fig. 1, during one complete cycle can be represented by Figs. 2 and 3, in which there are two reversals of magnetism for every cycle. Should there be a direct current electromagnet intercepted parallel and between the two outside magnets, it is possible to have two magnets of the same polarity for each half cycle, as illustrated in Figs. 4 and 5. With the aid of a specially constructed core, which the Figs. 4 and 5 represent, two primary coils connected in series or multiple, a direct current coil to control the central magnet, two secondary coils connected in series and in opposition, a three-point spark gap or condensers, the middle point of which is one side of the direct current supply and the middle tap of the secondary is the other, it is possible to get a very high potential direct current with the outside of the secondary coils connected to the outside electrodes.

The operation of the Hulbert Transrectifier is similar to that of a transformer. Upon impressing an alternating current potential on the primary and a direct current

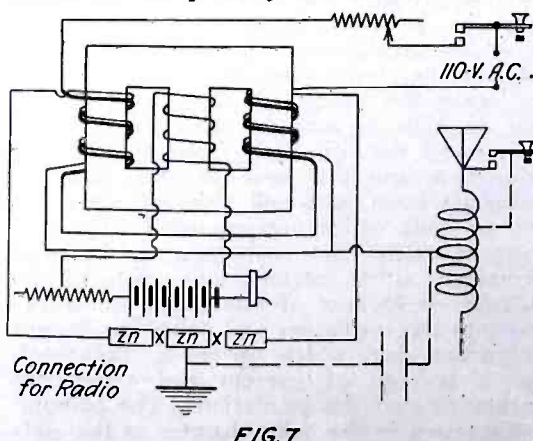
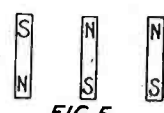
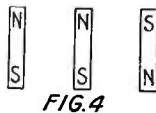
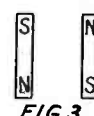
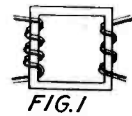
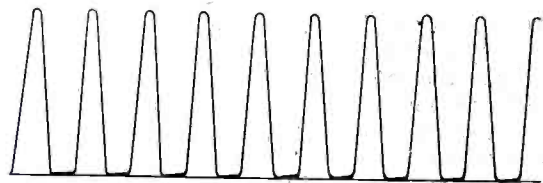

Diagram of Connections of the Transrectifier, the Broken Lines Showing the Connections to a Radio Circuit.



Oscillograph Curve  
FIG. 6



The Upper Sketches Show the Method of Winding, and the Successive Changes of Polarity of the Legs of the Core in the Transrectifier While in Operation. Fig. 6 Shows the Secondary Wave Form on a High Resistance Load.

potential on the direct current control coil, the secondary supplies power in the same proportion that the primary receives energy minus the losses of the apparatus. Putting one side of the gap into operation gives a certain output on the secondary and gives a pulsating direct current equal to one-half the pulsations of the alternating current source. Bringing in the other half of the secondary increases the output about 50 per cent.

The secondary wave form, as photographed at the Bureau of Standards, Washington, D. C., on a high resistance load is characteristic to that of Fig. 6. By using flat electrodes, the secondary wave form has a sine curve shape with oscillations within the wave itself. The oscillations within the wave itself are due to the arcs changing from one part of the electrodes to the other. By using two flat outside electrodes and a fine center electrode, the secondary wave form is a smooth pulsating direct current, the shape of the pulsations being similar to a half of a sine curve.

The applications of high potential direct current are unlimited in scope. A few of the immediate needs are for wireless telegraphy, especially for a selective method of sending, wireless telephony, smoke precipitation, X-ray work, chemical and physical research and many other applications of the industrial and scientific world.

For wireless telegraphy the connections are similar to those of the Poulsen arc. It is possible to vary the oscillating circuit by interrupting the primary of the transrectifier or varying the impedance in the oscillating circuit. The former method gives a more distinct sound and does not cause interference with other wave-lengths. By the Hulbert arc method of sending, the transrectifier does away with motor-generator sets, many forms of bulbs and other expensive sending apparatus. Any wave-length can be obtained whether low or high. There is no limit to the radio field of this apparatus, the questions of power and voltage simply being a matter of design.

For wireless telephony work, a transmitter placed in the direct current control circuit modulates the secondary direct current output in the same proportion as the sound waves are received in the transmit-

(Continued on page 356)



# The Vaughan Radio-Controlled Car

By S. R. WINTERS

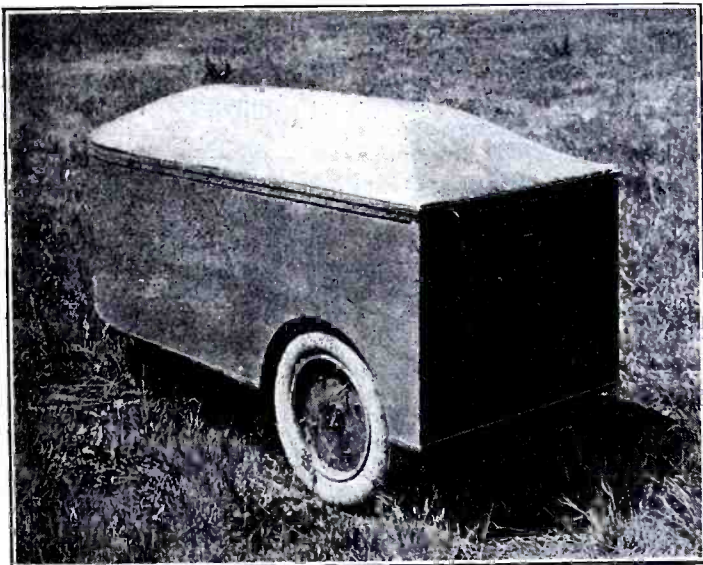

Here is the Three-Wheel Car Equipped With Rubber Tires, as a Regular Automobile; Note the Lead In in the Back of the Car.

AN article in the September issue of RADIO NEWS mentioned that traffic laws were disregarded, the flexible warnings of semaphores were ignored, and the traffic policemen of Dayton, Ohio, were utterly astonished when recently a miniature automobile made its way over the streets, with no person aboard. The machine was controlled and operated by wireless equipment, the guiding automobile remaining 100' to the rear of the manless car.

The radio-controlled motor vehicle is an invention of Captain R. E. Vaughan, of the engineering division of the Air Service, United States Army. Its functioning by wireless equipment is without the use of masts or aerials, as may be seen in the photograph of the car; a system of condenser antenna is used, which consists of

wire cloth fixed in the top and the bottom of the car.

The other view shows the inside of the car with its various organs of control and traction. In front of the car may be seen a compressed air bottle used to move the directing wheel through a system of pistons operated by an electric relay opening or closing the compressed air supply in the proper cylinder. The relay itself may be seen in the center of the wooden frame. On

the right is the receiver and amplifier, with, in front of it, two stages of power amplification, used to operate the relays of the various controls. On the left is the selector which has to decode each combination of dots and dashes corresponding with each control and make the necessary connections to the proper relay, three of them being visible on the left of the smaller storage battery.

On the right of the steering wheel relay is the horn which may be blown at command, as well as a whistle which is heard very far away. Near the end of the compressed air bottle on the left, may be seen the electric bell which is also operated by special control and adds to the two other instruments to produce an ultra-strong

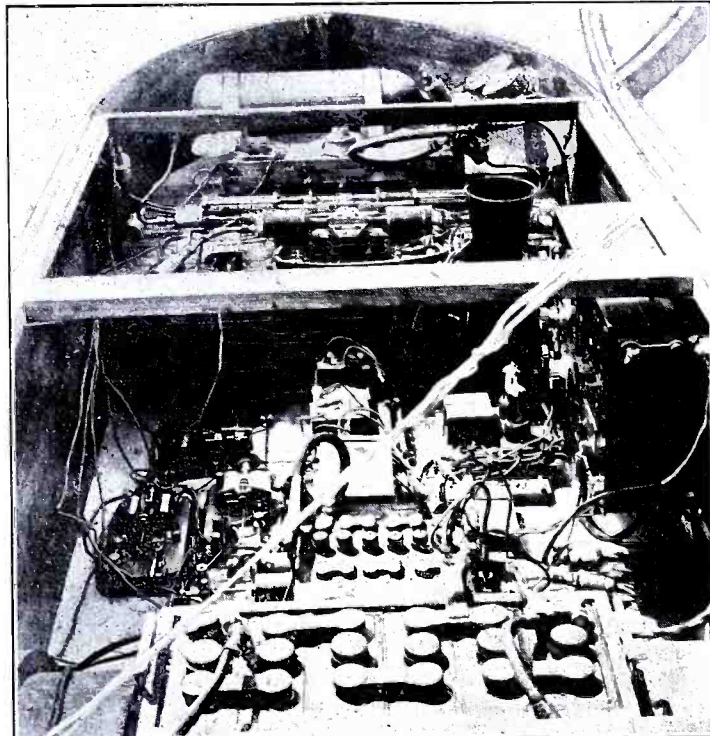

In This Photograph May be Seen All the Instruments Used to Control the Car. Note the Receiver and Amplifier on the Right.

warning noise.

The car may be stopped very quickly, thanks to its good air brakes acting on the rear wheel and operated also by compressed air.

Besides the possibility of using this driverless car for warfare purposes, another possible use—one of doubtful application in view of the farmer's distrust as to the practicability of the device—is that of guiding a tractor in plowing a field while the

(Continued on page 358)

## Radio Reception at Ketchikan, Alaska

By R. A. ANDERSON

AS we all know, signal strength, and the different stations heard, vary according to the type of aerial used, also according to type of apparatus and the location of the station, but it also seems to vary greatly according to the climatic or atmospheric conditions, either during the day or night, winter or summer. However, there is one place on the globe, at least, that dares to defy these general rules. Whether this is due to the apparatus used or whether it is something else, I am in no position to say, but I do know how reception is there.

Using a 225' aerial, single-wire, elevated about 30', and a bulb detector with a "Tresco" tuner, there are several stations which are heard ALWAYS with the same degree of signal strength. Of course, during the daytime, there is a very slight difference in strength, but the atmospheric conditions apparently have no control over their strength or the regularity of their reception. Take POZ, for instance, he can always be heard, but between five and ten P. M. he is always a little bit louder, yet he can be heard at any time of the day or night, if he is sending. When there is a great deal of interference from static or "atmospherics" as they are sometimes called, his audibility or comparative strength remains the same, although he is, at times,

not readable. The same is true of NPG, NSS, WII, WSO, NPA and NPM, which are: San Francisco, California; Annapolis, Maryland; New Brunswick, New Jersey; Marion, Massachusetts; Cordova, Alaska; and Honolulu or Pearl Harbor, Hawaiian Islands, all in the order their calls were given.

Of course that does not mean that POZ, Nauen, Germany, comes in as loud as Pearl Harbor, because it doesn't, but the conditions surrounding the reception of each are the same.

These stations are heard regularly at 7IT, which is situated on a hill, while boats moored in Ketchikan are sometimes unable to hear those stations. The same is true of the Naval station here, which was, for a long time, unable to hear our POZ at all. One night they would be able to hear some station, as POZ, and the next night he might be much louder, much weaker, or else not heard at all. So much for the arc stations.

The conditions surrounding the spark stations are different. The high powered sparks are heard a great deal, at 7IT, but are usually very weak and are only to be heard on the same tune as some arc. Thus it is readily seen that no calls can be heard, at least not with any degree of either regularity or reliability. However, many 600-

meter sparks are heard. Some, or rather the majority, of these are heard every evening, but, either because of atmospheric conditions, change of wave-length to more or less than 600, or else the non-communication of that or those stations, some are not heard every night. For instance, the two 600-meter stations at Honolulu have only been heard at 7IT three or four times. The same is true of KPH, which is the 2 k.w. San Francisco Beach station. During the past four months it has been heard no more than a half-dozen times. Of course any of these stations may have been heard every night, but not read because of the 600-meter QRM, although I doubt this. Of course no rule can be given for the general reception of ship stations, because they are bound to be here one night and gone the next, and they are also to be heard louder one night than they were the night before, or than they are to be the next night.

One thing can, however, be said about ships, they seem to fade a good deal, and the writer always took it for granted that they did fade until one night something happened that seemed, at the time, rather amusing.

One of the Japanese "Marús" was working, or rather trying to work VAE, Estevan, Canada. Each time the Japanese ves-

(Continued on page 358)



# Radio Digest

## THE DISTRIBUTED CAPACITY OF INDUCTANCE COILS.

By G. Breit.

This paper is intended to call the attention of physicists and mathematicians to some interesting aspects of the subject of distributed capacity of coils. The subject is of practical importance because inductance coils are used extensively in radio communication and because the distributed capacity, taken in connection with the value of inductance, determines the range of wave-lengths within which the inductance coil can be used to advantage. Furthermore, there is considerable mathematical interest connected with the calculation of the effective capacity caused by the capacity distributed along the wire of the coil.

The subject has been largely neglected by mathematical physicists. Lentz and Drude seem to be the only ones who have made a study of it. However, there are errors in Drude's mathematics, while Lentz's results are not adapted to numerical calculation and involve too many assumptions to be used generally. For example, his treatment applies only to wires having circular section and further it combines the assumption of negligible curvature of a single turn with that of an infinitely long coil. This combination of assumptions may be justified for treatment of skin effect. Its applicability to capacity calculation is questionable.

In this paper an outline of the general method of calculating the effective capacity is given and then illustrated by working out some of the formulae.

(Abstracted from the *Physical Review*)

## BERLIN-LONDON WIRELESS SERVICE.

On January 26th a duplex wireless service was opened between London and Berlin for a period of three hours daily, from 4 p. m. till 7 p. m.

The Stonehaven Wireless Station (GSW), being the only medium-power station available, is used for the transmitting station on the British side, while Königswusterhausen (LP) Wireless Station is used on the German side, the respective wave-lengths being 4,600 and 5,250 meters.

The transmitter at Stonehaven consists of an Admiralty 25-k.w. arc, which is operated from London by means of the telegraph land line. The receiving station in England is situated in a special room in the G.P.O. West, together with the land line apparatus and Wheatstone transmitter for operating the wireless key on the Stonehaven arc transmitter.

The signals from Berlin are recorded on an ordinary Wheatstone receiver, which is introduced in the local circuit of a special form of sensitive "bow-contact" relay actuated directly by the wireless signals. Trials are now being made of reception on the Creed apparatus.

Difficulties were at first experienced on account of the slight variations of wave-length emitted by Berlin and Stonehaven, but the constancy of the waves of the two transmitting stations has been improved.

Atmospherics on these higher wave-lengths are more violent than those experienced on the shorter waves below 2,000 meters, but little interference is experienced on this account owing to the use of highly selective receiving devices. By these devices the high-power station at Moscow, which uses a spark transmitter on approximately the same wave-length, is effectively eliminated from the tape records.

Abstracted from *The Post Office Electrical Engineers' Journal*.

## SEATTLE'S RADIOPHONE.

By Howard S. Pyle.

Of considerable interest to Northwest amateurs is the installation of a five-watt radiophone by the *Seattle Post-Intelligencer*, a popular morning paper. The installation was made, and is operated under the supervision of the Northern Radio Co., of Seattle.

A four-wire antenna atop the newspaper's building in the downtown section acts as a radiator. A counterpoise ground is used, with which better results are obtained than with the steam radiator ground formerly in use.

The service offered by this phone is unique, in that a news bulletin is read daily, from 9:00 to 9:30 p. m., containing all the late world news. This service is also interspersed with concert music, furnished by means of a phonograph, and it is planned later to entertain with actual vocal and instrumental selections.

To date, the signals have been reported as being very well received at Lacey, Washn., a distance of seventy miles, which is the voice record so far. To the westward, not much distance is obtained, due to a large steel frame building rising several stories above the antenna and but a few feet away, which seems to absorb considerable of the

### Radio Articles in October Number of Science and Invention

Testing of Insulators and Control of Power Systems by Radio—the work of the Westinghouse experts. Illustrated and described by H. Winfield Secor.

A Practical Wireless Telephone Set—in which is described an excellent transmitter assembled from stock parts which can be purchased in the open market. This set was actually built and tested. By Arthur H. Lynch.

How to Build a  $\frac{1}{8}$  H.P., A.C. Motor—excellent for operating rotary spark gaps and other radio apparatus from 110 volt, 60 cycle A.C. circuits. By H. Johnstone.

Question and Answer Box.

radiated wave. Reports on the signal strength and data on the received signals, will be appreciated by the Radio Editor of the *Post-Intelligencer*, Seattle, Washn.

## SPRINGFIELD, O. TO HAVE MUNICIPAL RADIO STATION.

Appropriation of funds for the installation of a municipal radio station in Springfield, Ohio, will be included in the 1923 budget of the city, according to an announcement made by Edgar E. Parsons, city manager. The proposed station, said Mr. Parsons, will be established in the city building and will be mainly devoted to activities of the police department.

The announcement followed the visit of a delegation of local amateurs who had urged the city manager to make use of the amateur operators in the vicinity in broadcasting police news. It was the result of this suggestion that led to the proposal for the establishment of a municipal station for the city.

The proposed station, under tentative plans, would cost about \$1,000. The city building is an ideal location for the aerials, there being two high towers at each end of the building, about four hundred feet apart, upon which the aerials could be strung.

At present, the city has a voluntary motor police corps auxiliary, composed of leading motorists of the city. It has been suggested that the municipal station could get in touch with these in an emergency, and continue to direct them, regardless of where the cars happened to be, if the corps officers' cars were equipped with radio receiving apparatus.

## \$175 PRIZE CONTEST.

The Amrad Double Prize Contest has been extended to December 31, 1921, according to announcement by the American Radio & Research Corporation.

Nearly \$175 worth of new apparatus is offered as prizes in the two contests. The reason given for extending the closing date is to enable all the radio men in the country to enter instead of the comparatively limited number who were fortunate enough to attend the first National Radio Show at Chicago.

Three prizes are offered in the first contest for the best name selected for the new basket-weave, wavy wound, Amrad Variometer. Three prizes are also offered for the best name given for the new mahogany finished Amrad Regenerative Tuners, and Detector Two—Stage Amplifiers.

Contestants are requested to see the new apparatus at their nearest dealer's. They may also obtain descriptive literature regarding the new equipment from their dealer or request bulletins O and L from the company direct.

Contest blanks may be obtained upon application to the Contest Department, c/o the company, at Medford Hillside.

Announcement of the prize winners will be made in the radio publications as soon after the close of the contest as possible.

All radio men in the country, except Amrad employees, are eligible to enter.

For further details write the American Radio Research Corporation, Medford Hillside, Mass.

## "E M F ELECTRICAL YEAR BOOK."

First annual edition, 1921. Chicago: Electrical Trade Publishing Co. Cloth, about 1,000 pp. (9 x 12 in.).

The first edition of what its publishers aim to make a very useful annual reference book of current information for and of the electrical industry has made its appearance. It comprises three leading features: Compilations of facts and figures about each branch of the industry, definitions of electrical and allied terms, and a classification of products made and used by the industry with listings of their producers. All topics are entered alphabetically, the entire text being arranged as in an encyclopedia or dictionary so that it is very easy to find any item desired.

In the products and manufacturers' directory feature there are included over 2,900 classifications and subclassifications of electrical and related products, each of which is first descriptively defined and followed by the list of its American and Canadian manufacturers. Each leading class of apparatus (such as generators, motors, batteries, switches) is preceded by a general article on principles, types, production, etc. The products include not only all distinctively electrical machinery, instruments, appliances and supplies, but all other equipment needed for power plants, lines, electric railway tracks and cars, electrical manufacturing, contracting or merchandising, in short everything, except service, that is produced by or bought by any branch of the electrical industry. This constitutes nearly six times as complete a buyers' electrical guide as any heretofore prepared.

(Continued on page 352)



# Who's Who in Radio

E. F. W. ALEXANDERSON, E. E., R. E.

No. 9

**B**ORN in Upsala, Sweden, Jan. 25, 1878, Mr. Ernst Fredrick Werner Alexanderson was educated at the high school and University of Lund, Sweden, and at the Royal Institute of Technology in Stockholm, completing a Post Graduate Course at Berlin.

He entered the service of the C. and O. Electric Co. in 1901, and joined the General Electric Co. in 1902. He occupies the post of consulting engineer to the latter concern and is also chief engineer of the Radio Corporation of America.

After years of research and constant work, he developed a type of high frequency alternator suitable for Radio work, which is known today under his name. To be used in conjunction with this high frequency alternator for Radio telephone transmission, he designed the magnetic amplifier, which is used to modulate the antenna current.

In 1915, Mr. Alexanderson came in contact with Sr. Marconi; during a visit to the Schenectady works, and an arrangement was made to install the large Radio frequency alternator and magnetic amplifier at the New Brunswick Station, owned by the Marconi Company.

This sending set has given full satisfaction, having a high degree of efficiency, and has been adopted by the Marconi Co. and the Radio Corporation of America to be used as a regular transmitter in all the big stations of these companies.



Mr. E. F. W. Alexanderson, Inventor of a High Frequency Alternator and of the Magnetic Amplifier, as Well as Several Other Radio Devices.

Besides these inventions, Mr. Alexanderson holds numerous patents on various Radio apparatus, and is at the present time developing some new inventions in the General Electrical Works, at Schenectady.

Among several papers and articles written by him may be mentioned "An Alternator for 100,000 Cycles," which was presented to the American Institute of Electrical Engineers and in which was described the alternator already mentioned. The announcement of the successful completion of such a machine caused considerable sensation because the frequency was ten times as high as had previously been considered possible for practical purposes with a dynamo-electric machine.

While developing the magnetic modulator he delivered at the American Institute of Electrical Engineers a very interesting paper entitled "Magnetic Properties of Iron at Frequencies Up to 200,000 Cycles per Second." This paper has been extensively quoted in the scientific literature in every country and is considered unique along this line.

Among others may be mentioned "Dielectric Hysteresis at Radio Frequencies," "Magnetic Amplifier for Radio Telephony," "Simultaneous Sending and Receiving," "Trans-Oceanic Radio Communication."

Mr. Alexanderson is a member of the American Institute of Electrical Engineers and of the Institute of Radio Engineers.

## Determining Condenser Capacity

By F. M. EDWARDS

**I**N high frequency circuits encountered in radio telegraph, continuous and discontinuous wave generators, the condenser, or concentrated capacity, is of vital importance.

Calculation of capacity, or the design of a condenser of specified capacity, may be quickly and accurately determined from the accompanying table. The figures shown are the values in microfarads of unit condensers having metallic coatings one inch square on both sides of a dielectric substance. If the capacity, in microfarads, of a condenser is to be found, the number of square inches of metallic coating on one side of each insulating plate may be multiplied by the figure opposite the thickness and under the class of dielectric used. Or if it is desired to construct a condenser of a certain capacity, divide the figure found opposite and under the thickness and class of dielectric to be used, into the desired capacity, and the re-

sult obtained will be the number of square inches of foil or other metal coating necessary for one side of each separating sheet. (The value of "window glass" sometimes used by the experimenter is approximately equal to common glass, while photograph plates may be calculated by using very light flint glass. The very dense flint glass applies to the better grades of Bohemian glass, etc.)

For example, if it were desired to construct a condenser by means of the figures in the accompanying Table, to have .01 mfd. capacity, and using window glass  $\frac{1}{8}$ " thick; it will be noted from the Table that the value of the unit condenser of  $\frac{1}{8}$ " common glass is .000010095019 mfd., which, divided by 1,000 becomes .010095019, which is .01 mfd., within approximately nine-tenths of one per cent. This means that 1,000 square inches of metal conductor must be used on one side of dielectric sheets. Such a con-

denser may be built up with 25 glass sheets coated on both sides with foil 5" x 8".

As the capacity of a condenser is directly proportional to the area of its conductors, and inversely proportional to the thickness of its dielectric, it is readily seen that the capacity may be doubled by either reducing the thickness of the dielectric one-half, or by doubling the number of square inches of the metal conductors. To find the capacity of a condenser with a dielectric of a lesser thickness than is shown in the Table, divide that thickness into a thickness shown in the Table, and multiply the capacity by the figure obtained; or for a thickness greater than shown, divide some thickness in the Table into the thickness to be used, and divide the capacity by the figure obtained by the division.

The capacity of a condenser may be directly calculated by means of the following equation:

$$C = \frac{2248 K A}{T 10^{10}} \text{ mfd.}$$

where: K = Constant of dielectric (1 to 10 for most substances).

A = Area of opposed surfaces of conductors in square inches.

T = Thickness of dielectric.

Where several opposed conductors are separated by dielectric sheets the equation becomes:

$$C = \frac{2248 K A (N - 1)}{T 10^{10}} \text{ mfd.}$$

where: N = Number of opposed conductors.

The action of a condenser is not unlike a  
(Continued on page 326)

CONDENSER CAPACITIES PER SQUARE INCH					
INCH THICK	MICA		FLINT GLASS		COMMON GLASS
	From	To	Very Light	Very Dense	
1-16	.0000287744	.0000575488	.000047261952	.00005323264	.000030285056
3-32	.0000101820	.0000383659	.000031507968	.00003548843	.000020190037
1-8	.0000148872	.0000287744	.000023630976	.00002661632	.000015142528
3-16	.0000095915	.0000191829	.000015753984	.00001774421	.000010095019
1-4	.0000071936	.0000143872	.000011815488	.00001330816	.000007571264
3-8	.0000047957	.0000095915	.000007876992	.00000887211	.000005047509
1-2	.000035968	.000071936	.00005907744	.0000665408	.00003785632

With this table it is easy to find the necessary surface of armature required for a certain capacity.



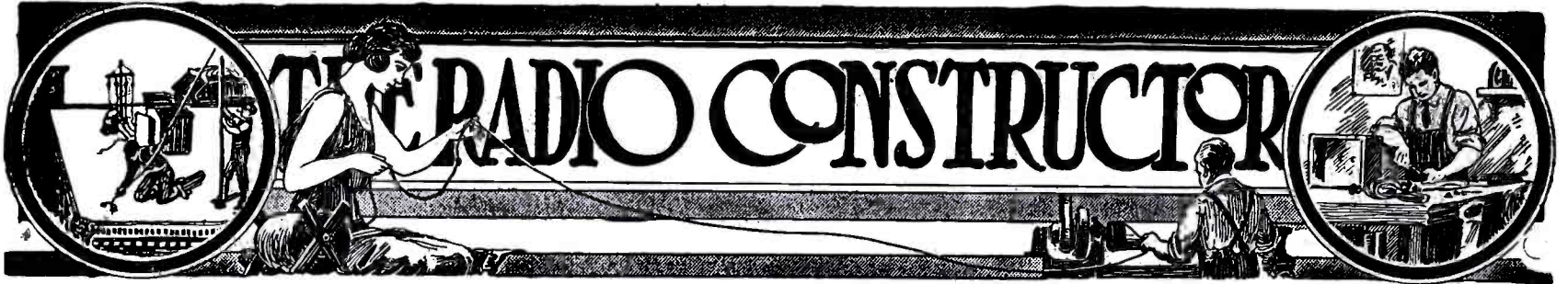

# Relay Keys for Transmitters up to 1 K. W.

By S. SOLOMON

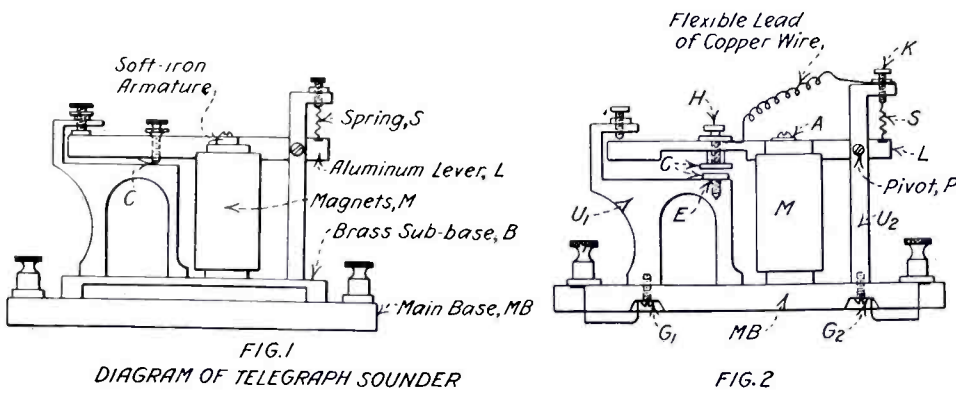

Fig. 1 shows a standard telegraph sounder and Fig. 2 shows same modified, to be used as a relay key.

THE use of a relay in spark transmitters becomes necessary when the current to be interrupted is so heavy that the construction of a hand key which will be heavy enough to carry this current and make and break the current promptly without lag by hand, becomes too difficult, and also when it is desired to transmit at high speeds by means of small keys which cannot handle the entire current. The requirements of a good relay key may, therefore, be summed up as follows:

1. Contacts must be heavy enough to handle the entire current without undue heating.
2. Positive and clean contact must be made over the entire surface of the contacts, or the contacts will wear away on one side and leave the surfaces irregular.
3. The relay must be prompt and snappy in its action and should follow the action of the main key without lag.

These requirements cover the design of a good relay quite thoroughly, but it may be noted that for relay keys of high power, say 5 K.W. and over, the current to be broken is so large that excessive heating occurs and it becomes necessary to employ

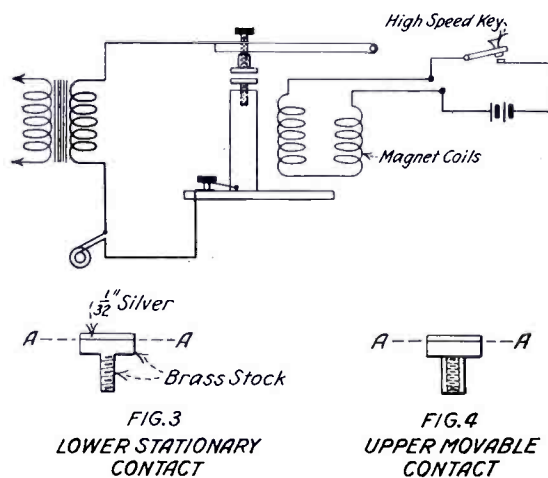

FIG. 3 LOWER STATIONARY CONTACT

FIG. 4 UPPER MOVABLE CONTACT



FIG. 6 DETAIL, SHOWING ALUMINUM LEVER CUT OUT, WITH CONTACT SET IN

The Upper Diagram Shows the Connections of the Key in the Transmitter Circuit. Figs. 3, 4 and 6 Are the Details of the Contact Mounting.

cooling devices, such as cooling fins, or in some cases even a blower. However, on sets up to 1 K.W. this condition does not arise, even when the key is carrying 100 per cent. overload.

The best type of relay for the amateur is, of course, the electromagnetic, but to design and construct a completely new one would involve considerable expense and trouble. While some amateurs have the facilities for the construction of such apparatus, the general rule is that the majority have not. It is for this majority of amateurs that this idea is offered herewith.

The idea underlying the present design of a relay key is the conversion of an ordinary landline telegraph sounder or relay into a relay transmitting key. The expense and construction involved in this conversion is a minimum. It involves the purchase of a sounder or Morse relay (and many amateurs have these items anyway), and a few minor changes, as will be seen from the following description. The use of a telegraph sounder or relay does away with the designing and building of the necessary electromagnet, which in itself is a very difficult task, since the sounder magnets can be employed without any changes whatever. These sounder magnets are designed most efficiently and no changes will be required. The only construction and changes necessary are: Construction of the relay key contacts, slight change in the pivoted aluminum or brass lever or the sounder, or slight change in one of the brass uprights on the sounder.

In Fig. 1 is shown a conventional view of a standard telegraph sounder, and Fig. 2 shows the sounder converted into a transmitting relay key. When the magnets, M, of the sounder, are excited by current, due to the vibroplex or high speed hand  
(Continued on page 342)

## Construction of a C. W. Power Transformer

By R. C. KANE

A NUMBER of articles, dealing with the construction and occasionally with the design of transformers for specific purposes, have appeared in various magazines, but little idea has been given of the general method of design for other than the specific case in hand. It seems desirable to make available to the amateur such of the principles and experience data as will enable him to design and build transformers suited to any of his various purposes. These principles are so simple that only arithmetic is needed in the design.

A transformer generally consists of one or more coils of insulated wire wound about a core through which, along the axis of the coil, there is a constantly changing flow of magnetism or magnetic flux. This core is generally of iron, but may be

of air, as in the case of the familiar loose coupler.

The potential developed in a coil wound about a core is expressed by the formula

$$V \text{ (volts)} = \frac{4.44fn\Phi}{100,000,000}$$

In this equation V is in volts, f is the frequency of the magnetic change in cycles per second, n is the number of turns in the coil, and  $\Phi$  is the maximum magnetic flux through the core.

Now in the design it is necessary to know what voltage the transformer is to operate on and what voltage it is to deliver. Be it known at this point that the induced voltage in the supply or primary winding is practically equal to and opposed to the supply voltage, so we may  
(Continued on page 360)

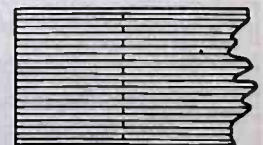
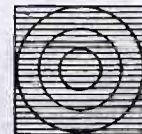

The Upper Sketches Show the Path of the Eddy Currents in a Plain Iron Core and How They Are Suppressed When Laminations Are Used. The Lower Ones Give the Method of Interleaving the Sheets Composing the Core.



# Overcoming the Gap Problem

By VINCENT TASSI

ONE of the great stumbling blocks in the way of the "ham" trying to advance his station from the spark coil to the "DX" class is the spark gap. A fellow usually manages to get a transformer and a condenser of at least fair efficiency and at a reasonable price, but most gaps that are liable to find their way into a low-priced set are far from being efficient and do not stand much chance of doing anything outside of causing lots of local QRM.

I will try to tell of two ways of getting around the gap problem for the benefit of those who can't afford to buy a good rotary. One way to overcome the difficulty is to make a good rotary. The chief reason why homemade gaps are not desirable is because it seems a problem to make a gap possessing a clean knife-edge break. Consequently the homemade style is usually a gap having the old round studs and a bad "drag" to the spark giving poor quenching and a poor note. The disc here described can be constructed at a trifling cost and can be made by one who is not so handy with tools. (I made one myself!) It has the much desired knife-edge break, has wide sparking surfaces, giving good cooling and quenching qualities. The total cost of the disc in my case amounted to \$2.

The main idea embodied in this disc, shown in Fig. 1, is the construction of the studs. They are cut from aluminum sheet  $\frac{1}{8}$ " to  $\frac{3}{32}$ " thick. First, cut out strips (number to be determined by number of studs desired on disc)  $1" \times 1\frac{1}{4}"$ . A quarter of an inch from one end of each, drill a hole to take an 8/32 or 10/32 machine screw. Then bend each strip at right angles  $\frac{1}{2}"$  from same end as hole was drilled (see Fig. 2).

If the gap is to be of the "spark through" type, which is the more efficient, mount the electrodes as shown in Fig. 3. If it is to be of the usual type, a strip of metal must be mounted around the disc to connect the

studs as in Fig. 4. In both cases the studs must be radially mounted at exactly equal intervals around the edge of the disc. After all studs are firmly mounted, they should be filed down to exactly the same length so that they can pass extremely close to the stationary electrodes. The disc, which is of bakelite  $\frac{1}{4}"$  to  $\frac{3}{8}"$  thick, should be as large as power of the motor will permit. Mine was 10" in diameter and was used with a  $\frac{1}{8}$  h.p. motor. The number of studs will, of course, depend upon the speed of the motor and the tone desired. No details of the stationary electrodes are given, as these can best be constructed by the individual to suit his own mounting conditions.

So much for the rotary. Now for a few words on the other way to beat the high cost of gaps. That is by means of the old, much abused fixed gap. The straight gap may be called inefficient and denounced as a QRM factory, but properly adjusted, it can be made to work wonders in the way of sharp tuning, smooth operation, pleasant tone, and real "DX." The reason there is so much prejudice against the plain gap is because it is so often the beginner's way of making all the noise he can. He gets a transformer of any old voltage, a condenser, the capacity of which he doesn't know and isn't worried about, a direct coupled helix, and the demon "plain gap." The tuning and gap adjustment are set at the point where the aerial ammeter reads highest. This does not happen to be the point of maximum range or sharpest tuning, but so long as it is the one that blinks the lights most, blows most fuses, gets most of the "big fellows" peeved at his racket, and cuts off most of a general fuss, he is satisfied. But the high ammeter reading only means that he is spreading his energy all over the wave-length scale, causing lots of QRM, and getting nowhere. The only way to get the energy and punch out of a plain gap is to adjust it so that you get one snappy, quickly quenched out spark for every alter-

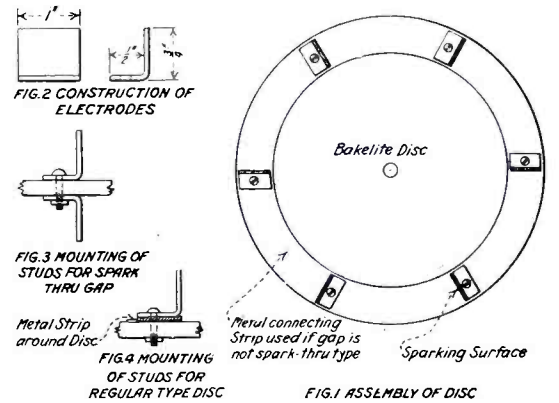

Constructional Details of an Efficient Rotary Gap That You Can Build.

nation of the line voltage, that is, to make your spark synchronous. When you obtain this condition, you have the spark that comes through with a snap and covers distance even though it pulls down the ammeter reading considerably. All that are necessary to get a set working this way are a few careful adjustments of the gap length and power input. In a set operated in this way, a high voltage transformer is more desirable as it permits the use of higher power, but low voltage need be no drawback. I used  $\frac{1}{4}$  k.w. 8,000-volt transformer, with very good results. The condenser must be as large as the 200-meter wave will permit. The gap used should have slightly rounded sparking surfaces. A variable resistance up to about 100 ohms is placed in series with the primary for the purpose of adjusting the supply voltage. This resistance may be of the slide-wire type or may be a water rheostat. If the resistance is varied, along with the gap length, a point will be found where a perfect 60-cycle spark is obtained (assuming 60  $\sim$  supply). The resistance should then be decreased and the gap lengthened until you reach the point  
(Continued on page 355)

## A Good Kick-Back Preventer

By A. LELAND MYERS

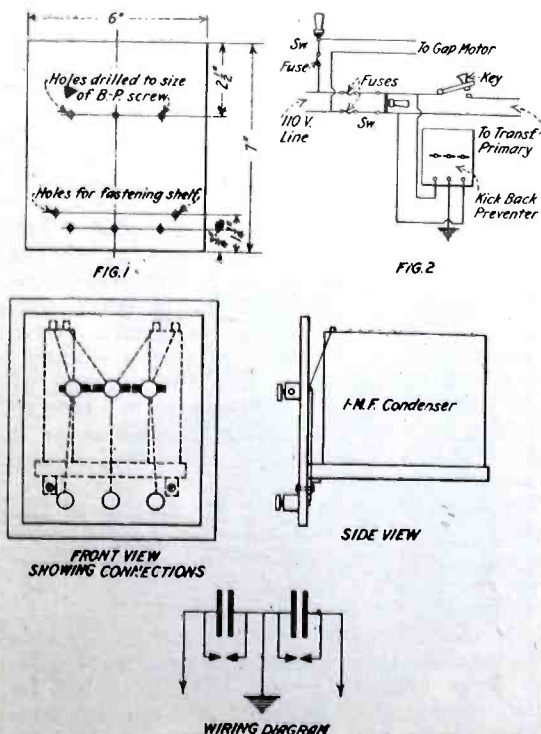

Here is a Much Needed Instrument for Spark Transmitters. You May Build One Yourself by Following the Directions Herewith Given.

A KICK-BACK preventer is a device that is little heard about, and yet it is quite a necessary piece of apparatus, which an amateur with a spark transmitter can hardly get along without. If a good one is made it will often save its cost in a short time, and also one can feel safe as far as the transformer surges are concerned, or kick-backs, which often cause much destruction. A surge may easily blow out a gap-motor, or any piece of apparatus in the same line with the transformer.

A kick-back preventer is not what its name implies; it does not prevent the surges, but takes care of them when they come. A good one may be made from odds and ends to be found in the average amateur's work-shop, or the materials may be bought from an electrical supply house. The list of materials needed are as follows:

- Two 1 mf. paper telephone condensers.
  - Six fair-sized binding posts.
  - Three short pieces of round brass rod.
  - One bakelite or formica panel (about 6" x 7" x  $\frac{1}{4}"$ ) for mounting the various parts.
- The panel should be considered first, and is laid out as in Fig. 1. The holes should be drilled to the size of the machine screws in the binding posts. The brass rods should be of the size to fit into the hole for the wire in the binding posts, and one of them should be longer than either of the other

two, the longer one should be  $1\frac{1}{2}"$ , and the other two  $1\frac{1}{4}"$  each. They should then be placed into the holes in the binding posts, and the posts put onto the upper holes in the panel. The post having the longest brass rod should be in the center, and the rod project equal distances on both sides.

The condensers should then be mounted on the back of the panel by a shelf fastened to it by small brackets, and the lower binding posts placed thereon. After this is done, the instrument should be wired as shown in the wiring diagram.

The two spark gaps—for that is the purpose of the three binding posts with brass rods—should be set as close as possible without touching. The lower center post should be connected to the ground and the other two to the transformer line.

The complete device may be mounted in a cabinet if desired. The connections for it in the primary circuit are shown in Fig. 2.

We receive quite a number of inquiries from readers asking how to stop the light blinking in their houses when they operate their spark sets. Here is the answer: make a kickback preventer and protect the lines.

We would say the same about several other subjects, before writing for information about how to make a certain instrument. Look in your back copies first.—Editor.



# A Universal Panel Type Receiving Set

By T. H. WILLERS

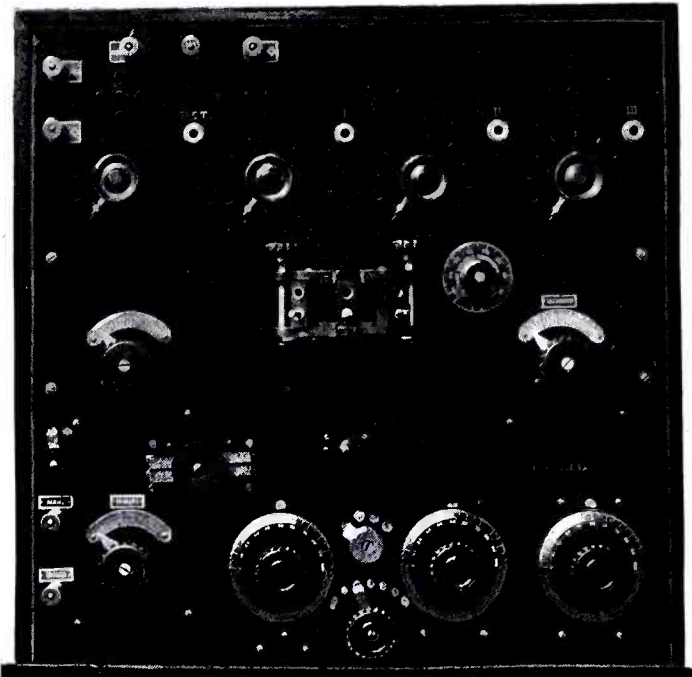

Here is a Well Designed Receiver and Amplifier for the Reception of Any Wave-Length.

side of the series parallel switch.

In the construction of this receiver with detector and three-stage amplifier, standard parts are used throughout and the photographs show how they are mounted either on the front, or behind the panel. Looking at the front view, from top to bottom, may be seen in the upper left-hand corner the binding posts for the "A" and "B" battery connections, then the four jacks and rheostats controlling the detector and three steps. In the center is the honeycomb mounting with, on the right, a Connecticut condenser used as a vernier in

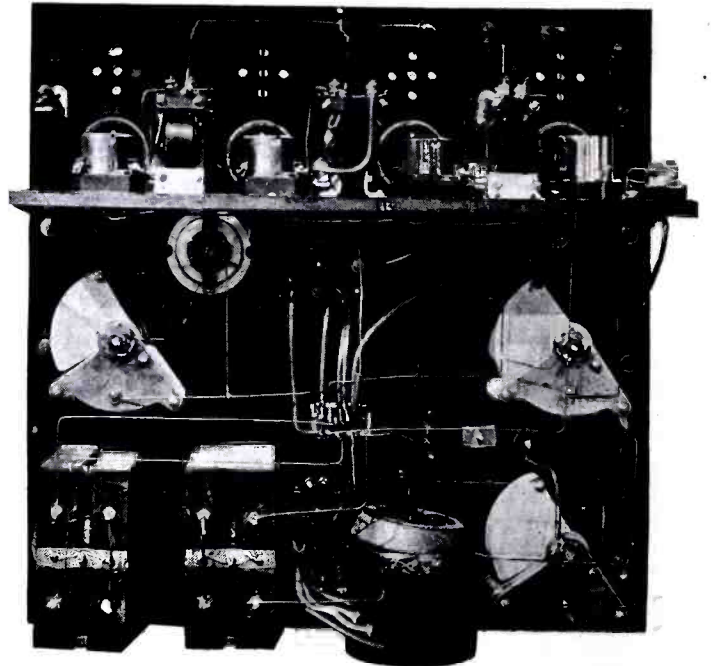

This Photograph Shows Every Instrument Used in the Construction of the Apparatus. Note the Wiring.

HAVING to save space and wanting to receive short and long waves as well, with a detector and three-stage amplifier, I built the complete set in one unit, shown in the photographs. For long-wave reception, honeycomb coils are used and for short waves, a standard regenerative set composed of a vario-coupler and two variometers is mounted inside of the cabinet.

To change from long to short waves, a 4-PDT Federal switch is used and mounted in the center of the panel just under the honeycomb mounting. In order to use the antenna condenser with both sets, a special connection from the primaries is made on one

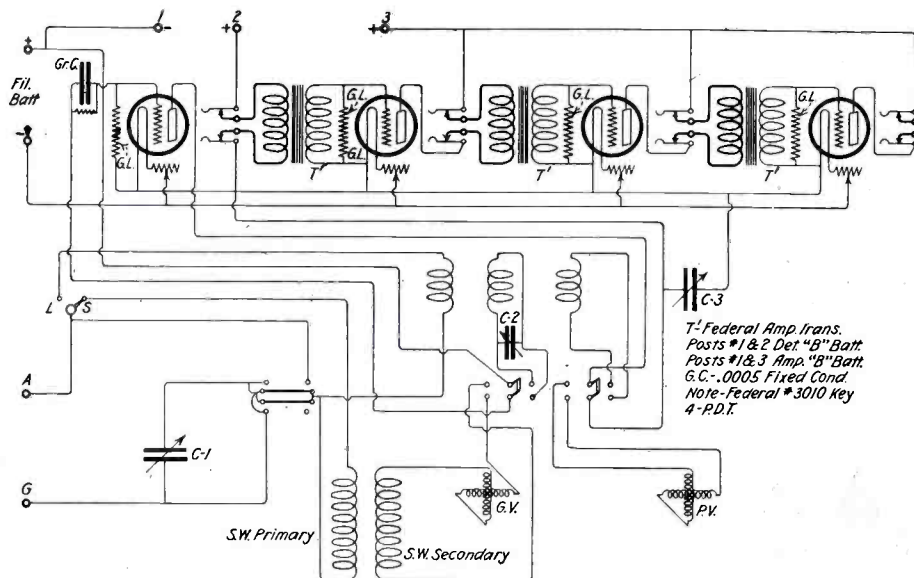

Complete Wiring Diagram of a Combination Long and Short-Wave Receiver With Detector and Three-Stage Amplifier.

the secondary.

This condenser is mounted directly on the panel, and has no other case. When mounting this condenser, it was noticed that every time the dial was turned to the left, decreasing the capacity beyond a certain point, the movable plate fell out of its guide. To overcome this, a short piece, about 1/4", of No. 18 copper wire was soldered on the guide studs, forming a lock against which the movable plate guide will strike when unscrewed.

On the left is the secondary condenser and on the right, the phone condenser. Below is the long-short-wave switch, the series parallel switch for the primary (Continued on page 357)

## A New Type of Variometer

By HENRY OBERG

THE chief reason most amateurs give for not constructing a short-wave regenerative receiver is that they do not want to construct a couple of variometers. I am in this class of amateurs and therefore have designed and constructed a variometer which is very easy to make and yet very efficient.

The variometer which I have constructed is wound on two tubes, one fitting tightly inside of the other. (About one-sixteenth of an inch clearance.) Fig. 1 represents a side view of the variometer complete. The dotted lines show the position of the inner winding when the two windings cross each other.

The winding is about the most difficult part of this variometer. As can be seen in Fig. 1, the wire is wound in an elliptical form. In order to do this, cardboard guides must be pasted on the tubes. The general layout of these guides can be seen in Fig. 2. No dimensions are given, as they will vary

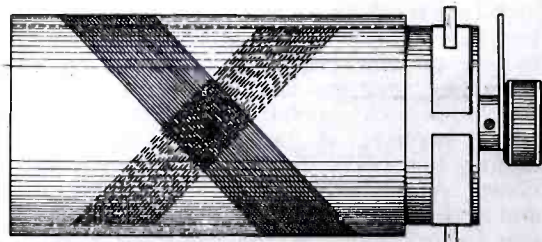

Fig. 1

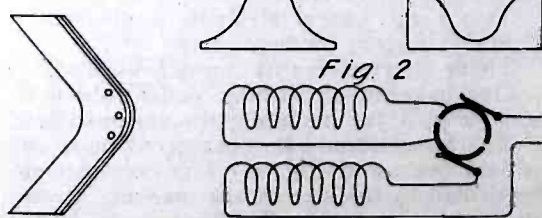

Fig. 3

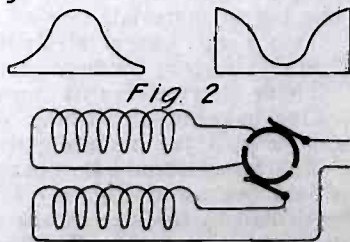

Fig. 4

This Variometer of New Design Has a 360° Adjustment and Makes Tuning Easier.

according to the size of tubes used. The writer has given no dimensions at all, as most experimenters wish to use their own dimensions. It will be found, however, that if the tubes are of small diameters, better results will be obtained. As some difficulties will be encountered in the winding of the coils, it will be necessary to use pins to hold the wire in place while winding, as it will have a tendency to slip down on one end; the pins should be moved at every turn. The dots in Fig. 3 show the placing of the pins. About 3/4" should be covered with wire on the outside tube and about 7/8" on the inside tube. No. 24 S.C.C. wire is recommended for the winding.

In order to obtain reverse current on this variometer commutator, segments and brushes have been provided. There should be two commutator segments and two brushes. The brushes and segments can be made from any sheet metal such as copper or brass and may be of any width, 1/4" or more. The (Continued on page 357)



# C. W. for the Amateur

By JAMES MILLEN

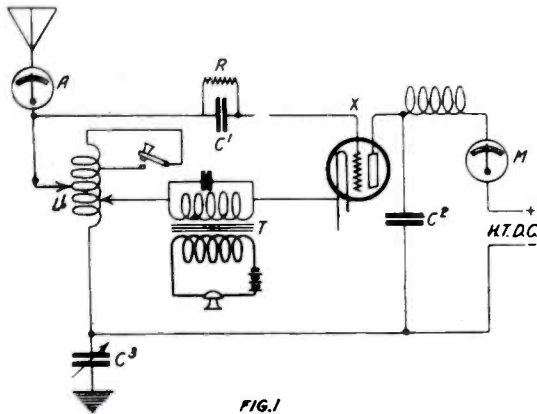
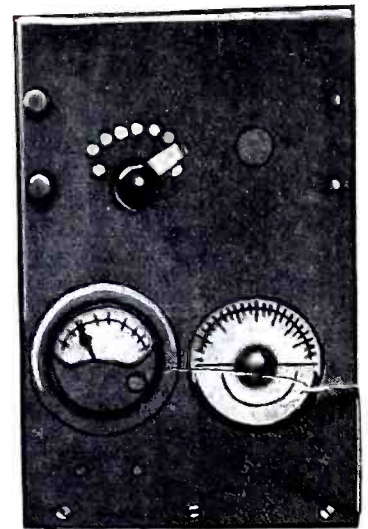
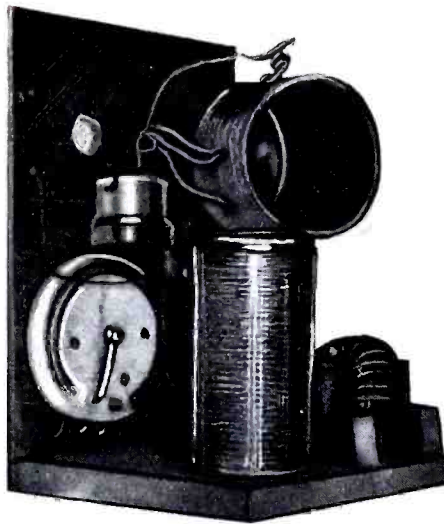

FIG. 1

Here is a good 5-watt phone and C.W. set. The two photographs on the right show the front and back views of the panel and on the left is the diagram of connections.



**W**HEN all the amateurs get C.W. sets and junk their spark equipment, QRM will no longer be what it is at present. C.W. also has many other merits, including the fact that it is not as expensive as a spark set, it is silent in operation, it does not blink the lights and with the power to be used by amateurs limited to one K.W., it is the only way to increase our range.

For C.W. work, especially if the circuit is directly and not inductively coupled, the antenna must not be of too high capacity for use with small sets. This is because, if the antenna is too large, it will draw too much energy from the tube and it will cease oscillating. It is for this reason that so many five-watt sets cover such remarkable distances with small single wire aerials.

A good ground is also of great importance as will be seen by the fact that when using a water pipe as a ground, the radiation meter would not register at all. When the set was grounded to an iron fence the radiation was two-tenths of an ampere and with a counterpoise it was increased to three-tenths.

There are several different five-watt tubes

on the market at present, but the W. E. VT-2 is by far the best. They are not as rugged, however, as the G. E.'s and the plates should not be allowed to get red hot.

Next to the tubes, the most important part of the set is the meters. In order of their importance, they are:

1. Radio frequency radiation ammeter.
2. Plate space current milliammeter.
3. Filament ammeter or A.C. voltmeter.

Without a good radiation meter it is impossible to get the set working properly. The filament meter should be used as a protection for the tube and for finding the filament temperature at which the tube will function best without shortening its life. The necessity for a plate current meter may be seen by referring to an article on the use of the A.P. tubes which appeared in a previous issue of this magazine, which stated that with 15 milliamperes the life of the tube would be about 500 hours; with twenty, 250 hours, and with 50 or 60, about half an hour.

At present there are quite a number of

suitable circuits, but for a lower power set it is advisable to employ conductive instead of inductive coupling.

In the successful five-watt transmitter built by the author, the circuit shown in Fig. 1 was used. This is the same circuit that the majority of record breaking low powered C.W. stations are making use of. The apparatus used is as follows:

- L<sub>1</sub> 35 turns of No. 18 on 4" tube, tapped.
- L<sub>2</sub> Radio frequency choke. Honeycomb No. 300 or 300 turns of No. 28 on 2" tube.
- X Places where modulation transformer may be used.
- C<sub>1</sub> Mica grid condenser, .0005 mfd.
- C<sub>2</sub> Radio frequency by pass, .002 mfd.
- C<sub>3</sub> Series tuning condenser, .001 variable.
- R Adjustable grid leak.
- A Hot wire ammeter. Roller Smith, 0-1.
- M Milliammeter, 0-100.
- T Modulation transformer. Ford coil may be substituted.

The plate current is obtained by means  
(Continued on page 346)

## A Universal Vacuum Tube Unit

By VICTOR H. LAUGHTER

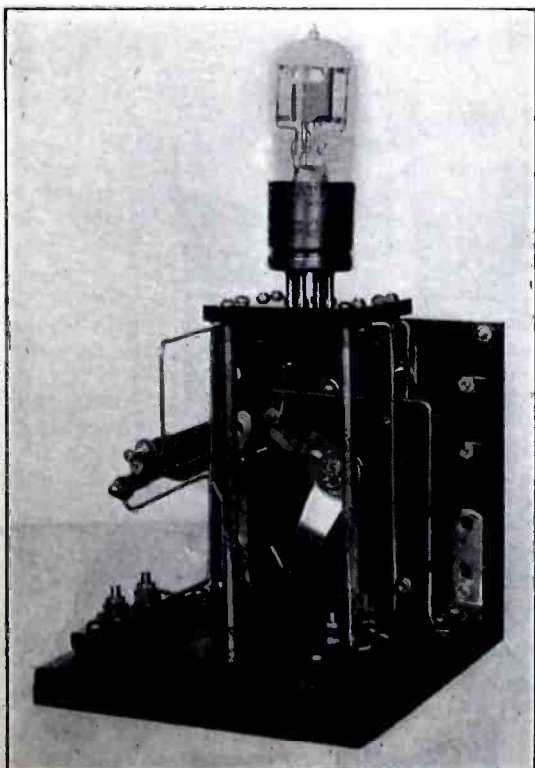

In This Rear View of the Unit May be Seen the Neatness of the Work.

In testing various tubes and tube circuits, the writer has found the need of a control unit that could be adapted for use as:

- (1) Vacuum tube control unit.
- (2) Amplifying unit.
- (3) Power tube unit.

The solution was arrived at by building a unit as shown in the illustrations. It will be noted that provisions are made for mounting the vacuum tube at the top where it is readily accessible when desired to change from one type of tube to another. All connections are made by means of miniature plugs and jacks which give instant connections and disconnections for changing from one type of circuit to another. The telephone receivers are connected to a suitable plug and inserted at "Tel," this contact remaining normally closed. The parts used in the construction were as follows:

- 1—Bakelite panel 5" x 5" x 1/4".
- 1—Celluloid indicating dial.
- 1—Celluloid pointer and mounting.
- 1—Metal disc for back of celluloid dial.
- 1—Rheostat assembly with knob.
- 1—Telephone jack and plug.
- 6—Pin jacks.
- 6—Miniature plugs.
- 1—5" x 6" x 1/2" oak base.
- 4—Right-angle braces.
- 1—Victor socket.
- 2—Supports for V.T. socket.
- 2—Bakelite blocks for mounting of binding posts.

ing posts.

The dimensions of the various parts are not given as the constructor will no doubt desire to drill the panel and make such as necessary to comply with the size of the  
(Continued on page 346)

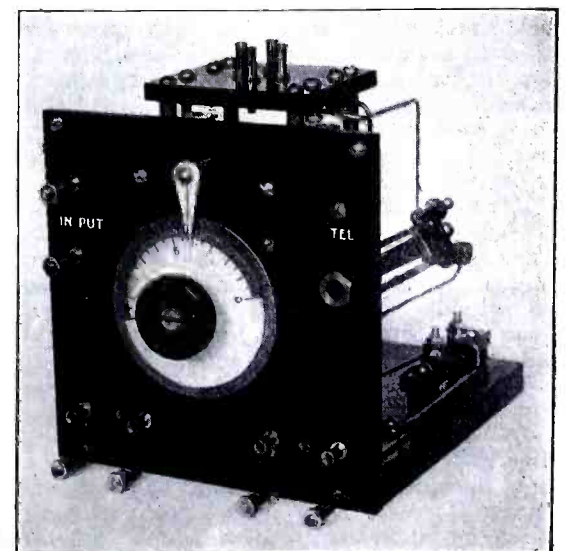

This V.T. Control Panel Has No Binding Posts; All Connections Are Made With Plugs. The Mounting for the Tube is a Departure From the Usual Types Too.



# In a Radio Store

By JAMES ZWEIGHAFT



## Dramatis Personae

THE TIRED CLERK  
THE LONG LEAN HAM  
THE SHORT FAT HAM  
THE FOND MAMMA (accent on last A)  
LITTLE LEON  
THE HARD BOILED HAM

The scene is laid in a modern radio store. In the center of the stage is a large counter and showcase, back of which are shelves of wireless apparatus.

TIME: THE PRESENT. MORNING.

(The stage is empty when the curtain rises. Presently the TIRED CLERK enters, hangs up his hat, and begins to dust off the counter. Enter the LONG LEAN HAM.)

TIRED CLERK (wearily): Mornin'.  
LONG LEAN HAM (briskly): Got any

bulbs? Soft 'uns?

TIRED CLERK: Just one left. You're a lucky man.

LONG LEAN HAM: Great! What kind?

We knew it was coming when we published our first radio playlet! We predicted that we would soon see a new crop of radio playwrites. Our prophecy was not wrong. We have received a number of short plays from which we selected the present one, which is about the funniest thing we have read for many a day.

The plot is simple, and it has the advantage that it is based upon a good deal of truth. Our readers will have a pleasant 10 minutes in reading this playlet.—Editor.

Here is one type of radio bug (see his belt), well known to the radio dealers; he comes to buy a \$100 set but takes only a little coil or a cat whisker for his crystal detector.

TIRED CLERK: A "Weasel," put out by the Blank people. Finest tube on the . . .

LONG LEAN HAM: What! That thing! Why, man, I'd rather use silicon . . .

TIRED CLERK (leaving across the counter with a confidential air): It's not generally known, but I have it on good authority that the Navy has just placed an order for a million . . .

LONG LEAN HAM: I believe you, never mind. Is that the only soft tube you have?

TIRED CLERK: The only one. Seven dollars.

LONG LEAN HAM: What a soak! Gee, they sure do rob you right and left in this game. Well, I gotta have it; wrap it up good. (Lays the money on counter and whistles "Good night, Ladies" while the TIRED CLERK wraps up the tube.) Thanks, s'long. (Exits, still whistling. TIRED CLERK waits until he is out of sight and then mops his brow with a pale green handkerchief. Enter the SHORT FAT HAM. His garter is tangled in his shoe-lace and he looks nervous.)

TIRED CLERK (sweetly): Yes, sir?

SHORT FAT HAM: Have you got a "Weasel" detector tube?

TIRED CLERK: Just one more left. You're a lucky man.

SHORT FAT HAM: I'll say I am! (Enthusiastically.) I never saw the beat of those tubes! They're wonders! Why, last night I copied an Australian amateur on a bed-spring so loud that I could lay the receivers on the table and . . .

TIRED CLERK (hastily): Yes, yes, they're the tube, all right. Seven dollars, please. (Wraps up tube.)

SHORT FAT HAM (hands over the seven dollars and whispers confidentially): You know, the company that puts out those tubes is a bunch of dubs; why, they could get twice the money for 'em!

TIRED CLERK: I guess you're right. Well, come again.

SHORT FAT HAM: Righto! G'bye. (Exit SHORT FAT HAM and enter FOND MAMMA)

(Continued on page 328)

## High Voltage

By RICHARD E. MORRIS

ALTHOUGH the day had been hot and sultry, the evening was cool. Old Man QRN having given up the ghost, conditions were ideal for Radio. The writer was at his old hobby. A little listening in soon proved that many other amateurs had also taken advantage of the fair conditions. The air was filled with a continual buzz of local "Hams," with a distant relay station breaking through now and then. As the hour grew late, only the big DX men were at work, and finding myself nodding I turned off the light and settled down in the chair.

How long I sat there I do not know, but at length I arose, went downstairs and put on a pair of rubbers, although no rain had fallen for a week. Out in the shed I obtained a large roll of wire and a ladder and with this equipment I slipped out into the alley. At this point it might be well to state that I had been affected for some time by a disease known to Radio amateurs as C.W.; also, that all my attempts in this line had failed, due to the lack of the necessary potential. But getting back to the story, I reeled out some 500' of wire, stringing it to any object which came to hand. The time was something near two P.M. in the morning, a fact which laid me open to all sorts of suspicions, from murder in the first degree down to dealing in Moonshine. Nevertheless, I worked on in

silence. The plot was this: The ether had it that a bright youth in Watertown, U. S. A. (wherever that is) had tapped the line of the local trolley company, thereby obtaining 550 volts D.C. for the plates of his hungry tubes. The idea struck me as a good one. However, I thought it best to try out the scheme before getting the official disapproval. Accordingly, I placed the lad-

(Continued on page 332)

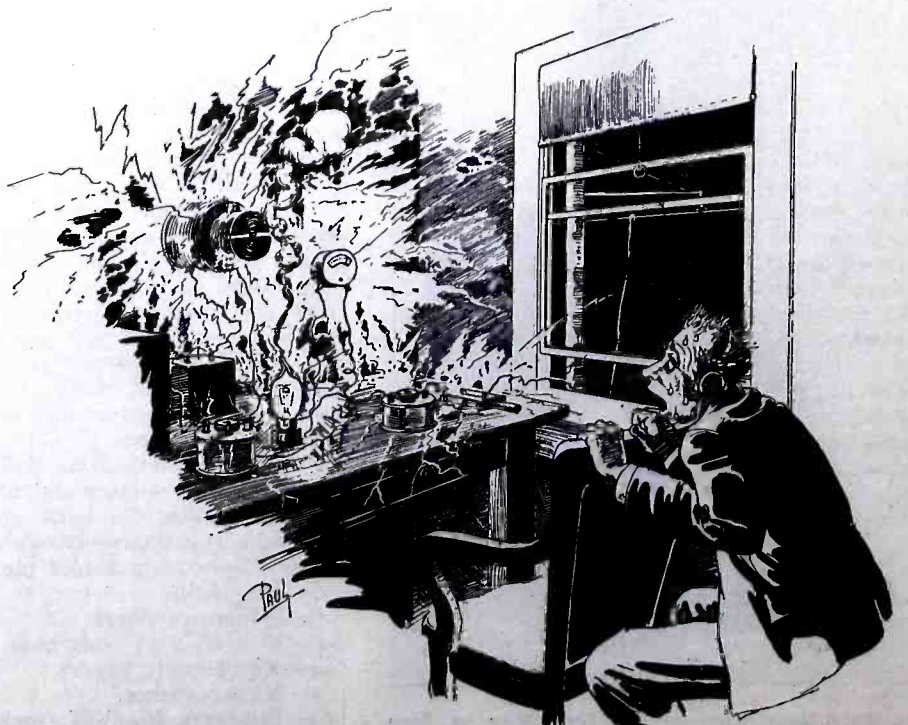

The Arc Which Followed the Wire Was Like Lightning. I May Have Seen Double, But Anyway it Was Some Fireworks!



# Ghosts by Radio

By GEORGE M. BRAMANN

**H**ALLOWE'EN, like Christmas and birthdays, comes around once every year, and so when Hallowe'en was but a week away, Buddy Thomas, President of the Chester Radio Club, which had a large and flourishing membership of 15, decided he must celebrate this Hallowe'en if he never did another.

Hallowe'en, Buddy reasoned out, was a night for spooks. So spooks he must have, and as he was a radio bug, quite properly they must be radio spooks.

Unknown to his fellow club members, he had just received all the apparatus necessary to finish his C.W. set. Here was material for plenty of spooks, if properly managed, and so Buddy kept quiet about receiving it. For the next three days he was busy erecting his new set, but finally, late Wednesday night, he finished it.

After calling all the "hams" in town on spark, and making sure they were not at their sets, he finished the final tuning up and adjustments. Hallowe'en came on Monday, and so on Sunday night Buddy let loose a few preliminaries. At 10:30 that night there broke into the ether the weirdest music the Chester "hams" had ever heard. It certainly had the ghostly sound, for when it stopped the air was full of "Did you hear that, O.M.?" "What was it?" "Whose 'phone set went wrong?" and the like, and Buddy, playing possum, was as ignorant as the rest.

After a half hour, the air quieted down a little and so Buddy took another chance. After playing the song once again, in a deep, low monotone these words came forth via radio:

"All spirits, attention! The annual assembly of the spirits of Chester and surrounding townships will be held tomorrow night, as the old church clock strikes twelve, in the old schoolhouse on Turkey Hill Road. All spirits must be present. Business of great importance to be discussed."

He followed this speech with another "ghostly" piece of music, as a sort of conclusion which would give his audience a chance to forget the exact sound of his voice.

As soon as they found that there was no more ghost talk, excited queries filled the Chester ether, most of them being "What is it?" "Where does it come from?" and the like. Eventually, as Buddy thought would happen, someone suggested meeting the next night at eleven o'clock in front of the post office and going in a body to see the "ghosts." This provoked a lot of discussion, during which the ether got jammed several times when 10 fellows tried to talk at once to the same person.

Eleven o'clock the next night found 20 determined youngsters, several with flashlights and nearly everyone with a club or baseball bat, gathered in front of the post office. Every club member was there and five of them had enlisted their brothers.

Buddy, as President, led the way. He had other reasons, too, for desiring to guide this group of unbelievers. As they neared

the schoolhouse, they stopped to hold a conference. They decided, with the aid of Buddy, to get up on the hill alongside of the school where they could look in the windows and see all that went on. They again followed Buddy's lead and picked out the very spot on the hill where he wanted them to be.

A few minutes later, they heard, coming softly from the town, the sound of the church clock striking midnight. Just as the last stroke died down, there came simultaneously from the schoolhouse a piercing scream and a blinding flash of light, which lit up the interior of the building like day. The more nervous ones in the party began to look for a way in which they could quietly vanish, but they found to their surprise the only way out was past the schoolhouse. Buddy had maneuvered them into



And Again Came That Piercing Scream and Blinding Flash of Light, Which Had No Sooner Disappeared Than Another Great Streak of Fire Shot From the Schoolhouse Chimney.

a brier patch with but one way out, which they were afraid to take.

For a minute there was darkness inside the schoolhouse, and then to the eyes of the excited onlookers a soft light seemed to diffuse itself over the room, and by this light hazy figures could be seen moving around. This light slowly faded from view, and then, in absolute darkness, for there was no moon, a stentorian voice called out "The meeting will come to order!" and continued, "Sentinel, may the meeting proceed?"

"It may not, sir, for outside are material beings of the other world, ready to listen to what we have to say."

"Out and haunt them!" cried the chief in a voice like a cannon's roar.

And again came that piercing scream and blinding flash of light, which had no sooner disappeared than another great streak of fire shot heavenward from the schoolhouse chimney.

Dick Arnold and Jack Pierce could stand it no longer, and openly tried to make their escape through the brambles in the rear, when almost from under their feet came the loud command, "Halt!" They turned and fled, this time past the now deserted

schoolhouse and along the road towards home. They had had enough.

So had the others, and they were all anxious to leave, and someone lit a flashlight to better find his way. Unfortunately, it fell on Buddy, who was rolling over and over on the ground, a handkerchief stuffed in his mouth and his face convulsed with laughter.

Comprehension was instant on both sides, and Buddy tried a dash for liberty. He was quickly downed, and 17 angry voices demanded an explanation. No one likes to be fooled.

"Lemme up, lemme up," came faintly from the bottom of the pile. He was dragged to his feet, still smiling.

"Well, fellows," he said, "it was this way . . ." and taking a flashlight he showed them a box buried in the ground, full of switches which had controlled the magnesium flashes, the loud speaker and the magic lantern, and the button which had set off the rocket up the chimney, as well as the microphone into which he had talked.

"How about the music?" asked his questioners.

"Oh, that's my new C.W. and phone set. Come around tomorrow night and I'll show it to you."

## A New Invention for the Non-radio Man

By A. M. QUAID.

Materials needed for making this famous Bussiotron: A small piece of candle (any kind may be used). A piece of metal for the plate. A curled piece of wire for the grid. (If the beginner finds difficulty in understanding these above mentioned animals it may be found in the book entitled "The How and Why of Lawn Mowers.")

In order to place this bulb in operation, a match must be at hand to light the filament (safety match preferred). After the filament has been lighted be sure that there are no drafts or the filament is liable to touch the grid, but in most cases the filament goes out. If the grid should become smoked from the filament it can easily be cleaned again as it will work better if free from soot (given off by the filament).

This bulb will prove very effective with a low plate voltage, as the bulb is likely to melt the wax if a high voltage is used. It may be necessary to discontinue the use of the bulb in order that it may become hard.

A very efficient receptacle may be had by placing the bulb in a saucer, as this will catch any stray ions that may become restless while the bulb is in operation. As this bulb has a grid having in its interior a special liquid, the liquid automatically leaks out of the grid and therefore the cost of a regular grid leak is eliminated. When once the filament has been lighted it is not necessary to adjust it, hence—no rheostat. This bulb has proven very sensitive as a renovator, excavator, illuminator, refrigerator and other things with an "or" on the end.



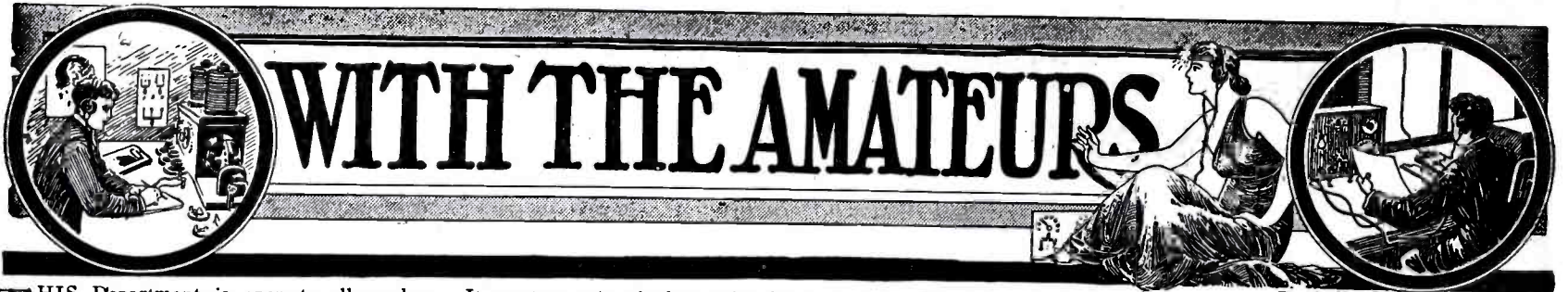

# WITH THE AMATEURS

THIS Department is open to all readers. It matters not whether subscribers or not. All photos are judged for best arrangement and efficiency of the apparatus, neatness of connections and general appearance. In order to increase the interest in this department, we make it a rule not to publish photographs of stations unaccompanied by a picture of the owner.

We prefer dark photos to light ones. The prize winning pictures must be on prints not smaller than 5 x 7". We cannot reproduce pictures smaller than 3½ x 3½". All pictures must bear name and address written in ink on the back. A letter of not less than 100 words giving full description of the station, aerial equipment, etc., must accompany the pictures.

PRIZES: One first monthly prize of \$5.00 All other pictures published will be paid for at the rate of \$2.00.

## 3AIC, Reading, Pa. THIS MONTH'S PRIZE WINNER

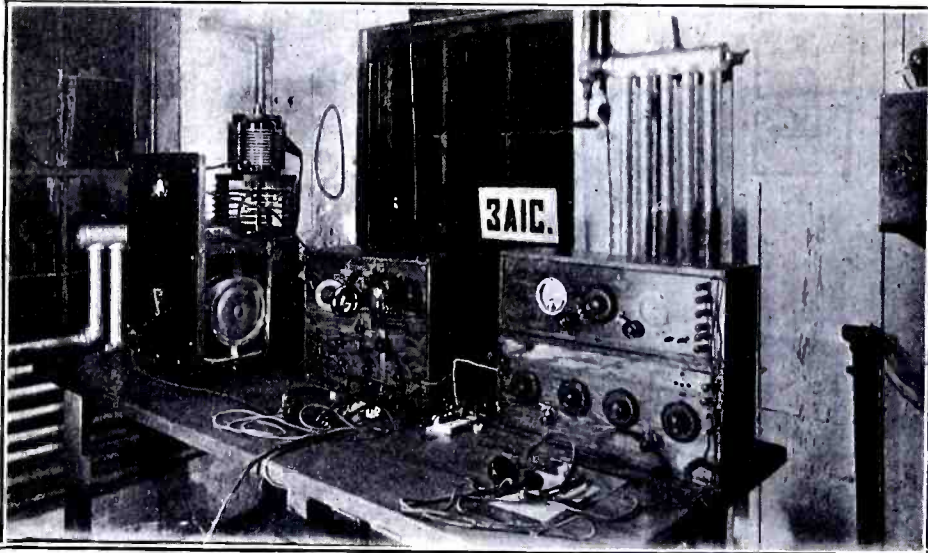

.....  
This equipment was built by the students of the high school. Pretty good work, isn't it?  
.....

The accompanying photograph shows Station 3AIC, located in the Practical Arts Building of the Boys' High School at Reading, Pennsylvania. This station was built by the students last fall and put into operation about the first of this year. It has done fairly good work when its small power and limited working hours are considered. During the winter months, while night school was in session, it operated on Monday, Tuesday, Wednesday and Thursday nights from 7:30 until 9:30. It is still working since the close of night

school, from 12 o'clock noon until 5 p. m. Using a ¼-K.W. Acme transformer and working during the hours when the local QRM was heaviest there was no trouble in working 450 miles and over, almost every evening. Stations as far north as Maine and as far south as the southern part of Virginia, have us logged at various times. One station in Massachusetts reported us audible ordinarily five to six feet from the phones. Although built by night school students, it is operated by students from the day school, so that credit must be given to all. The two operators are Fred De

Long, who signs F. D., and Paul Naftzinger, who signs P. N. The sending equipment is as follows: ¼-K.W. Acme, Dubilier .007 condenser; Benwood Gap with a ten-stud rotor running at 4,500 to 6,500 r. p. m. A Marconi type O. T. using one turn in the primary and six turns in the secondary, the coupling having been further loosened since the picture was taken. The aerial is 65 feet long, four wires placed three feet apart inverted "L" type. The aerial is 70 feet high, the set being located on the fifth floor and having a ground lead about 55 feet in length, grounded onto a six-inch water main. The roof, the radiators, the sprinkling system, the gas and water pipes, in fact, everything in sight was at first used as a ground. It became a common saying that if a nickel was dropped on the floor someone would solder a ground onto it. Various tests were made, until they were all eliminated with the exception of the water pipe and the roof. The hot wire ammeter gives a reading of 2½ amperes. Despite the fact that the set was located on the fifth floor the above distance was readily covered, which was made possible by the addition of an inductance at the base of the ground lead.

The receiving set is a home-made regenerative with one step of amplification and a volt meter and ammeter with the necessary change-over switches, so that the operator at all times may know the plate voltage and filament current of either tube.

(Continued on page 354)

## 9 AVC, Hastings, Neb.

The receiving equipment at my station consists of long and short wave regenerative receiver, built by myself and of my own design, Moorehead detector, and two-step amplifier. I have available from 200 to 25,000 meters in honeycomb inductances and 175 to 800 meter vario-coupler for the tuning with the usual variable condensers.

The transmitting equipment is a 1-K.W. Thordarson transformer, signal plate glass condenser, and C. & W. Co. enclosed rotary quenched driven by belt.

The aerial is a 6-wire, inverted "L," 60 feet long and 42 feet high with a wavelength of 194 meters.

With the receiver I hear all of the high power stations in the United States and in Europe, POZ and LN. I also hear Cavite, Honolulu and Pearl Harbor. On the lower waves I often hear amateurs on both coasts.

With my transmitter I have a good DX record, having worked in all directions over 800 miles and I have been heard over a thousand miles, and with the coming season

I intend to install I.C.W. and phone so that I ought to make a fairly good relay station for the next winter.

ROBERT M. STEPHENS,  
Y. M. C. A.,  
Hastings, Neb.

.....  
Although Bob has this nice 1 K.W. set, he is coming to the C.W. too. We hope to see his tube set here when it is built.  
.....

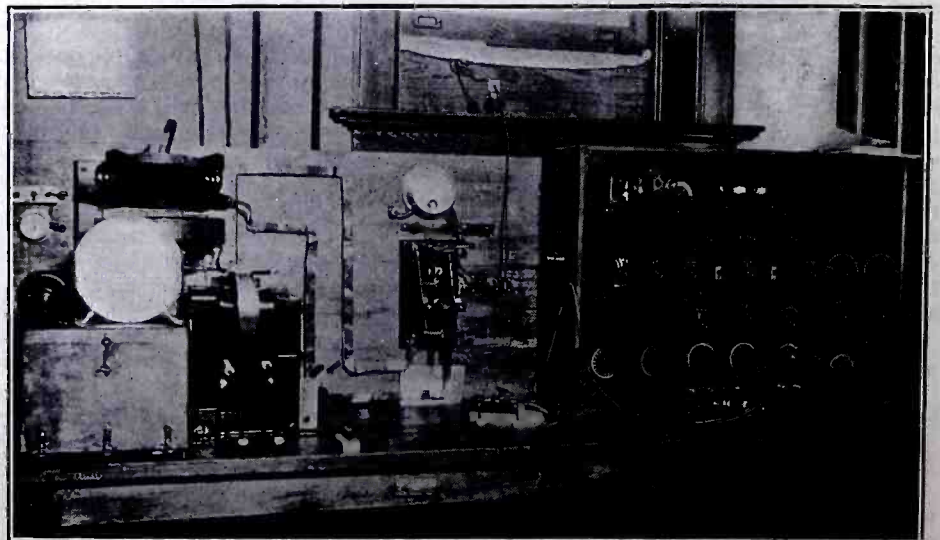



# 8 APH, Toledo, Ohio

I am herewith sending you a picture of my station 8APH, Toledo, Ohio. The following is a short description of it:

The entire set is built up of units  $4\frac{1}{2}$ " x  $4\frac{1}{2}$ ", to the entire number of twenty-four. Half of these are used for receiving and the other half for transmitting. The receiving set is made up of detector and two-step amplifier. Two more steps of amplification may be hooked in at will at the output of the entire four stages; there is a magnavox, to amplify the signals to such an extent that signals may be heard for a distance of one city block. Music and speech were received here with such tremendous loudness as almost to be unbelievable. Four variables are in use and a set of honeycomb coils and mounting for same.

The transmitter occupies the other twelve panels and consists of two Cunningham transmitter tubes, two variables, 30 turn inductance and a rectifier to rectify 60 v. alternating to D.C. A microphone and buzzer and pure C.W. are my transmitting methods.

Ammeter in the ground circuit and change-over switch.

The following is some of the work done by my transmitter: My music was heard

.....  
 This combined transmitter receiver in panel units makes a good arrangement; a good idea you had Frank.  
 .....

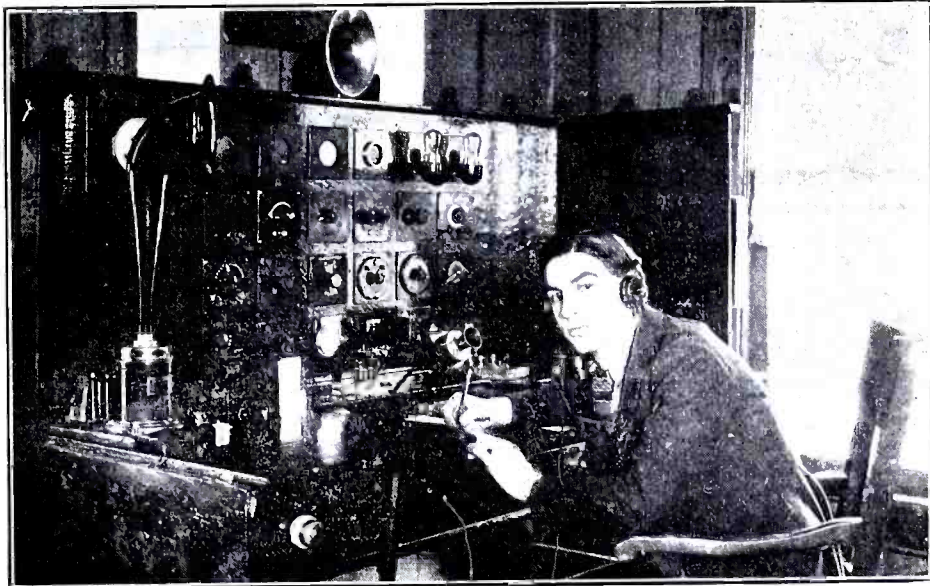

at Fremont, Ohio, and Detroit, Mich., and my straight C.W. carried QSA as far as Bristol, Connecticut, a distance of over 500 miles, not at all bad with only 50 watts input.

The receiving of course is as good as any

I have ever heard or read about. I have received Hawaiian Islands; Lyons, France; Nauen, Germany; and Rome, Italy, in broad daylight, and amateurs and 600 meters come in just as good.

(Continued on page 348)

# 7 HM, Great Falls, Mont.

The following is a description of my station, 7HM:

The antenna is of the inverted L type, composed of four wires, 40 feet high and 85 feet long. The ground is as important, and even more, than the antenna. I use gas-pipes, water-pipes, watermains, and rods driven into the ground.

The receiving set is small, but I obtain excellent results, using only one bulb and the standard tickler circuit. I use both audion and crystal for detecting. A 5,000 meter loose coupler, DeForest audion control panel (type P-401), loading coil, Murdock variable condensers, Holtzer Cabot phones, storage battery and "B" battery (installed under the table) and a wave-meter (in extreme back-ground), complete the receiver. I am now planning on a regenerative set with 2-step audio frequency amplifier. I have heard, lately, NPG, NNA, NGP, KMS, WSM, KNG, KMT (Alaska), 7XB, 7DK, 7XK,

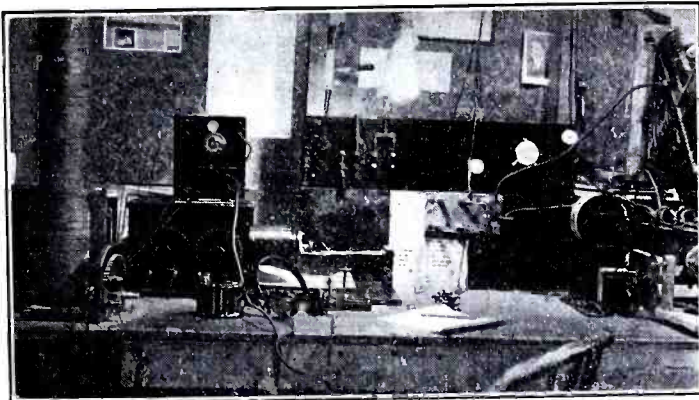

Here is One of Those Good Ol' Loading Coils Still on the Job. They Don't Look so Compact, But Are as Good as More Complicated Types.

KLQ, and many other commercial and amateur stations.

My transmitter is composed of a Thordarson  $\frac{1}{2}$ -K.W. transformer, high speed rotary gap of the sawtooth design, oil immersed, glass plate condenser, and a hinged,

pancake type oscillation transformer. I have not done much "DX" work this winter, but have been heard by 7GQ, Eugene, Ore., a distance of about 600 miles air line. I can be heard at almost any time over the entire State, especially by 7EX (250 miles) and 7XB (175 miles).

There are not many amateurs out West here in Montana and Wyoming, and we are a little slow in developing the Radio game. There are, nevertheless, a few phone stations in Montana used by the Forestry Service.

In conclusion, I would be pleased to hear from amateurs interested in Western amateurs still using spark sets, for I fully realize that a C.W. set would be much more efficient; but up to the present time, owing to certain conditions well known to many of us, I have been unable to make one.

MERWIN B. ELTON,  
 Station 7HM.

# 9 GI, Weedman, Ill.

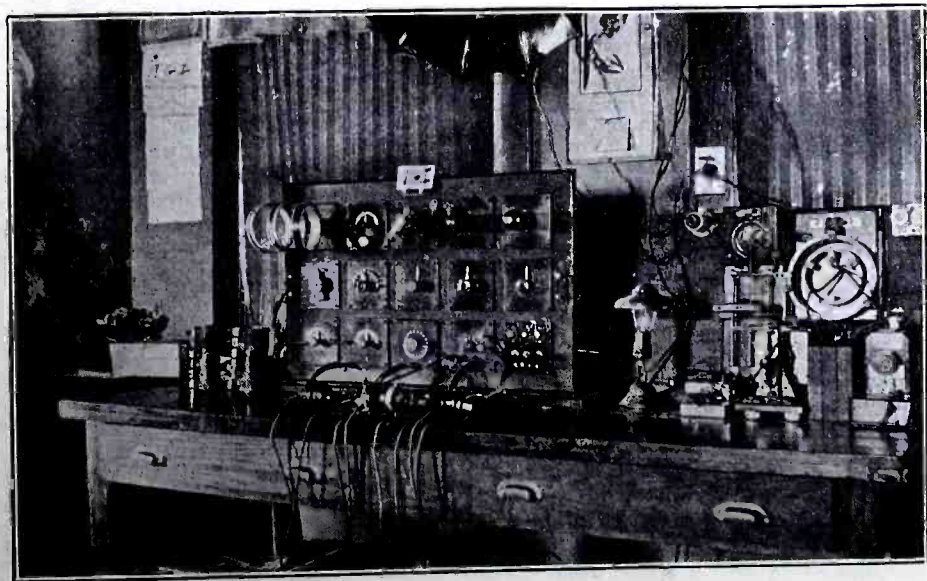

.....  
 A nice station with a transmitter using a quenched gap with a spark coil. Q R Mers please note.  
 .....

I am sending a photo of my station and would be pleased to have it published in RADIO NEWS.

A description of my station is as follows: The aerial is a four-wire "T" type 60 feet high and 80 feet long. The ground is an insulated counterpoise suspended a few feet from the ground on the same masts as the aerial which it is exactly like. The receiving set is a DeForest unit panel type consisting of fifteen panels comprising tickler coil regeneration, a detector and two stages of amplification.

Mounted on one panel are three telephone jacks connected in series, which in turn are plugged into the detector or stage jacks, thus allowing three pairs of phones to be plugged in at the same time.

Four and one-half inch single layer coils are used for short waves and the regular honeycomb coils for longer waves and arcs. All panels in this set and the short wave,

(Continued on page 355)





## Junior Radio Course

### The Radio Compass

#### PART TWO

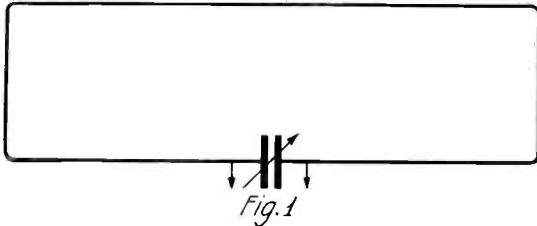

This Type of Loop Aerial Has More Accurate Directional Properties Than the Square One.

**I**N direction finding work, various types of coil aeriels are used. In the last lesson were described a few types and the methods of taking the bearings to determine the positions of ships at sea, or airplanes while in motion.

In this lesson we shall speak about various forms of loop aeriels and their respective directional effects, as found by practical experiments. As was explained in the last lesson, the efficient area of a square loop aerial is in the form of two circles on each side of the loop, and in its plane.

If the loop is given the shape of a rectangle, Fig. 1, the efficient area is of another shape, as shown in Fig. 2, and the longer the loop, the more marked is the directional effect. It has been found that the directional effect of a loop, very long in comparison with its height, is very sharp, and only stations which were in the plane of the antenna could be heard, while some other stations at a shorter distance, but only a few degrees on each side of the plane, were absolutely inefficient and their signals could not be heard.

The same peculiar effect may be noticed when an ordinary L aerial, long enough and grounded at the free end, is used for receiving. The ground acts in this case as the base of the loop, as shown by the dotted line, Fig. 3. However, this sharp, directional effect is more noticeable on certain wave-lengths, and is less efficient for transmission.

For the reception on short wave-lengths, a triangular loop, illustrated in Fig. 1C in the last lesson, is often used. This loop consists of one turn and has a different efficient area from the square or rectangular loops. The active field of such a loop is shown in Fig. 4. As may be seen, it is advantageous especially for distant stations, as the sharpness of the field is greater at a certain distance than the one of a rectangular loop.

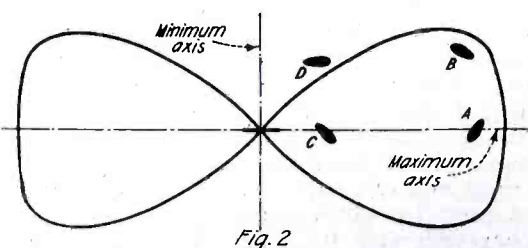

Approximate Shape of the Efficient Receiving Area of a Rectangular Loop.

If, for instance, a ship station such as A in Fig. 4, is sending, it is received with maximum audibility, while a ship in position B is not heard. If a rectangular loop were used, the ship B would be heard also with almost the same intensity as A.

Now, supposing that a ship station is close to the radio compass, such as C, Fig. 2, more accuracy is to be had by the use of a rectangular loop, for as may be seen, the ship D is not heard in the receiver, while with a triangular loop the transmissions of both ships would influence the aerial, being both in the active field of the loop. Of course, these effects are more noticeable on certain wave-lengths and under certain conditions and may vary with the locations of the stations and whether they are installed on the shore, or inland; they vary also with the weather and atmospheric conditions at various times of the year. However, the shape of the active field of the various types of loops, as given in this lesson, is about true at all times.

The loops just described are of the solenoid type, that is, they are wound as a

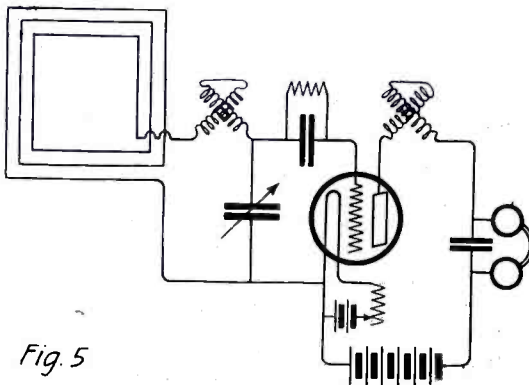

This Regenerative Circuit May be Used with a Loop Aerial in Direction Finding Work.

coil; to obtain a more accurate directional effect the loops may be wound pancake style, so that all the turns are in the same plane, as in Fig. 5. In this case the plane of the loop has only the thickness of one turn, although the inductance is increased and when turned around its axle to find the direction of a sending station, it may be noted that the points of maximum and minimum intensity of reception are very sharp and somewhat easier to find than when a solenoid loop is used.

#### RECEIVING APPARATUS

As a loop aerial is generally small in size in order to be turned in all directions easily, some sensitive receiving apparatus should be used in conjunction with these aeriels. Due to its rather poor sensibility in comparison with the vacuum tube, the crystal detector is not practical, and generally an amplifier, either of the radio or audio frequency type, is used, although some good results may be obtained with only a V.T. detector.

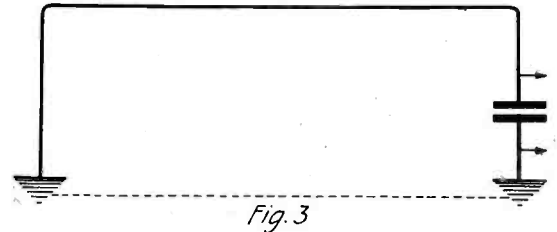

An Inverted L Aerial with the Free End Grounded Constitutes a Loop Having its Base Constituted by the Ground.

No additional tuning is necessary, as the loop is directly connected to the detector or amplifier in the same way as the secondary circuit of an ordinary receiver. For the reception of continuous waves, or if a regenerative circuit is to be used, the loop takes the place of the secondary of the coupler, as shown in Fig. 5.

#### SIZE OF THE LOOPS

The loop aeriels, in order to be revolved in all directions, are generally mounted on a shaft on which is fixed a dial divided into 360 degrees, a pointer fixed on the base supporting the loop shows the direction from which the signals come. The frame on which the loop is wound varies in size according to the requirements of the work, but is generally from 3' to 6' square. For short wave reception, one to three turns are used, spaced about  $\frac{1}{2}$ " apart. For medium waves more turns are used and may be wound closer together. For long wave reception, smaller loops may be used with the turns close together, as in an ordinary tuner provided an amplifier is used.

#### TRANSMISSION

The loop aerial is not at all efficient for transmitting, as the closed circuit does not radiate much energy. For experiments and for short distance work, it may nevertheless be used with continuous waves, as generated by vacuum tube transmitters, the loop being used as the tuning inductance of the set.

Of course, the directional effect is noticed at the transmission as well, but a long range cannot be obtained for the reason above explained.

A type of loop aerial more adapted for transmitting is the flat spiral type, shown in Fig. 5. In this case only one end of the loop is connected to the transmitter instead of the regular antenna, and either the ground or another similar loop used as a

(Continued on page 354)

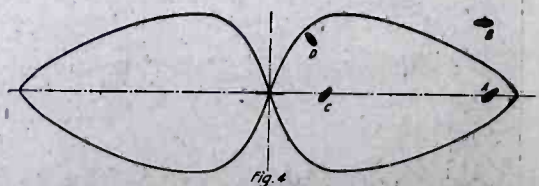

The Effective Field of a Triangular Loop is Approximately of the Shape Here Shown; Compare with Fig. 2.



# Junior Constructor

## AERIAL WIRE CHEAP HERE.

Here is a new use for worn out Ford magnetos.

When your dad's Ford wears out, don't let him put it in the ash can, but persuade him to let you have the old magneto coil assembly. What for? Take a look at the accompanying photograph and just imagine how nicely all that copper ribbon would serve as an aerial.

There are about 180 ft. of ribbon on a Ford magneto, and a couple of magnetos would indeed make a good aerial for most any amateur. The old magneto can be had for little or nothing from any Ford repair shop.

Contributed by K. STRICKFADEN.

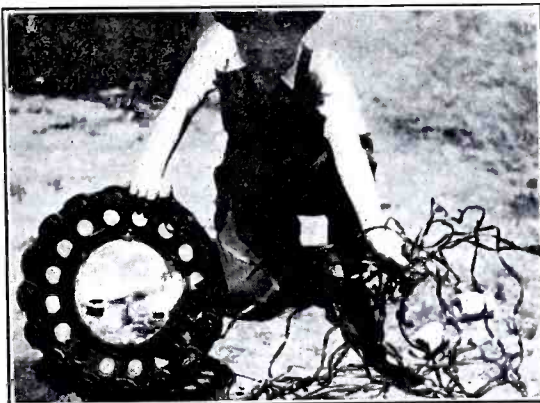

Did You Ever Think of This? There is Plenty of Useful Wire in an old Henry Magneto. Why Not Use it for an Aerial.

## A SKINDERVIKEN OR MICROPHONE AMPLIFIER.

An inexpensive and quickly-made amplifier may be constructed with a high resistance telephone receiver (about 2,000 ohms) and a Skinderviken transmitter button. Find the exact center of the receiver diaphragm and drill a hole through which the screw of the button can slip. Make connections to the two binding screws of the transmitter button and connect the instrument to a telephone induction coil, battery, and low resistance receiver, as shown in diagram.

If no Skinderviken button is obtainable, the same device may work with a home-made microphone, as follows:

First, secure a sensitive receiver of about 2,000 ohms resistance. To the diaphragm solder a small brass cup, at the center, and

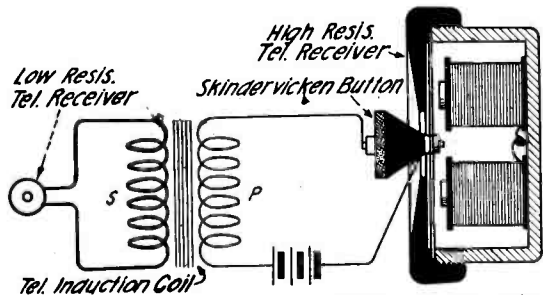

This Amplifier is Simple to Make, it Consists of a Microphone Button Mounted on the Diaphragm of a High Resistance Telephone Receiver With a Local Circuit.

a wire at the edge. Fasten the receiver to a wooden base. Now make a brass bracket of the form shown, drill and tap a hole at the place indicated. Remove a carbon from an old flashlight battery and solder it by its brass cap to the end of a piece of threaded rod. Run the rod through the hole in the bracket and put a hard rubber knob on the other end. Make connections, as shown, to a battery, telephone induction coil and low resistance telephone receiver, and the amplifier is ready to amplify.

Contributed by JOSEPH LIEBOWITZ.

## HIGH POTENTIAL BATTERY FOR RADIO RECEPTION CIRCUITS.

A high voltage or potential battery is required in the operation of the plate circuit of the vacuum tube with a small amperage. The audion or vacuum tube when used as a detector, operates with a plate potential of about 40 to 60 volts and when used as an amplifier requires a potential of 60 to 100 volts. Such voltages are usually obtained from a flashlight or dry batteries and which are quite expensive, especially as they can not be recharged and made to last indefinitely.

The battery described here is of the type made by the early investigators and is now used in the laboratory and known by the name of the bichromate cell. It is of the single fluid type, has a high E. M. F. with low internal resistance with a fairly large current. When used for the "B" side of

the vacuum valve connections, it will give excellent results and is rechargeable when run down. Odd scraps of copper and zinc are used in its construction.

To make a battery with a potential of 60 volts, it will be necessary to build up the required number of cells, allowing one and one-half volts to the cell, as it will drop to this after a short use, the initial voltage being higher. Therefore 40 cells will be needed. Each cell or unit is composed of a sheet of copper about  $\frac{1}{8}$ " in thickness and 4" square, a sheet of zinc of the same dimensions and a piece of pure all wool cloth, firmly woven and of good thickness cut  $3\frac{3}{4}$ " square. Any cotton in the cloth will be eaten away by the acids, as is usual in the material tests for all-wool cloth.

A container or battery box should be built to hold the parts as illustrated, the interior dimensions being about  $4\frac{1}{2}$ " square, the height depending upon the number of cell-units to be contained, but in the 40-cell unit the inside height should be 9" if the materials are  $\frac{1}{8}$ " in thickness and the cloths somewhat thicker. Cut 40 pieces each of the copper, zinc and wool, polish the metal squares with sandpaper or emery-cloth, place strips of wood across the bottom of the inside of the case, then place a long screw and knob through the top and through a piece of brass drilled and threaded and screwed to the top of the case, as shown.

Make up the electrolyte solution in a glass dish using a glass rod to stir it; bichromate of potash, one ounce, dissolved in one-third of a pint of boiling distilled or rain water and when cool add very slowly, stirring continually, one ounce of chemically pure sulphuric acid, the commercial acids being very unsatisfactory.

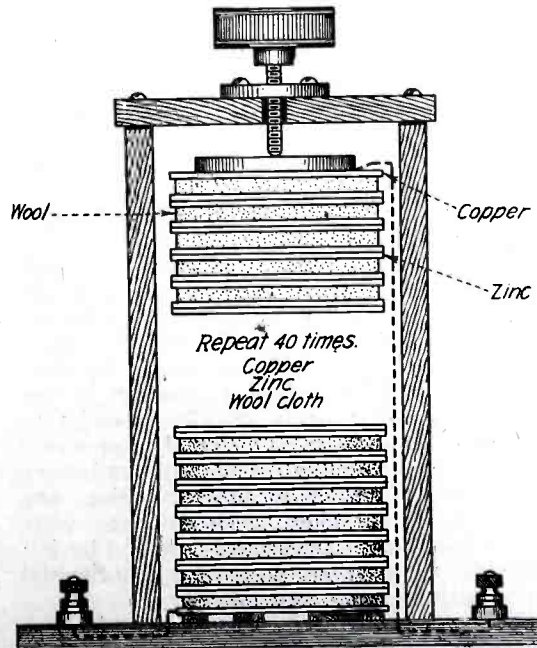

This Type of High Voltage Battery May be Used as a "B" Battery and is Refillable.

Place the woolen cloths in this solution so that they will become completely saturated; solder a wire to one corner of a sheet of zinc and place the zinc at the bottom of the case, connecting the wire to the binding post; this will be the negative terminal. Then place a piece of the cloth, well drained so it will not drip, on the zinc, then a sheet of the copper. Put a zinc on the copper, then wool, then copper, zinc, etc., repeating the combination 40 times. The zinc and copper touching will connect the different units in series; zinc, cloth and copper making up one unit cell. The last piece is copper, which has a wire soldered to it and connected to the positive terminal of the case. A piece of metal or heavy wood is placed upon the top of the pile under the screw to make it all rigid. The screw is turned down to press all firmly together, but not too tightly. After the battery has been in use some time and the cloths have become partly dry, a few turns of the screw will bring all into a better contact and raise the potential. After it has completely run down, the parts are to be removed and the cloths saturated again in the solution and put together. After the zinc has all been completely eaten away by the acid it will have to be replaced and the copper polished again with an emery cloth, after heating to a dull red heat and cooling slowly to burn away the acids and zinc that have corroded to the copper.

The inside of the case should be given a coat of shellac or of paraffin wax and the

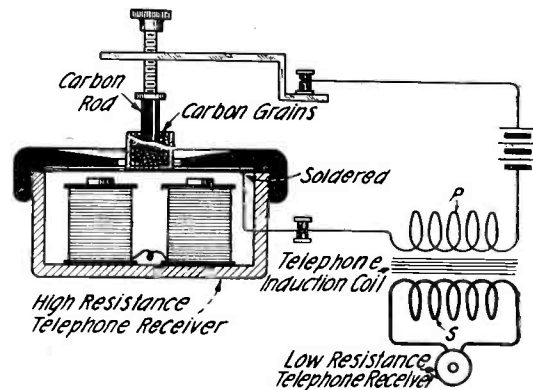

You May Build This Microphonic Relay to Boost up Your Signals.

edges of the metal squares should be painted with paraffin so as to prevent the electrolyte from creeping around and making short circuits, thus causing impaired efficiency.

Contributed by FRANCIS DASHIELL.

(Much better results will be had if we use carbon discs instead of copper. The zinc plates should be well amalgamated on both sides.—Editor.)

## REJUVENESCENCE OF THE DRY CELL.

I accidentally hit upon a new method of rejuvenating dry cells a few months ago, which may be of interest to others. I had shorted the "B" battery of my wireless receiving set, and found that my whole battery of "Eveready" cells had run down.

I was warming the station that evening, as it chanced, with an oil heater, and I laid one of the cells that would no longer make a one-volt incandescent lamp glow on top of the stove, and rolled it around until it became somewhat warm. Then I threw the little bulb in circuit again. To my surprise, it burned quite brilliantly. I tried warming the others with equally good results.

After warming up the entire battery, I put it back in my set, and found that it worked as well as ever. By the next day, however, when the cells had cooled off, the battery again refused to work well. Then I took the cells and set them all on a hot stove, with the theory that if a little heat

(Continued on page 328)



# Correspondence From Readers

## GOVERNMENT LINKS WITH AMATEURS.

Editor RADIO NEWS:

Having read several articles in the July issue about Aerial mail and radio vacations, I thought perhaps this would interest you.

Uncle Sam has much confidence in amateur radio operators. So much, in fact, that he has at last given us a chance to prove ourselves.

The forests of California are patrolled daily by airplanes.

The U. S. Government has hired amateur radio operators to operate receiving stations at different Supervisors' Headquarters throughout the National Forests of California.

As I am one of these operators, I will explain it all in detail.

The Government sent letters to all the radio amateurs in California inquiring as to their knowledge of radio, etc., then the lucky ones were appointed.

There are about 20 receiving stations that are operated by amateurs. These, as far as receiving is concerned, are complete in every detail.

The airplanes leave their bases about 9 A. M. daily and have a regular route which they follow. They report positions every 15 minutes and by this the land stations know exactly where they are at all times.

The main thing is to report forest fires. They report fires by township, range and section.

The planes fly between 10,000 and 15,000 feet, because the forests are not very good places to land, so in case anything goes wrong, they have a better chance to land in the valley.

They have sub-bases where they land for dinner; there are also emergency fields where they can land, if necessary.

The receiving stations are mostly located in the mountains, thus combining a vacation with work for the amateurs.

It is not hard, but it is every day, Sundays included, in this line of work. The airplanes cover on an average of 400 miles a day.

I am located up in the mountains at an elevation of 4,500 feet.

HERBERT LAVENDER,  
Radio 6LU.

Willows, Calif.

## THOSE EDITORIALS.

Editor RADIO NEWS:

Your July number of RADIO NEWS did not entirely please us because you omitted, I believe, one of the greatest factors of its success—your editorial. Now, it is so hard for us to believe that anyone really interested in progressive Radio should urge you to discontinue the editorial, that we sometimes think you have merely given us a bit of fiction as a means of ascertaining just what we do think of them.

Your editorials are just right, but sometimes seem a trifle short. By all means, let us have a good long editorial each month.

O. H. KNAPP.

Salona, Pa.

## AGAIN THOSE STORIES.

Editor RADIO NEWS:

This is in reply to the letter written by Mr. Prescott Smith in the August issue of RADIO NEWS.

It certainly surprised me to learn of the vast knowledge accumulated by Mr. Smith while a radio operator. Indubitably, the gentleman prefers monotonous but consistent radio stories which relate incidents appertaining only to indisputable facts. Let Mr. Smith avoid the fiction and turn to educational articles, and thus broaden his present amazing store of radio information.

Mr. Smith has ostensibly never experimented with kites for radio work, much less captive balloons. He had better turn to page 101 of RADIO NEWS for August and learn how to make a kite for experimental purposes. The results obtained with its use will doubtless change his opinion about a captive balloon with necessary apparatus and operator being capable to intercept messages very much louder from great distances than if the instruments were close to the earth.

Mr. Smith had better go to Japan and try to decipher some of the Japanese special codes. Too bad the gentleman criticises without competent authority but nevertheless I appreciate his remarks; it shows he read the story.

I am sorry "Martian Madness" left a "bad taste," but no doubt the gentleman has since bought a fiction magazine and has now lost the repellent taste of the radio story.

ERALD A. SCHIVO.

San Francisco, Calif.

## THE JAPANESE CODE.

Editor RADIO NEWS:

In looking through the RADIO NEWS for the month of August, I found a letter in the "correspondence from readers" department, a printed letter in which a commercial operator asks: "Who told Mr. S. that the Japanese use a different code from us?"

It is not my intention to interfere in their discussion, but this questioning by an operator infers that they do not use a "different code from us." If he believes this, it is a great mistake, for the Japanese do use a different code than the International, and they can use that code, too. It might be well to explain this briefly, in order that readers may not misunderstand the system in use.

The Continental code, or International code, was constructed for languages written and expressed in the Roman-Arabic characters. Several additional characters of languages other than English were necessary to facilitate communication in those languages, and were appended to the original twenty-six letters of our alphabet. For any of the Latin languages, English, German, etc., the Continental code may apply; but the Greek script cannot be expressed similarly. To communicate by means of our codes, the script must be transformed and expressed in a language for which that code is intended. Of course it is possible to express any character by a code letter, but where this is done, the code is no longer Internationally understood. This has been necessary in communication in Oriental languages, and the Japanese have developed such a code.

In the English, our characters are written according to the pronunciation and nature of the word, so that it is possible to take a new word made up of letters and pronounce it, even though we do not know what the writer word means. As the Oriental language is mostly monosyllabic, and a single syllable may mean a whole word, a written character means a whole word, or even may express a word with action. In making a character for a word, a symbol distinct and different would be used, making several hundred necessary if one were to express one's self by a scriptory message. The average Oriental possesses a vocabulary of several hundred characters, every one of which means something, and is memorized. Thus, if a message were written in such a language, it would be impossible to express it in the Continental code until it were translated.

It would be clearly possible to have a separate signal for every one of the several hundred characters, but such a code would be confusing, and would require years of effort to master.

When these people began telegraphic communication, the Japanese set about reducing these characters to the least number in which they, the Japanese, could express themselves from one to the other. They have now about fifty-five characters that have each a separate signal, these being exclusively of possible appendages. In this manner, a single character sent may mean either a sentence, single word or a large portion of a word consisting of several such characters.

It is true that these code units have been formed largely of Continental characters and appendages; but they stand for a different written result, and are a different code entirely.

Japanese operators are all educated above the average, and are encouraged to study the English language, so they can communicate by means of the Continental code and its languages, which perhaps confuses many who hear them near our ports. With us they are rarely free in working English, which, of course, measured by our standards, makes them somewhat misunderstood, but no operator who has sailed the Pacific can truthfully say they are not efficient in their own codes.

I have tried to show briefly why a different code is used by these people, and also that it is well used by them. In this I do not wish to portray them as plu-perfect, or create a fraternity, for brotherly love, for they have their faults as we all have. Some time our radio service may have to contend more severely with their work, in which case it would be well for us all to endeavor to understand them. This, though, is quite an impossible task, as my old friends Shaw, Johnstone, Baxter, and other old Pacific station operators, readily admit.

X. PERRY MENTER.

Valparaiso, Ind.

## RECTIFICATION.

Editor RADIO NEWS:

The Rocky Mountain Radio Association, Denver, Colorado, desires that you correct the article "A Clever Solution," appearing in your July issue, page 29, which implies that the Radio men of Denver have about bankrupt the Denver Gas & Electric Company by burning out transformers lights and causing fires. This Association has a letter from the Denver Gas & Electric Company which advises us that it is not so much the burned out transformers as it is the blinking of lights and the carrying down or short-circuiting of its lines, due to insecure aerial construction, and the breaking down of insulation in fixtures which may in turn cause fires. The company also advised us over the phone that they have not called H. H. Buckwalter into consultation at any time; he did, however, offer his services. The Rocky Mountain Radio Association suggests that those interested in Radio equipments in this section should call on or write to either of the following concerns whom we know to be fully posted and square in their dealings: The Wenner Radio Corporation, 1710 Glenarm Street, and the Reynolds Radio Company, Inc., 613 19th Street, Denver, Colorado.

This Association hopes that those who may read this will appreciate the great importance attached to the responsibility of an editor who is flooded with information from many sources which he is unable to verify before same is printed and it is hoped by us that the Radio Men throughout the country will bear this in mind in writing in, as by so doing we will assist in making the Radio profession one of the cleanest of businesses, and the information sent out can be fully relied upon.

ROCKY MOUNTAIN RADIO ASSOCIATION,  
GEO. W. MALER, Secretary,  
3914 West 29th St., Denver, Colo.



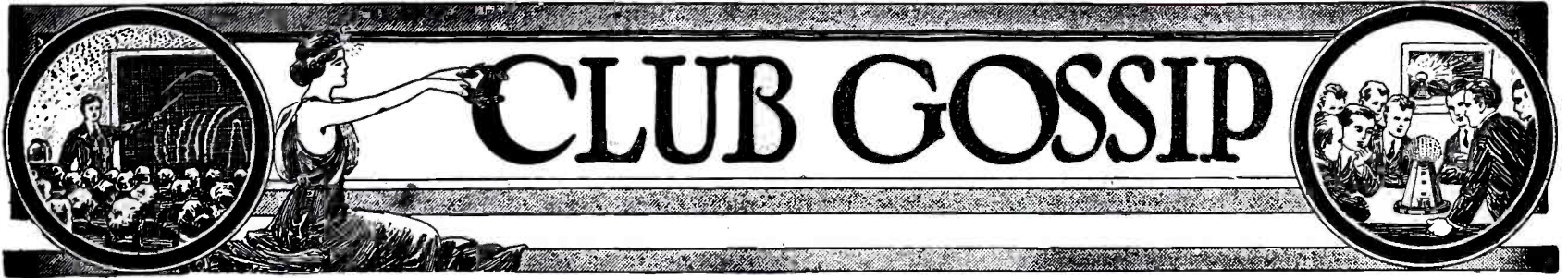

### THE RADIO CLUB OF BROOKLYN (N. Y.), INC.

On August 25th last, the members of the Radio Club of Brooklyn, Inc., enjoyed a moonlight sail followed by a lawn party on the grounds of the Baldwin Radio Manufacturing Co., at Sheepshead Bay, Brooklyn, N. Y.

Three boats were chartered for the sail, namely: *Porpoise II*, accommodating 35 persons; *Sunny Jim*, of the same capacity; and the Police Patrol boat under the command of Captain Goode, who, with Albert H. Rodde, Commander of the *Natant V*, was in charge of the Marine Flotilla.

The yacht *Natant V*, which has been equipped with Radiophone and 500-cycle 1/2-k.w. spark transmitter, acted as an escort to the outing. The flotilla was in touch with amateur land stations during the trip, directed by the shore station located on the grounds of the Baldwin Radio Manufacturing Co.

The course taken was out of Sheepshead Bay, around Manhattan Beach to Coney Island, out to Ambrose Channel, and back by way of the Rockaways to the grounds of the Baldwin Radio Manufacturing Co., at 10 P.M., where a jazz band awaited their arrival.

The grounds were electrically illuminated and profusely decorated with flags and bunting, Chinese lanterns and the club's colors, and could be seen for miles over the water.

The program for the evening was arranged as follows: The dancing was conducted by the Radio Club of Brooklyn, Inc., whose own orchestra supplied the music, and continued from 10 P.M. until 2 A.M. the following morning; during intervals refreshments were served and many interesting speeches were made by the leading radio men who were present.

The affair wound up with the band playing "Home Sweet Home."

The committees of arrangements were as follows: Albert H. Rodde, Marine; Harry Beirschank, Joseph LeClair, James Candido and Daniel Berlin, Reception Committee; Clinton Goode, C. F. Fink, Jack Phillips, Albert Lustig and Carmine J. Cagiano, Flotilla Committee.

### MILLER'S RIVER RADIO ASSOCIATION

The Miller's River Radio Association, of Athol and Orange, Massachusetts, wishes to introduce itself to the radio fraternity. This association, formed by enthusiasts of both towns, has twenty-two

members and expects to have fifty before the winter time.

The officers are: President, Wm. J. Kielar, commercial operator and graduate of Massachusetts Radio Institute; vice-president, Raymond L. Orrill; secretary-treasurer, William Wepler.

Meetings are held every Friday evening, temporarily in the Athol Y. M. C. A. It is hoped that permanent quarters will be secured soon where we can establish a station of our own. After the business meeting, classes are held for the instruction of the members.

An unusual feature of our association is that it is made up largely of men who know practically nothing about radio, having been formed by a few amateurs for the purpose of building up a local interest in wireless communication. We feel that we have been quite successful to date, as there are several new stations under construction.

Vice-president Orrill, 1ACY, of Orange, owns and operates a fine station and several members have listened in with him to radio concerts.

We have made arrangements with a local newspaper to conduct a column under the title of "Radiograms," and will in this way keep in touch with amateurs and those interested in radio in this locality.



This Picture Was Taken During a Party Given to its Members by the Radio Club of Brooklyn.

The association would be glad to receive communications from individuals and other radio clubs. Address the secretary, William Wepler, Athol, Mass.

### THE TOTEM RADIO CLUB OF SEATTLE

Seattle, Washington, has at last formed a radio club, after having been rather backward since the war, and the Totem Radio Club of Seattle is the name that was finally decided upon, after a great deal of discussion. The first meeting was called to order at 8 P.M. in the Social Service room of the Y. M. C. A. Committees were appointed to draw up a constitution, to decide on a suitable name and to secure a suitable meeting place.

Second and third meetings were devoted to ratifying constitution, election of officers, and securing members' names on the initial list, this list being of charter members; 35 members had station licenses, or amateur second grade, or better, while 18 who had a bona-fide interest in radio and had no licenses, or were out of town residents, were given associate membership (first named being full members). Officers elected were: President, Mr. Gale, of 7XK; vice-president, Mr. H. L. Jones; secretary, Mr. T. J. Bidner; treasurer, Mr. Edward Rebman, corresponding secretary, Mr. G. Ervin Kinsey, and publicity agent, Mr. Gifford Emery. At this meeting, a traffic committee and an executive committee were appointed from the list of active, working-station owners, and requested to get busy on their respective duties. Meetings are held every Saturday evening at 7.45 in the Chamber of Commerce rooms. We have a membership of 60 and want that many more, so come and bring a friend.

### NATIONAL UNITED RADIO TELEGRAPHERS' CONVENTION

At the second annual convention of the National United Radio Telegraphers' Association, held in New York City Aug. 15 to 18, the following officers were elected for the ensuing term: National President, Claude C. Levin; national 1st vice-president, H. L. LeCompte; national 2d vice-president, R. H. Murphy; National 3d vice-president, J. C. Mitchell, national secretary-treasurer, Alfred DeSilva, and eight members from the various districts to comprise the executive board.

## Dictionary of Technical Terms Used in Radio

**Royalty**—A license paid by a person to the patentee for privilege of manufacturing, selling or working a patented article.

**Ruhmkorff Coil**—See Induction Coil.

**Root-Mean-Square Value**—A periodic current which passes through a cycle of values has some one particular value called the instantaneous value at any moment. If we take the mean of the squares of the instantaneous values at equidistant intervals of time throughout the period, the square root of the mean of these values is called the root-mean-square value. In a current of simple sine form the R.M.S. value is equal to the maximum value multiplied by 0.707.

**Silver. Ag. Argentum**—Brilliant pure white metallic element. Hard, malleable ductile, and tenacious. A.W. 107.12. S.G. 10.474. Mlt. Pt. 1733°F. Val. 1. Chem. Tq. 107.12. Elec. Chem. Eq. 0.001, 118.1. S.R. Annealed 1.468, Hard drawn 1.620.

**Shock-Excitation**—A name given to the method of exciting oscillations by means of a quenched spark (see Quenched Spark).

**Spark**—An arc of short duration.

**Static**—Disturbances caused by atmospheric charging of the antenna. When it is definitely known that disturbances are due to atmospheric charging of the antenna, the

word "Static" shall be used. In general, disturbances shall be called "Strays."

**Strays**—Electromagnetic disturbances set up by distant discharges.

**Simple Cell**—A vessel containing several substances usually two metallic plates in a dilute acid, which by their chemical action produce a difference of potential between two suitably arranged connections. Portion of high potential plate outside liquid is called the Positive Pole and the other is Negative Pole. See Primary Cells.

**Sin**—See Sine.

**Sine**—Line drawn from one end of an arc perpendicular to a diameter drawn from other end of the arc. Is therefore equal to half chord of double the arc. Sine of triangle is given by perpendicular divided by hypotenuse.

**Sine Curve**—See Harmonic Curve. One in which the instantaneous value of the movement plotted is at all times equal to maximum value of the movement multiplied by the sine of the phase angle. A regular curve, having amplitude of each separate oscillation as high above zero as the trough is below.

**Sine of Angle**—Sine of arc measuring or contained in that angle, and is equal to Cosine of Complement.

**Sine Wave**—A wave having rhythmical changes, which can be represented by a Sine Curve or a smooth curve.

**Single-Fluid Cell**—A cell in which only one liquid is used.

**Single Phase Alternator**—One having its armature windings so arranged and interconnected that the various E.M.F.'s combine to give E.M.F. of machine as a single function of all the windings. Only two slip ring collectors are required.

**Single Touch**—Method of magnetising a bar of steel by gently rubbing it in one direction with one pole of a permanent magnet.

**Sinusoidal Wave**—See Sine Wave.

**Skin Effect**—The increased resistance of a conductor to high frequency currents to that offered to low-frequency ones is due to fact that high frequency currents confine themselves to the surface, or "skin" of the conductor, while the low frequency currents use the whole of the metal or "soak in." Also known as High-Frequency Resistance.

**Throw**—Of windings refers to width of coils of drum armature, also known as Pitch and Step.

**Tin**—Sn. Stannum. A.W. 118.1. S.G. 7.29. Mlt. Pt. 446°F. S.R. 13.048.





**T**HIS Department is conducted for the benefit of our Radio Experimenters. We shall be glad to answer here questions for the benefit of all, but we can only publish such matter of sufficient interest to all.

1. This Department cannot answer more than three questions for each correspondent.
2. Only one side of the sheet should be written upon; all matter should be typewritten or else written in ink. No attention paid to penciled matter.
3. Sketches, diagrams, etc., must be on separate sheets. This Department does not answer questions by mail free of charge.
4. Our Editors will be glad to answer any letter, at the rate of 25c for each question. If, however, questions entail considerable research work, intricate calculations, patent research, etc., a special charge will be made. Before we answer such questions, correspondents will be informed as to the price charge. You will do the Editor a personal favor if you make your letter as brief as possible.

### V.T. SUPPLIED WITH 32 V. D. C.

(259) Arthur O. Simpson, of Fish Creek, Wis., writes as follows:

Q. 1. Please publish the diagram of a detector using an "A" battery, potentiometer plate voltage control, filament and plate voltages to be secured from a 32-volt D.C. lighting pant.

A. 1. This hook-up appears on this page.

Q. 2. What capacity fuse should be used to protect the filament of a Cunningham detector V.T.?

A. 2. The fuse should have a maximum carrying capacity of one ampere.

Q. 3. Could the Radiophone messages be received with a set consisting of loading coils, loose coupler and V.T. detector?

A. 3. Yes, messages could be received with this set.

### RADIOTRON U.V. 200 V.S. "J" TUBE.

(260) Fenlon Quigley, of Des Moines, Iowa, asks:

Q. 1. Can a Radiotron U.V. 200 be used in place of a "J" tube in the C.W. set described by Mr. Arthur Lynch in the July issue of RADIO NEWS?

A. 1. Another make of tube may be used in this hook-up, but it should be a transmitting tube such as U.V. 202.

### WAVE-LENGTH INCREASE OF SHORT WAVE CIRCUIT.

(261) Fred Bortzmeyer, of Boulder, Colo., wants to know:

Q. 1. May a loading coil with 10 steps of about 400 M. each be used with the ordinary two-variometer, one-varicoupler set, with-out variable condensers?

A. 1. If you increase the wave-length of the primary, you should increase the wave-length of the secondary also, by shunting it and the grid variometer with a variable condenser, or by connecting a loading coil into the secondary circuit.

### USE OF INSULATORS IN GUY WIRES.

(262) Frederic Giebel, of Dallas, Texas, sends this request:

Q. 1. Please explain why insulators are used in the guy wires of an aerial.

A. 1. Insulators inserted in metallic guy wires supporting a mast are to prevent the guys from acting as aerials which may be in resonance with the sending antennae and absorb energy by cutting them into short lengths. Their natural period being very short, they do not absorb much of the energy radiated.

### EFFICIENT SET FOR LONG AND SHORT WAVES.

(263) J. W. Batts, of Miami, Fla., would very much appreciate answers to the following questions:

Q. 1. What do you think of the DeForest 15-panel unit set for all around work, for both long and short waves, or would you recommend another form of receiver.

A. 1. If properly tuned, a 15-panel set with honeycomb coil tuner is very efficient for all around work. By using various sizes of coils, any wave-length may be tuned in.

Q. 2. Where shall I apply for a license and a call number for my station.

A. 2. Apply to the Radio Inspector, Custom House, Savannah, Ga.

### V.T. SUPPLIED WITH A. C.

(264) F. I. Lester, of the Bronx, New York City, writes us as follows:

Q. 1. Please tell me through your "I-Want-to-Know" section how to use a step-down transformer to light a V.T.

A. 1. You will find this on page 447, January, 1921, issue of RADIO NEWS.

### MINIATURE VACUUM TUBES.

(265) A. C. Norwine, of Columbia, Mo., wants to know:

Q. 1. Where can I procure miniature vacuum tubes illustrated in Mr. Boucheron's article in the February, 1921, issue of RADIO NEWS.

A. 1. They are not manufactured in quantity. Only a few were made for experimenting and are not for sale as yet.

Q. 2. Is the enclosed hook-up correct?

A. 2. Yes. The size of the coil L depends upon the wave-length to be tuned in. L50 should be O.K.

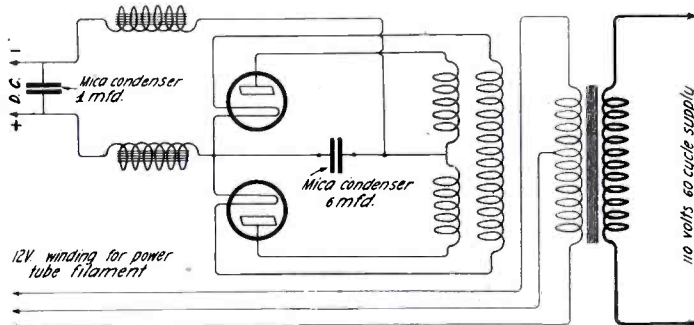

Complete Hook-up of a Power Transformer and Rectifier Tubes, for C.W. or Radiophone Transmitters. (Q. 271.)

### TICKLER COIL.

(266) E. Beaumont, of Bay City, Mich., would like us to publish the following information:

Q. 1. What size of wire should be used to connect the transmitting instruments, also what size for a crystal receiver and for a V.T.?

A. 1. In the H.T. circuit of a transmitter, the connections should be made with copper strips, or rather with stranded ribbon. In a receiving circuit some insulated No. 20 B & S wire is O.K.

Q. 2. Where can tickler coils be purchased of the correct inductance for honeycomb coils?

A. 2. The tickler coil itself is a honeycomb coil used as plate inductance in a regenerative circuit.

### RADIOPHONE MUSIC RECEPTION.

(267) G. K. Dabler, of Wyanet, Ill., sends the following inquiries:

Q. 1. Would I be able to receive Radiophone music with a single tube set, and over how great a distance can I receive it?

A. 1. Yes, you can, but we are unable to tell you the exact range, as this depends upon the aerial, the land surrounding your station, etc.

Q. 2. I know of two amateurs living near Chicago, who have tube sets, and cannot hear phone stations; one has a two-stage amplifier, the other a DeForest 15-panel set. They can hear signals all over the house, why can they not

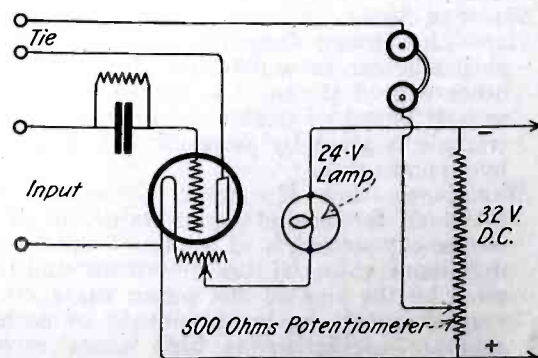

If a 32-V. D.C. Supply is at Hand, it May be Used for the Filament and Plate of a V.T. The Potentiometer Should Have a Resistance of Five Thousand Ohms. (Q. 259.)

hear phone stations?

A. 2. This is probably because they do not know how to tune their sets properly. Telephone reception requires a very sharp adjustment.

### CAGE AERIALS.

(268) Gerard J. Kohler, of Boston, Mass., wants to know:

Q. 1. Are cage aerials good for receiving and sending?

A. 1. Yes, they may be 5 in. in diameter, with four wires.

Q. 2. May a crystal detector be used with honeycomb or duolateral coils?

A. 2. Yes.

Q. 3. Kindly give hook-up of two-step amplifier with one "A" and one "B" battery for the three tubes.

A. 3. See Fig. 6 on page 100 of the August, 1921, issue of RADIO NEWS.

### GROUND.

(269) Arthur Hendricks, of Brooklyn, N. Y., asks the following questions:

Q. 1. Which is better for receiving, lateral coils or a regenerative set?

A. 1. This depends upon the wave-lengths to be received. For short waves, a regenerative set is very efficient and D.L. coils for all around work are more convenient.

Q. 2. Please give an efficient hook-up and describe the method of changing from audion to crystal reception?

A. 2. See page 796 of the May, 1921, issue of RADIO NEWS.

Q. 3. Would it be safe to use a pail of water on the fire-escape as a lightning ground?

A. 3. No; a real ground consisting of buried zinc plates or wires should be used.

### A LOOSE COUPLER IS O. K.

(270) A reader, of 84 Blake St., Buffalo, N. Y., wants to know:

Q. 1. Would a Turney spider web inductance used with a leading coil, when necessary, be better than a loose coupler for an amateur receiving set using a crystal detector?

A. 1. No, if you use a crystal, you do not need a three-coil mounting, a loose coupler is O.K.

Q. 2. Will a set receive wireless phone signals employing a crystal detector, variable condenser, 2,000 ohm phones and a loop antenna with either of the above pieces of apparatus?

A. 2. With a loop aerial a coupler is not necessary, but due to the rather poor sensibility of a crystal compared to a V.T., you should not expect good results unless the loop is of very large size and near enough to a phone station.

Q. 3. What crystal is the most sensitive, and can crystals be mounted in lead?

A. 3. Yes, crystal may be mounted in lead, but it is preferable to hold them in a clamp so that any face of the crystal may be used. A good combination is a galena with a fine platinum wire, or else Radiocite with a steel needle.

### ACME 200-WATT C.W. TRANSFORMER.

(271) Clifford Hansen, of Chicago, Ill., requests the following:

Q. 1. Please give a correct hook-up for use with an Acme 200-watt transformer and two DeForest rectifier bulbs, and the necessary chokes and condensers.

A. 1. This hook-up appears on this page.

### ARC SET.

(272) W. D. Meyers, of Vandergrift, Pa., has an arc transmitter of which he sends a hook-up and asks why he can't get any radiation with it.

A. 1. It is rather difficult to make an arc transmitter oscillate steadily on 200 meters, but if you wish to obtain better results we suggest that you try an oscillating circuit connected to the arc and coupled to the aerial.

See article on page 520 of the February, 1921, issue.



**ANNOUNCING**

# MURDOCK

**RECEIVERS**

## No. 56

*(Patented.—Other Patents Pending)*



**2000  
OHM COMPLETE  
DOUBLE SET  
\$5.00**

**3000  
OHM COMPLETE  
DOUBLE SET  
\$6.00**

The MURDOCK No. 56 Radio Receiver is a reproduction, with notable improvements, of the MURDOCK No. 55, which have deservedly earned a reputation of UNUSUAL SENSITIVENESS and LONG-LIVED DEPENDABILITY. Years of experience in production have so simplified our manufacturing processes that there is NOTHING QUITE SO GOOD AT SO LOW A COST. Every guarantee that has gone for the last 14 years with MURDOCK Radio Receivers is behind the MURDOCK No. 56.

Receivers encased in MURDOCK moulded insulation; magnet of best quality steel, embedded in case with pole pieces attached permanently and unchangeably; all receivers are by-polar; spools are wound with fine size pure copper wire with enamel coating, this method of winding ensuring a maximum number of effective layers; diaphragm is selected stock of thickness experimentally determined best; special attention is given to a most important feature of receiver efficiency, namely, the proper seating and clamping of the diaphragm; the cap or ear piece is MURDOCK moulded of size and shape best fitted for comfort and exclusion of outside noises; cords supplied with sets are five feet in length with durable mercerized finish. The headband wires are spring phosphor bronze and are covered with black-covered webbing. The design of the MURDOCK No. 56 Headband is unique because of the absence of screws on either Head Band or Receiver Adjusting Bale. The construction plan is the acme of firmness, strength, durability and service, all parts being riveted together.

### A WONDERFUL VALUE

2000 ohms .....	\$5.00
3000 ohms .....	6.00
1000 ohms Receiver only.....	1.75
1500 ohms Receiver only.....	2.25
Double Head Band.....	1.50

### GUARANTEE

Fourteen days' trial allowed in competition with any other receivers. If prior to, or at the expiration of the trial period, the receivers are not found to be completely satisfactory, the purchase price will be refunded upon return of the receivers.

**“PERFECT SATISFACTION GUARANTEED OR YOUR MONEY BACK”**

**BUY THEM FROM YOUR DEALER  
SEND FOR BULLETIN No. 21**

**WM. J. MURDOCK CO.** 50 CARTER STREET  
CHELSEA, MASS.  
509 MISSION STREET, SAN FRANCISCO, CALIF.



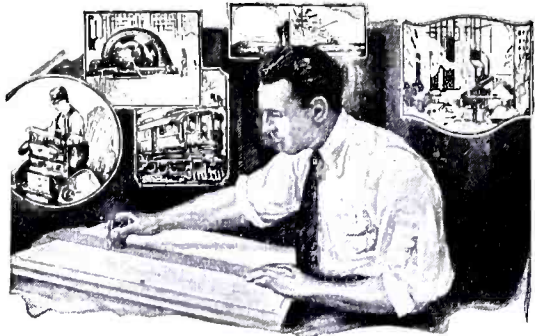

**WE'LL TRAIN YOU FREE**  
as Drafting Specialist  
**Earn \$35 to \$100 a Week**

After you have completed our Course in Drafting (mechanical drawing), we'll give you free training in your choice of one of our courses in a specialized branch of drafting.

**WHAT YOU GET FREE**

We also furnish you free with complete drawing and drafting equipment when you enroll for our Course. Free consultation privileges at any time, during your course or after you've taken your position. We help you to get a position as draftsman and send you free subscription to Draftsman's Publication, "The Compass."

**FREE BOOK**—Write today for free book, "Your Future in Drafting," giving details of our home study course in drafting and telling how you can qualify for a position paying \$35 to \$100 a week.

ROY C. CLAFLIN, President

**COLUMBIA SCHOOL OF DRAFTING**  
Dept. 1567, 14th and T Sts., N. W.,  
Washington, D. C.

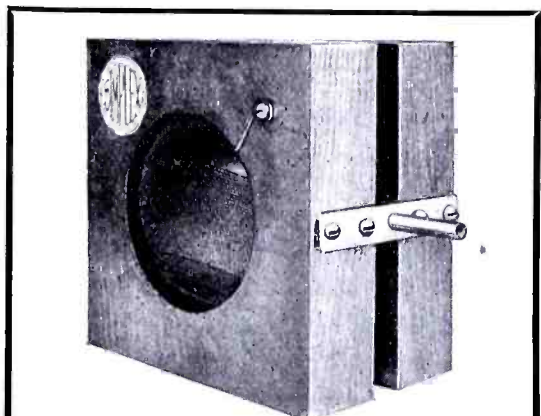

**Variometer**  
**Varlo-Coupler** Price \$6.00  
" \$6.00

Send for Bulletin No. 11-A describing these instruments and our unit panel sets. See them at your dealer. Discounts furnished to the trade.

**SIMPLEX RADIO COMPANY**

1013-15 Ridge Ave., Phila., Pa.

**NEW MOTORS** FOR ALL PURPOSES  
STANDARD MANUFACTURERS  
PROMPT DELIVERY

**ALL SIZES UP TO 5 H.P.**

**We Specialize In Small Motors & Generators**

ALL PHASES AND FREQUENCIES IN STOCK AT ALL TIMES  
Largest exclusive Mail Order Small Motor dealers in the world.

**CHAS. H. JOHNSTON, Box 13, West End, Pittsburgh, Pa.**

**WIRELESS, TELEPHONE GENERATORS**  
500 VOLT - 100 WATT - 3400 R. P. M.  
FOR MOUNTING MOTOR GENERATOR SETS.

**\$28 EACH**

WRITE FOR CATALOG

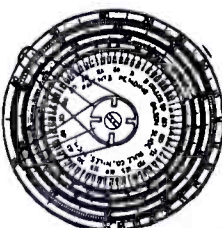

The Midget "FIVE-IN-ONE" Slide Rule is a combination Mannheim, Log-Log, Add and Subtract, Polyphase and Binary Slide Rule. It will instantly add, subtract, multiply and divide any combination involving whole numbers, fractions, decimals and mixed numbers. Gives every possible root and power of every quantity. The graduations are printed on metal coated with white celluloid and are grease and waterproof. While it is the most versatile calculator ever invented, its operation is simple and easily understood. Diameter 4"

Price with 16-page Instruction Book, \$1.50. Leatherette carrying case 50c extra. Catalog free. Your money back if you are not satisfied. Gilson Slide Rule Co., Niles, Mich

**Short Wave Regenerative Receiver**

(Continued from page 284)

The secondary and tertiary variometers have four turns per coil, two turns per layer and two layers. These finished coils are waxed to the dilecto forms, which have previously been machined to the required shape with considerable accuracy, as the forms should not rub during the 180-degree rotation and the face of the movable and fixed coils should be ten-thousandths of an inch apart. It will be found that these coils hold very nicely, if the dilecto is not oily.

The outside diameter of these coils is just four inches. Fig. 6 shows how to connect the four coils of one variometer so that they assist each other in the proper manner at all points on the scale.

Fig. 7 shows the construction of the grid condenser and by-passing condenser, both of which are fixed units. The grid condenser has four copper plates and five mica plates; the by-passing condenser has eight copper plates and nine mica plates, of sizes cut in accordance with the drawing.

Fig. 3 shows the interior of the receiver and gives a good idea as to how to assemble the complete unit. Heavy wire should be used for the wiring between units, No. 12 B. & S. bare copper wire, soft drawn, and covered with Black Empire cloth tubing makes a very neat job. An ordinary audion socket can be purchased and mounted on the front of the panel or behind a window as may be desired and will save the trouble of manufacturing a socket. The filament current rheostat is mounted in the rear of the panel, controlled by a knob and pointer at the front of the panel. A small key or push-switch is mounted to light the filament.

It is noted that the primary condenser-variometer unit is mounted vertically and the other secondary and tertiary units are horizontal. This is arranged in this way to prevent fixed coupling between the primary-secondary, primary-tertiary and secondary-tertiary circuits.

The operation of the receiver requires considerable care for best results. Assume that the receiver is ready for operation, the filament being light and the high potential battery being connected. Suppose that we wish to receive a station of unknown wavelength. Set the tertiary control at zero and set the coupling at about 70 degrees. Now work the primary and secondary control simultaneously, starting at zero and working toward 180 degrees. Provided signals are incoming, you will pass points where signals will be heard. Release the secondary control at one of the points and tune the primary control closely. Then turn the secondary control to that same wavelength. Now taking the tertiary control, bring that toward 180 degrees. As you move the tertiary circuits, it immediately starts regenerating and the signal strength will increase gradually. As the signal strength increases with the forward movement, it will finally increase to a point where the tone of the spark being received changes and becomes mushy. At that point the regeneration has reached a point which has caused oscillations to start.

If, while tuning to one incoming signal, you are being interfered with by a second, or third station, reduce the coupling toward zero, at the same time readjusting the primary and secondary controls. On reaching a point where the one desired station is being received, bring the tertiary control over starting regeneration, at the same time adjusting the coupling control and secondary control. Remember that when you reduce the coupling, you reduce the resistance in both the primary and secondary circuits, but at the same time reduce the amount of en-

**FREE!**

All Radio Operators should send for our

**Complete New Catalog Of Radio Apparatus**

*Just Off the Press!*

A carefully compiled catalog and guide to the best and most reliable radio apparatus; every article covered by our liberal guarantee; contains the LATEST REDUCED PRICES. Your copy is waiting—send for it TODAY.

**We Prepay All Express Charges**

"The Oldest Electrical House in America"

**JOS. M. ZAMOISKI CO.**  
19 N. Liberty St. Ask for Catalog M Baltimore, Md.

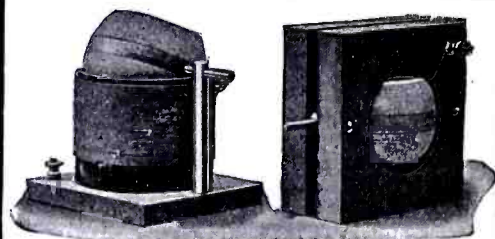

**Variometers \$3.75 each**  
**Couplers**

These instruments embody finest workmanship and best materials, all wooden parts genuine mahogany, coupler primary wound on formica tubing. Metal parts of brass. Wound for maximum results on short wave work. Will tune to 600 meters with small condenser. Shafts 3/16 inch. With Chelsea Dial and Knob \$1 extra. Send for bulletin describing unwired regenerators and other apparatus.

**FREDERICK WINKLER, JR.**  
304 Columbus Ave., New York City, N. Y.

The Most Sensitive Detector<sup>8</sup> Ever Produced

**AUDIOTRONS**

The original tubular vacuum Detector, Amplifier, Oscillator, Double filament Audiotrons.

**\$4.00**

ADD FOR PARCEL POST

**The Whitall Electric Co.**  
3 STEARNS PARK AVE.  
SPRINGFIELD MASS.

**STAMMER**

If you stammer attend no stammering school till you get my large FREE book entitled "STAMMERING, Its Origin and The Advanced Natural Method of Cure," bound in cloth and stamped in pure gold. Ask for special tuition rate and a FREE copy of "The Natural Speech Magazine." Largest, best-equipped and most successful school in the world for the cure of stammering, stuttering, etc. No sing-song or time beat. Write today. The North-Western School, 2366 Grand Ave., Milwaukee, Wis



# A NEW ERA IN CITIZEN WIRELESS HAS BEEN INAUGURATED BY

UNIVERSAL

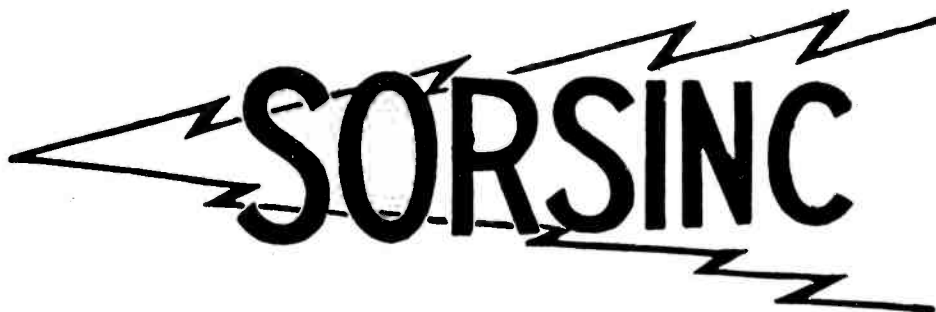

SERVICE

**SAVE ONE OR TWO WEEKS IN DELIVERY! MAIL YOUR ORDERS TO OUR NEAREST BRANCH STORE FOR PROMPT AND ACCURATE SERVICE.**

Our Branch Managers are the same men who for years have taken care of the Installation and Service of Commercial Apparatus on approximately 700 vessels. Each Manager is an ex-Amateur, and you will find him ready to assist you with your Radio problems.

*That Commercial Atmosphere will go far toward giving you a definite purpose and aiding you in your success.*

We are catering to you through the media of Expert Radio Men, and National and International Service.

AMPLIFYING TRANSFORMERS	
21A Saco Clad, shielded .....	\$ 5.00
A-2 Acme, semi-mounted .....	5.00
UV-712 Radio Corporation, shielded .....	7.00
226-W Federal .....	7.00

AUDION CONTROLS, AMPLIFIERS & REGENERATIVE RECEIVERS	
Grebe	
CR-8, New type, short wave regenerative, vario-meters, vernier, detector cir. ....	80.00
CR-9 New type, single circuit, 150 to 3000 meters, vernier, det. & 2 step. ....	130.00
RORD New type, detector & 2 step. ....	75.00
Westinghouse	
RA Regenerative 180-700 meters. ....	65.00
DA Detector & 2 step. ....	65.00
RC Tuner, detector & 2 step, in one cabinet, copper screened .....	125.00

DeForest	
MP-100 Audion Control .....	13.50
MP-200 First or 2nd step. ....	17.75
MT-100 Regenerative Tuner, short wave. ....	43.00

SOCKETS	
No. 30 Paragon, condensite base .....	1.00
No. 156 General Radio (for C.W.) .....	1.50
No. 92 Remler .....	1.50
R-500 DeForest, bakelite. ....	1.25
UR-542 Radio Corp., porcelain. ....	1.00

RHEOSTATS & POTENTIOMETERS	
90-P Shramco, 6 amps., for C.W. ....	2.00
No. 25 Paragon, moulded .....	1.50
PR-535 Rdo. Corp., for UV-200-1-2. ....	3.00
120A Fada, exceptional value .....	1.25
F-500 DeForest .....	1.65
PR-536 Radio Corp. A-Bat. Potentiometer. ....	2.00

JACKS & PLUGS	
1423-W Federal, 2 circuit jack. ....	1.00
1435-W Federal, filament control. ....	1.20
1438-W Federal, filament control. ....	0.50
1428-W Federal plug .....	2.00
No. 50 Pacent Universal plug. ....	2.00
34A. Firco "Bull Dog" flat plug. ....	2.00
34B Firco "Bull Dog" round plug. ....	2.50

TELEPHONES	
55 Murdock, 2000 ohms. ....	4.50
56 MURDOCK, 2000 ohms. ....	5.00
Brandes Superior, old type band. ....	7.00
Brandes Superior, new type band. ....	8.00
53-W Federal, 2200 ohms .....	8.00

VARIABLE CONDENSERS & DIALS	
Parts for DeF. CV-500, .0005. ....	\$ 3.00
Parts for DeF. CV-1003, .001. ....	4.75
Parts for DeF. CV-1503, .0015. ....	5.05
Murdock & Chelsea cond. and dials. ....	

CRYSTAL DETECTOR	
101A Fada, enclosed type .....	2.50

LOUD SPEAKERS	
22A Firco Vocaloud, station type. ....	30.00

**USE THE**

**SORSINC**

Net Weight 12 Lbs.		22½ Volts
Shipping Weight 14 Lbs.		Price at our U. S. Offices \$4.00

**"THE LARGEST B-KNOWN"**  
Rated Capacity 6400 Milliampere Hours. Shelf life: Guaranteed not to depreciate more than 10% in voltage in six months.  
FOR RECEPTION AND TRANSMISSION.

The new R. C. A. C.W. Instruction Book mailed to you for 25 cents. Enclose 4 cents to cover mailing.  
**ORDER ANY STANDARD MAKES OF APPARATUS OR PARTS AT REGULAR LIST PRICES.**

**DEALERS:**  
We Are Jobbing All The Important Lines.  
Write to Our Nearest Office for Our Proposition.

METERS	
303 R-S Special 0-2.5 amps. ....	\$ 5.75
127A Gen'l Radio. 100 M-A .....	9.00
UM-530 Radio Corp. 0-2.5 amps. ....	6.00
UM-533 Radio Corp. 0-5 amps. ....	6.25

C.W. POWER TRANSFORMERS	
50 Watt Acme, mounted .....	15.00
200 Watt Acme, mounted .....	20.00
UP-1368 Radio Corp. 325 Watt. ....	25.00
315-W Federal. 500 Watt. ....	50.00

MODULATION TRANSFORMERS	
A-3 Acme, semi-mounted .....	5.00
UP-414 Radio Corp. ....	7.25

VACUUM TUBES & ACCESSORIES	
UV-200 RCA Detector tube .....	5.00
UV-201 RCA Amplifier tube .....	6.50
UV-202 RCA 5 Watt Trans. tube. ....	8.00
RCA Grid Leaks, all sizes .....	.75
RCA Grid Leak Mounting .....	.50
UC-567. (568, 569, 570) Tubular Grid & Plate Condensers, Radio Corp. .00025. ....	1.20
UC-568 .0005. ....	1.35
UC-569 .001. ....	1.50
UC-570 .0025. ....	2.00

C.W. SPECIALS	
260-W Federal Hand Microfone. ....	7.00
HM-100 DeForest Hand Microfone. ....	6.00
300-W Federal Filter Coil 800 M-A. ....	7.50
311-W Federal Filament Trans. 200 Watt. ....	15.00
150 M-A Acme Single Choke Coll. ....	4.00
500 M-A Acme Single Choke Coll. ....	6.00
75 Watt Acme Filament Trans. mounted. ....	12.00
150 Watt Acme Filament Trans. mounted. ....	16.00
OT-3 DeForest Radiofone .....	100.00
OT-5 DeForest Radiofone .....	135.00
Type 0 DeForest Radiofone .....	260.00
UP-415 Radio Corp. Plate Reactor. ....	5.75
UC-1631 Radio Corp. Filter Cond. ¼ mfd. ....	1.35
UC-1632 Radio Corp. Filter Cond. 1 mfd. ....	1.85
UP-1719 Radio Corp. 5000 ohm grid leak. ....	1.10
UP-1718 Radio Corp. 5000 ohm grid leak. ....	1.65
PX-1638 Radio Corp. Rotary Grid Chopper. ....	7.25
UC-1015 Radio Corp. Series Condenser, 7500 V. .0003, .0004, .0005 mfd. ....	5.40
UC-1014 Radio Corp. Plate & Grid Cond., 3000 V., .002 mfd. ....	2.00
UV-216 Kenotron Rectifier .....	7.50

**SHIP OWNERS RADIO SERVICE, INC., 80 WASHINGTON ST., N. Y. C.**

**BRANCH OFFICE STORES:**

PHILADELPHIA .....	2006 Columbia Ave.
BALTIMORE .....	403 Lobe Building.
NORFOLK .....	26 Haddington Building.
SAVANNAH .....	230 Broughton St., East
NEW ORLEANS .....	710 Maison Blanche Annex
PORTLAND, ORE. ....	622 Worcester Building.
HONOLULU .....	408 Boston Building.

**BRANCH OFFICES:**

BOSTON .....	175 Commercial Street.
GALVESTON .....	313 American Natl. Ins. Building
SAN PEDRO .....	432 Palos Verdes Street
SAN FRANCISCO .....	24 California Street.
SEATTLE .....	3451 East Marginal Way.
LONDON .....	15 City Chambers, 65 Fenchurch St., E. C.



# BUY IT from THE NAVY

Surplus Navy Radio Materials  
**FOR SALE**  
At Attractive Prices

## RECEIVING SETS

suitable for receiving ship, amateur, or long wave signals.

## SPARK TRANSMITTERS

complete with motor generators or gas engine driven generators.

## ACCESSORIES

(except Vacuum Tubes)

of every description suitable for experimental or research purposes.

This is an **EXCELLENT OPPORTUNITY** for Colleges, Radio Schools and Amateurs to buy **NAVY—R-A-D-I-O—Equipment** at **ATTRACTIVE PRICES.**

Write today for

Navy Radio Catalogue No. 601-71

The surplus materials the Navy has available for sale have been grouped as shown below and catalogues describing these materials will be sent on your request.

### LIST OF SURPLUS MATERIALS

- All Materials.
- Aeronautical Equipment.
- Aluminum.
- Bath Room Fittings and Plumbing Supplies.
- Blankets.
- Boats.
- Books.
- Brass.
- Canvas and Tents.
- Chemicals.
- Cloth and Textiles.
- Clothing.
- Copper.
- Electrical Equipment and Supplies.
- Furniture.
- Hardware.
- Iron.
- Lead.
- Machinery.
- Mess and Galley Equipment.
- (Kitchen and Dining Room.)
- Monel.
- Musical Instruments.
- Navigating Instruments of Precision.
- Oils and Greases.
- Paint and Paint Materials.
- Provisions.
- Radio Equipment.
- Rope and Twine.
- Stationery and Office Equipment.
- Steel.
- Tin.
- Tools, Hand, Machine and Contractors'.
- Valves and Fittings.
- Zinc.

## CENTRAL SALES OFFICE

Navy Dept. Washington, D. C.

ergy being transferred. There is a point when maximum signal strength will be obtained for all stations and it will never be at 90 degrees for weak signal when the receiver is properly tuned.

Wireless telephone signals are received just the same as spark signals or other damped types of oscillations. However, in-

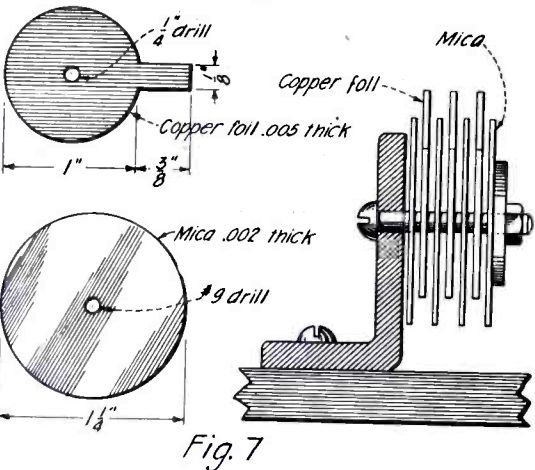
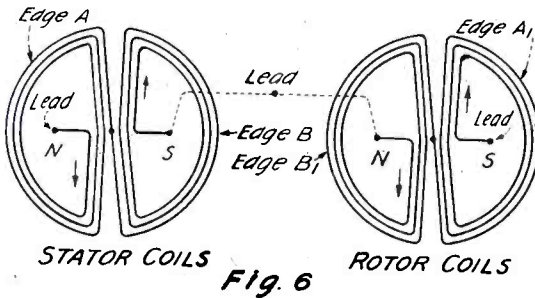

Fig. 6 Shows the Connections of the Coils in the Variometer. In Fig. 7 Are the Details of Construction of the Small Fixed Condenser.

asmuch as this receiver is capable of starting oscillations in itself, it can be used to receive continuous or undamped oscillations as well, on wave-lengths of 150 to 750 meters.

The tuning is similar to tuning in spark signals, only the tertiary control must al-

(Continued on page 326)

## A Common Cause of Induction from the Ship's Dynamo and Its Remedy

(Continued from page 286)

opposite sides connected to the main ground, as in Fig. 1.

(2) Connecting the filament line of the detector and amplifiers to the "receiving ground."

In the case of the single circuit receiver, the latter would be unnecessary as the filament is already grounded, but when an inductively coupled receiver is used the filament should be connected to the receiving ground to completely eliminate induction.

### A SIMPLE AND PRACTICAL "BREAK-IN" SYSTEM THUS DEVELOPED

Another and exceedingly useful phenomenon which made itself evident as the result of this use of a separate receiving ground was that strong signals could be obtained with one side of the receiver primary connected to the main ground and the other to the receiving ground, or, in other words, with the aerial change-over switch in the "transmitting" position (where, as is usual, the switch is connected to ground). An excellent "break-in" system was thereby obtained.

It must be common knowledge to operators of Navy sets, where the change-over switch is connected to the ground, that it is possible to receive signals with the switch in transmitting position or "receive through the ground" as it is commonly called, but this was only possible when the transmitting

## ANNOUNCING The Crosley Variable Condenser

(Pat. Pend.)

"BETTER—COSTS LESS"

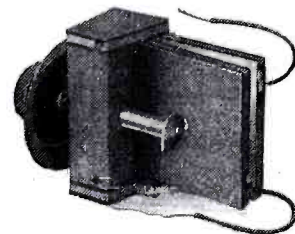

This Condenser works on an entirely new principle. The two plates are hinged and are opened and closed like a book by means of a specially designed cam. The plates are surfaced with copper. One copper sheet is covered with mica so that when the two plates are clamped tightly together the maximum capacity is obtained. The maximum capacity of this Condenser will average about .0008. We rate it conservatively, however, at .0005.

This Condenser has several advantages over the ordinary type of air condenser. Will stand 1000 volts without breaking down. It can therefore be used for C.W. work. Has no body or hand capacity effect. Has much greater signal strength due to the fact that mica is a much more efficient dielectric than air. The calibration curve of this Condenser is almost a straight line. Has unusually low zero capacity—.00006.

Price without knob and dial.....\$1.25  
With knob and dial..... 1.75  
Mounted in cabinet with knob and dial..... 2.50

Sold on a **GUARANTEE** of absolute satisfaction or money refunded.

## CROSLEY CRYSTAL RECEIVER

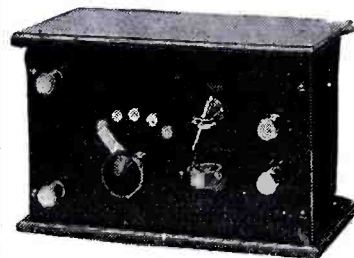

No batteries, tubes, etc., required. Hook it to your aerial and phones. It will tune from two hundred to six hundred meters, bringing in spark, voice, and music, with an average

amateur aerial. Complete with battery and interrupter for crystal testing, crystal, etc. Price \$7.00. Phones extra.

DEALERS: This will help you get 'em started.

## Crosley Cabinets

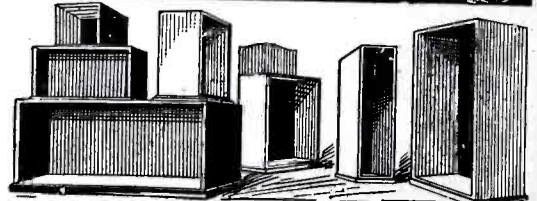

The tendency in the radio field today is to put apparatus in cabinets not only for appearance's sake, but as a protection from dust, dirt, atmospheric conditions, etc. Realizing the demand for attractive stock cabinets of various sizes, we are building them in quantities in our large wood working plant. These cabinets are all uniform in style. The panels are rabbeted in to the front. As the outside dimensions and inside dimensions are either larger or smaller than the panel itself, we show panel size and also inside dimensions. Prices quoted do not include the panels.

All cabinets are waxed antique mahogany finish. Wood used is either gum, genuine solid mahogany or quartered oak. Lids or tops are hinged. Sizes and prices are shown below:

For Panel Size	CABINETS Inside Dimensions			Mahogany or Quarters Oak	
	High	Wide	Deep	Gum	Oak
6x7	6 1/2"	7"	7"	\$2.50	\$3.55
6x10 1/2	8 1/2"	10"	7"	2.75	4.40
6x14	8 1/2"	15 1/2"	7"	3.50	5.55
6x21	8 1/2"	20 1/2"	7"	3.90	7.30
9x14	11 1/2"	15 1/2"	10"	3.70	6.80
12x14	11 1/2"	18 1/2"	10"	4.40	6.80
12x21	11 1/2"	20 1/2"	10"	5.25	10.60

Cash must accompany order. No C.O.D.'s. We pay transportation charges.

We can furnish genuine formica panels 3/16" thick, cut to the following dimensions: 6x7; 6x10 1/2; 7x9; 6x14; 7x12; 6x21; 7x13; 9x14; 12x14; 14x18; 18x21. Price of panels—3/4¢ per square inch. For odd sizes order the next largest size; we will trim. We pay postage.

Every article bearing the name "CROSLEY" is **GUARANTEED** to give absolute satisfaction or money will be refunded.

We shall be pleased to send literature describing the above mentioned and other radio apparatus to any one free of charge upon request. Get your name on our mailing list to receive latest Bulletin of other new Crosley products. If your dealer does not handle our goods, order direct and send us his name.

DEALERS—It will pay you to handle our line. Write for full particulars.

CROSLEY MANUFACTURING CO.

Radio Dept. No. R-4B CINCINNATI, OHIO



# CROSLEY V-T SOCKET

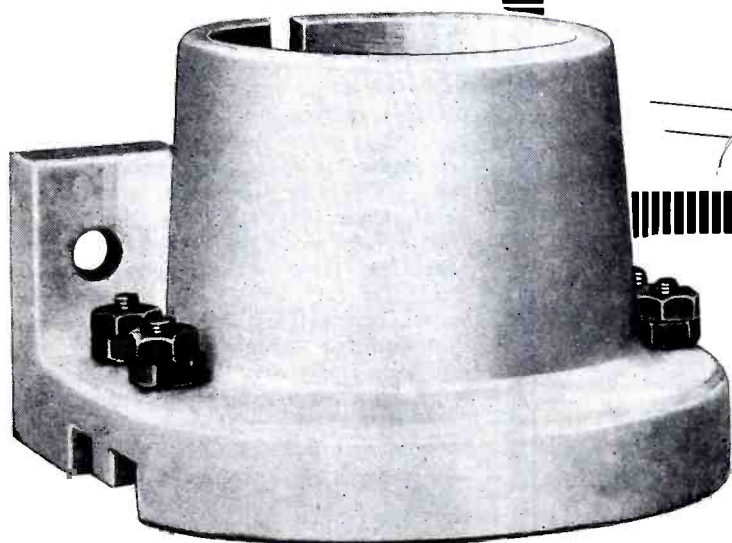

**PRICE**

**60¢**

*Better—  
Costs Less*

**T**HERE must be good reasons for its instant popularity—why it was the hit of the Chicago Radio Show—why today it is the best seller.

It's the only socket made for both base and panel mounting. It's made in one piece, entirely of porcelain—there is no metal shell—hence no "ground hum." Its design eliminates possibility of short circuiting filament across high voltage "B" Battery. It is better—and costs only 60 cents.

Be sure to use CROSLEY SOCKETS in the radio set you are building. Every live dealer handles them—if yours doesn't, send us his name and order direct—we will ship prepaid.

**DEALERS:** *It's worth your while to investigate the CROSLEY line.*

## Crosley Manufacturing Company

Radio Dept. R-4A

Cincinnati

Ohio



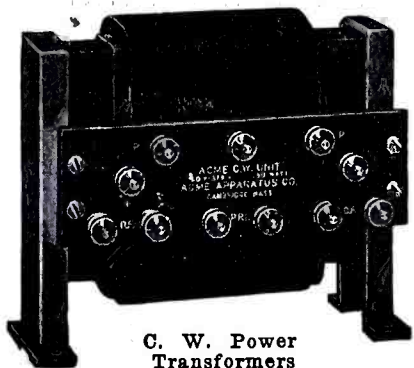

C. W. Power Transformers

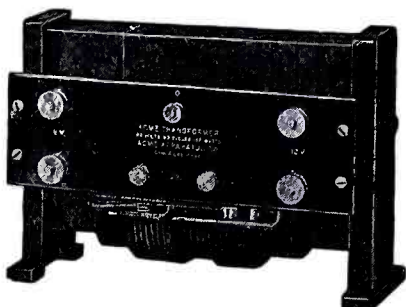

Filament Heating Transformer

## BEFORE BUYING C. W. APPARATUS

### Ask for ACME BULLETINS

Anyone having an alternating current supply can have a telephone and telegraph station.

No storage batteries or motor generator required.

Filaments lighted by transformer.

Plate voltage and current supplied by transformers.

High voltage direct current is easily obtained by rectifying alternating current and smoothing out by means of choke coils and condensers.

No moving parts to require attention.

No noise.

### ACME has the Most Complete Line of C. W. APPARATUS

#### C. W. INDUCTANCE

C. W. Power Transformers

Filament Heating Transformers

Choke Coils

Amplifiers

C. W. Plate Transformers

Modulation Transformers

Amplifying Transformers

Detectors

#### THE APPARATUS WITH THE GUARANTEE

**Acme Apparatus Co.,** 188 Massachusetts Ave. Cambridge 39, Mass.

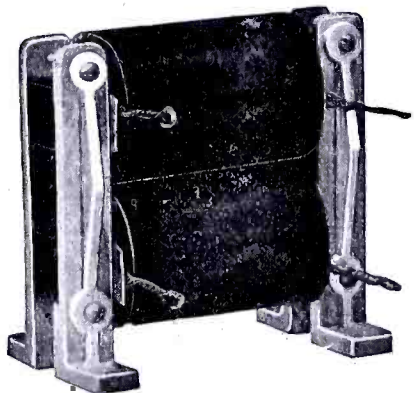

1 1/2 Henry Choke Coil

*Transformer and Radio Engineers and Manufacturers*

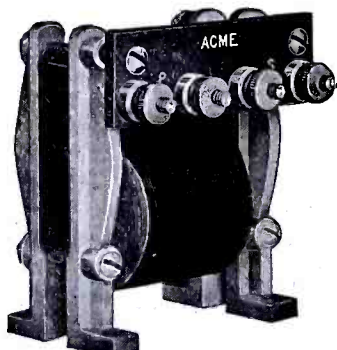

Amplifying Transformer

station was not too far away and signals were very weak. The reason for this reception of signals will be understood by a consideration of the diagrams of Fig. 2.

In Fig. 2A, a part of the functions of the Aerial Change-over switch is illustrated. L is the secondary of the oscillation transformer and L1 the Aerial Tuning Inductance of the transmitting circuit, while L2 and C constitute the primary of the receiver. Now when the change-over switch is placed in the transmitting position the circuit of Fig. 2B results. Weak signals may be obtained by tuning at L2 and C, but if, see Fig. 2C, the primary of the receiver is connected to a separate ground, as used to eliminate induction, the signals are increased many times and are only slightly less than when the receiver primary is alone connected directly to the aerial (i. e., with the change-over switch in the receiving position).

It is, of course, necessary to tune the receiver to a lower wave-length as the transmitter A.T.I. acts as a loading coil in the receiving circuit. It should be remembered that any variation of the secondary of the oscillation transformer or of the A.T.I. of the transmitter, as takes place when transmitting on different wave-lengths, correspondingly varies the wave-length of the receiver. It is necessary, also, to note that good contact be made at the A.T.I.

It is not possible to use this method of receiving with wave-lengths much longer than the one to which the transmitter is tuned, but this is immaterial, as it is only intended for "break-in" purposes.

The signals are, of course, not quite so loud as with the receiver alone connected directly to the aerial, but with amplification they are loud enough for most purposes and the slight decrease in signal strength is more than compensated by the usefulness of the "break-in" when handling traffic. It is only necessary to pull the change-over switch and make suitable alterations at the receiver primary to change from one method of receiving to the other.

The only disadvantage we found to this method of receiving was that, the receiver primary being again connected to the main ground, a certain amount of induction was obtained. This was very slight, however, and almost negligible. We had intended to experiment with three separate ground connections, one for the transmitter, another for the receiver and the third for the leads covering the lines, the protective devices, transmitter panel or any other likely source of induction.

The change-over switch would be connected to the first ground, the filament to the second and the condensers of Fig. 1 to the third ground. But we "came out on strike" last May and did not finish our experiments. It is possible that by this means the "break-in" could be utilized without any induction whatsoever.

## "MIRACO"

### REGENERATIVE RECEIVER

**\$39.50**  
PREPAID

The new MIRACO Short Wave Regenerative Receiving Set is complete with Detector and all necessary controls in the same cabinet. Responds to spark and C-W and is ideal for wireless phone reception.

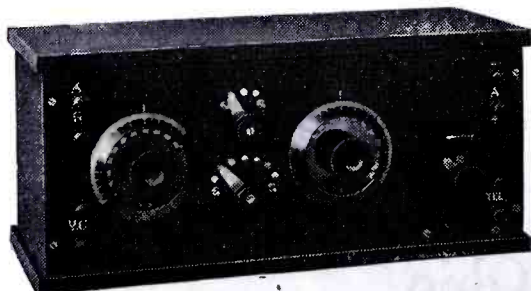

ARE YOU ON OUR MAILING LIST OM? SEND TO-DAY FOR OUR FREE CATALOGUE.

**MIDWEST RADIO CO.,** 3423 Dury Ave., Dept. A, CINCINNATI, OHIO.  
"EVERYTHING FOR THE RADIOMAN"

### DX Reception Without Antenna or Ground

(Continued from Page 285.)

Those used by myself were of the following dimensions: the stators had an inside diameter of 4 1/2" and were wound with 30 turns for each half, or 60 turns for both sides, of No. 18 D.C.C. wire, while the rotor consisted of a wooden ball 4" outside diameter wound with 60 turns of the same wire. In the set I constructed, the coupler was placed between the two variometers. The grid condenser and leak unit were of .00019 mfd. capacity, with .5 megohm leak, and is sold on the market today in a complete unit. The detector and two-stage amplifier may be of any make, but the one used in this case was an RORF.

One of the important things that I discovered with the above combinations is,



# "ATLANTIC RADIO" OCTOBER BULLETIN



## SACO CLAD (FIRTH) AUDIO FREQUENCY TRANSFORMERS

are light in weight, small in size, and eliminate howling or tube noises. The continuous wall and core of laminated silicon steel ensures 100% magnetic efficiency. Throughout the 360 degrees the magnetic flux must pass through a perfect magnetic medium. This continuous wall of 3/16" laminated steel also serves as a perfect magnetic shield for the windings with the result that howling or squealing are absolutely eliminated. Recently a six stage amplifier was built using the SACO CLAD transformer with unbelievable results. There was an absolute lack of noise other than the incoming signals. SACO CLADS are easy to mount on any flat surface—two 3/16" holes are all that are necessary. Use SACO CLADS in your next two-stage amplifier unit. You will be surprised!

Price, In Individual Cartons, \$5.00 Including Postage on 1 pound

No Battery Required **FIRCO VOCALLOUD** No Accessories Necessary

RADIO STATIONS equipped with the FIRCO VOCALLOUD in conjunction with suitable receiving apparatus will deliver radio telegraph and telephone signals capable of reception, in many cases, hundreds of feet from the instruments.

Through adopting the famous Baldwin amplifying movement to the electro-magnetic reproducer, maximum diafram vibration is obtained without employing an expensive and troublesome storage battery. The long permanent magnet actuates the special mica diafram by its action upon the balanced armature. The action is exactly similar to that in phonograph reproduction which accounts for the perfect manner in which the Vocaloud renders radio phone concerts.

MADE IN TWO TYPES  
Station Type, Complete, \$30.00  
Laboratory Type, Complete, 25.00

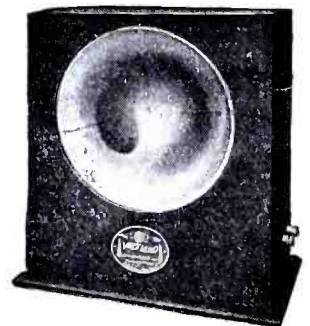

STATION TYPE

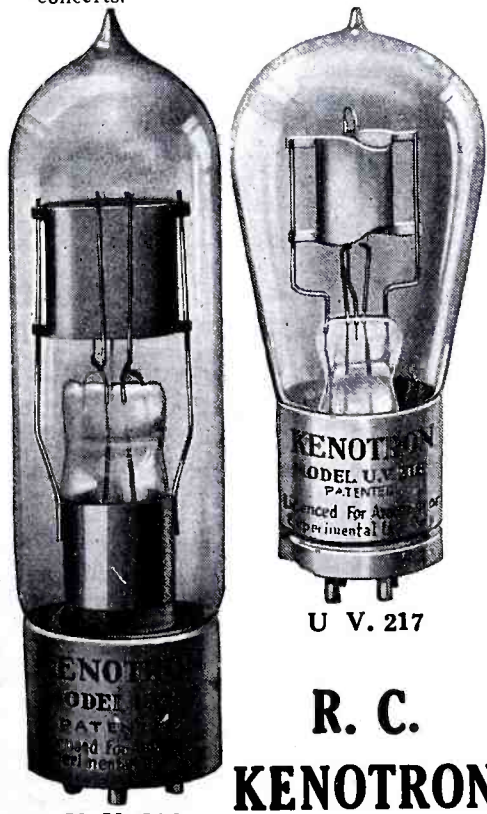

**R. C. KENOTRON**

U. V. 216

**RECTIFIER**

U. V. 216, 20 watt, for use with Radiotron U. V. 202, \$7.50

U. V. 217, 150 watt, for use with Radiotron U. V. 203, \$26.50

## PARTS FOR C. W. SET

Operating directly from 110 V. A. C. Approximate range, 400-500 miles. Conservative range, 250 miles.

- 1 "Acme" 200 Watt Power Transformer.....\$20.00
- 2 Radiotron UV202 5 Watt Transmitting Tubes ..... 16.00
- 2 "General Radio" Tube Sockets ..... 3.00
- 1 "National" Rheostat, 3 ohm, 6.5A ..... 5.50
- 1 "Tuska" 3-Circuit inductance ..... 12.50
- 3 Condensers ..... 3.00
- 1 Grid Leak 10,000 ohms 1.25
- 1 C. W. Key ..... 3.00
- 1 "Radiotron" Meter, 0-2.5A., T.A.W..... 5.00
- 1 B.D. Panel for meter (with pole and binding posts) ..... 1.50
- 1 Wood Base (Stained). 1.50

Complete Set of Parts, Ready to Assemble, **\$72.25**

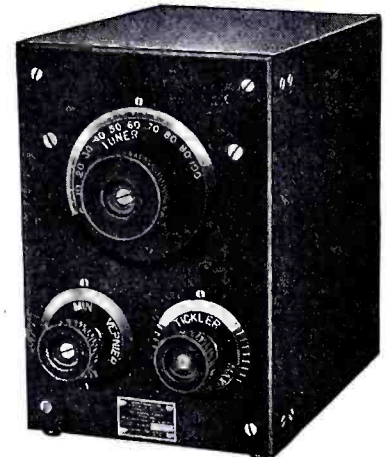

## WESTINGHOUSE RADIO EQUIPMENT

Westinghouse Radio Equipment embodies the latest ideas in receiving equipment, providing a most efficient set for telegraph and telephone reception over the amateur and normal ship wave-length ranges.

- Type R. A. Short Wave tuner, Style 307189, responds to a wave-length of 180 to 700 meters and is especially selective. Type D. A. detector-amplifier, Style 307190, combines a vacuum tube detector with a two-stage amplifier. Both units are mounted on Micarta panels attached to a polished mahogany cabinet. Simple in design—easy to operate—single-tuning circuit. Highly efficient.
- Type R. A. Tuner.....\$65.00
- Type D. A. Detector Amplifier.. 65.00
- Type R. C. (Combination of above mounted in single cabinet)....125.00

Ask for Special Westinghouse Literature

# ATLANTIC RADIO COMPANY, Inc.

727 Boylston Street  
Boston 9, Mass.

REQUEST "BULLETIN 14"

Branch: 15 Temple St.  
Portland, Me.

Please include sufficient postage with all mail orders.



# ANNOUNCEMENT

Greater Boston amateurs are cordially invited to visit our new salesrooms at 178 Washington Street, near Adams Square, Bos-

ton. A Somerville radio reply postcard will be given FREE to each visitor.

Get acquainted with our snappy service and up-to-date stock!



**Type JK HAND MICROPHONE \$6.00**

Used in some of the most prominent amateur stations. Has six-foot mercurized cord and moulded rubber handle. Metal parts are heavily nickel plated and buffed. An extra large microphone button, with polished carbon faces and large granules is the secret of efficiency.

Type JK Microphone (without cord and handle) \$2.00.



The New AMRAD line receives our enthusiastic endorsement! Send for New Amrad Bulletins, or better still, order at once from their advertisements. Remember, we pay postage on all orders in the first five zones!

Wimco CW Inductance, 25 turns, assembled.....\$10.00

Wimco CW Inductance, 50 turns, assembled.....\$13.50

Complete set of parts for 25 turn inductance.....\$8.50

Complete set of parts for 50 turn inductance.....\$12.00

The WIMCO INDUCTANCE is made entirely of sheet Formica, ruggedly and accurately assembled, and will safely carry input currents up to, and including 100 watts. Five positive contact clips are provided. The 25 turn inductance is suitable for 200 meter work.

## A Superfine Indicator of Highest Quality With Every Desirable Feature. Insist Upon, SOMERVILLE DIAL INDICATORS

When ordering material for your next set, 4" silverplated and lacquered dial clockwise rotation and calibration space, electro-chemical engraving. Genuine BAKELITE knob of correct size. The knob is an example of master moulding; 2 1/4" at flange, 1 1/2" at knurl and may be bought separately for 85c without setscrew or 90c with setscrew.

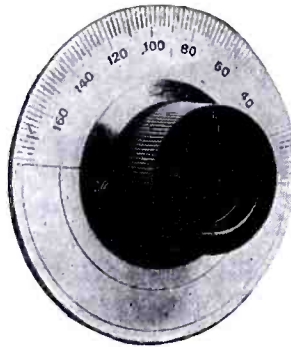

PRICE \$2 postpaid or from your Dealer.

### MODULATION TRANSFORMER, \$5.00

Designed for the RADOTRON U.V. 202 and will safely carry the grid current of two 5 watt tubes, using 1/4 amp. in the primary. The resistance of the primary is 1.7 ohms, and the secondary, 2700 ohms.

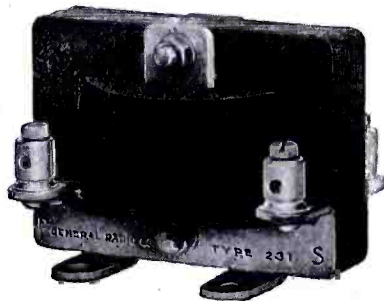
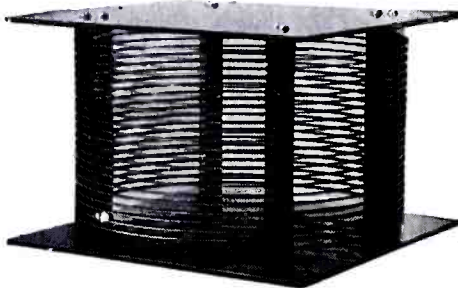

**SOMERVILLE RADIO LABORATORY, Sales Office, 178 Washington St, BOSTON, MASS.**

## WIRELESS

You should have it even if only superficially interested. Around about you every day you read of some marvelous occurrence in which wireless played a distinguished part. It may not be entirely clear to you. The Manual will explain it. To the student of Wireless Telegraphy, the Manual contains much that is indispensable to a proper understanding of the art.

It contains 200 pages, fully illustrating and describing the many instruments used in Radio. 45 pages cover general instructions, diagrams, station calls, tables, codes and other information.

The book is printed on highly finished paper with a two-color cover and measures 9 x 5 1/2 inches.



## MANUAL M12

Containing as it does a fund of valuable information not generally contained in a catalogue, it approaches nearer a text book in the fascinating field of wireless telegraphy. No expense has been spared to make it accurate and reliable.

No Wireless Experimenter Should be Without the Mesco Wireless Manual. We ask 25 cents (25c) for it—give you a coupon receipt which can be applied on any future order.

Send your name and address now, and get one of the most complete, comprehensive and reliable wireless books published.

### MANHATTAN ELECTRICAL SUPPLY CO. INC.

17 Park Place  
New York

114 S. Wells St.  
Chicago

1106 Pine St.  
St. Louis

604 Mission St.  
San Francisco

Get a Handy Binder for your RADIO NEWS. Holds and preserves twelve issues, each of which can be inserted or removed at will. Price 65c. Experimenter Pub. Co., Inc., Book Dept., 286-A Fulton St., New York.

that it works best below the surface of the ground. The deeper down the more QSA the signals. I started by trying it at a height of 50' above the ground, but with poor results, only nearby stations being recorded. As the height was cut down and the set approached nearer the level of the ground, signals increased rapidly in strength, the greatest signal strength being obtained below the surface of the ground.

In my case the depth was 10' and with the above mentioned set amateurs were copied a distance of 500 miles. In the basement below the ground, therefore, seems to be the best place for receiving apparatus, from my experience.

The only adjustments necessary are that the set be brought up to the proper point of oscillation, by means of the variometers, and then the coupling varied for finer regeneration. Very critical adjustment is necessary when tuning the variometers, otherwise the station will be passed over unobserved.

Be careful of body effect while tuning in weak signals, as it is sometimes hard to bring in clear signals except by keeping the body perfectly stationary.

There is no critical adjustment necessary with detector and two-stage amplifier, and the same plate potential is used as under ordinary receiving conditions.

The above described set will not only respond on amateur wave-lengths, but on any wave-length up to 13,400 meters. Whether the longer wave-lengths are forced oscillations from high powered stations or not remains to be found out, but, nevertheless, they have been logged.

Of the numerous stations recorded, the following are some at the greatest distance: 8OZ, 8RQ, 8AGK, 8JL, 8BC, NSF. Besides these, I heard the following on higher wave-lengths, NSF, KUVS, NDD.

## The Production of Continuous Oscillations in Circuits Which Contain Capacities of High Value

(Continued from page 291)

capacity of the circuit. Both circuits involve amplification of the timing potentials on the grid, which liberate energy in the anode circuit of the valve acting as a generator. When the capacity of the shunt condenser is large, the potentials across the oscillatory circuit are small, and, if communicated in correct phase to the grid, would be too weak to produce self-oscillation. These potentials are, therefore, first amplified by one or more three-electrode valves until they are strong enough to maintain the oscillations.

In Fig. 1, the oscillatory circuit is shown as  $L_1 C_1$  included in the anode circuit of  $V_1$ , the battery H supplying the anode current. Any momentary oscillation in  $L_1 C_1$  is induced into  $L_2$ , a coil of high resistance. The potentials across  $L_2$  are communicated to the grid  $G_2$  of  $V_2$ , and amplified in the anode circuit  $A_2 R_1 H F_2$  of the second valve  $V_2$ . This anode circuit contains a resistance  $R_1$  having a value of about 70,000 ohms (which will be of the same order as the resistance of the filament-to-anode path of  $V_2$ ). Magnified high-frequency potentials will be produced across  $R_1$ . The valve  $V_2$  consequently acts practically as an aperiodic amplifier of all frequencies. The potentials across  $R_1$  are now passed to the grid  $G_1$  of  $V_1$ , and if the coil  $L_2$  be connected the right way round, will maintain the oscillations in the circuit  $L_1 C_1$ . The condenser  $C_2$  is merely used to prevent the high potential of the anode battery H from



# CONTINENTAL NEWS

OCTOBER, 1921

PUBLISHED EVERY MONTH IN RADIO NEWS BY THE CONTINENTAL RADIO AND ELECTRIC CORPORATION

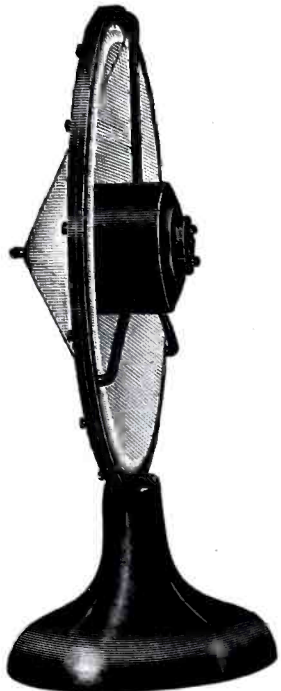

## The PHONETRON Electric Sound Converter

### More Than a Loud Speaker!

Designed for both reception and wireless telephone transmission in place of a microphone transmitter.

Price \$45.00

Send for FREE descriptive leaflet about Phonetron, the improved type of loud speaker.

### Order by mail from New York's leading Radio Store

It's a lucky thing for a good many radio stores, that amateurs are willing to blame the mails when they have to wait for their goods. You can order from Continental with the assurance that you won't have to wait. You can bank on it that your order will start toward you the day we get it. Everything listed in our catalogue is right here in stock—no delays. And there isn't much worth having, in radio, that isn't listed in the CRECO catalogue. It's not out of place to say that the Continental mail order stock includes worth-while apparatus for every part of your station. No matter what wireless equipment you need, you can be sure that Continental has it, or will get it for you quicker than you could get it yourself.

Send your next order to Continental. No matter how large or small, it will be filled promptly, courteously, carefully. Please make all remittances by bank draft or Post Office Money Order, to avoid any possible delay.

## PARAGON scores again

The hearty endorsement of Paragon R. A. Ten by leading amateurs speaks for itself. Last month we printed 2ZL's enthusiastic letter. This month we have selected this similar statement from 2ZM as representing the opinions of hundreds of amateurs who have been astonished and delighted with the results they have secured. This is the letter:

"Wish to acknowledge receipt of my Paragon in good shape.

"At the same time, I wish to say that I have gotten some surprising results having read a number of DX stations that were never heard before, with my other receivers, even in the winter time.

"I can truthfully say that the Paragon gives better results for all around amateur work than any receiver I have ever used, and will highly recommend it to my fellow amateurs."

(Signed)

L. SPANGENBERG,  
Radio 2ZM.

### Ask your Radio Dealer

to show you a Paragon R. A. Ten regenerative receiver. If he hasn't one in stock, he will gladly get one if you ask him for it. The seals have now been broken to show you the splendid inside construction. Examine a Paragon carefully—convince yourself that these leading amateurs have not overstated one particle in their complete approval of Paragon results,—and that Paragon is well worth its \$85.00 price.



## CRECO AMPLIFYING TRANSFORMER

High in Quality—Low in Price

\$3.25

In keeping with the Continental policy of distributing only apparatus of the highest quality at a reasonable price, we offer this instrument of utmost mechanical and electrical efficiency. It was developed specially to fulfill the requirements of present day VTs. Sold complete, ready for mounting. Important features are:

- Unequalled audibility and amplification.
- No holes in core, eliminating magnetic leakage.
- No castings used, etc., etc.

Such a simple, but efficient instrument should interest you, at any price. But at the price of only \$3.25 (far lower than any other transformer) you will have to act quickly. Send for enough Creco transformers for all your VTs at once. We cannot guarantee to keep the production up to the demand.

DEALERS Write for Proposition.

**Honolulu**  
comes to  
**Continental**  
(read this letter)  
Today I am sending you a radio again for some wireless supplies.  
You are getting me delivery in fifteen days from the day I cable you, and that is some service to the center of the Pacific.  
(Signed) CYRIL O. SMITH.  
Permanent address, The Royal School, Honolulu, U. S. A.  
**OUR SERVICE COVERS THE WORLD**

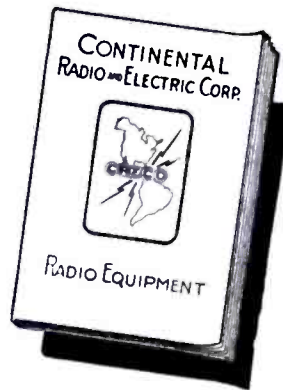

### DO YOU STILL OWN A QUARTER?

If so, and if you haven't already sent for the Creco catalogue, that's the best way to invest it. 112 pages for a quarter, chock full of illustrations, descriptions, prices, and all the radio apparatus you ever heard of. Also codes, abbreviations, tables, etc., that you will use daily. Be a sport. Risk a quarter on the best radio buy ever offered you! Anyway, you get credit for your quarter on your first \$5.00 order, so you really get the catalogue for nothing. Your copy is all ready to be mailed. Slip your name and your quarter into an envelope now!

# CONTINENTAL RADIO AND ELECTRIC CORP.

EXCLUSIVE WHOLESALE DISTRIBUTORS FOR  
PHONETRON AND PARAGON R. A. TEN

J. DI BLASI, Sec.

J. STANTLEY, Treas.

Dept. E-59 6 Warren St. New York City



# RADISCO BETTER "B" BATTERIES

No batteries at the price are as good! No batteries at any price are better! Every Radisco Better "B" Battery is an investment in satisfaction. Small size, \$1.50. Large size, (with seven variable voltages) \$2.65. At all Radisco agencies and other reliable dealers.

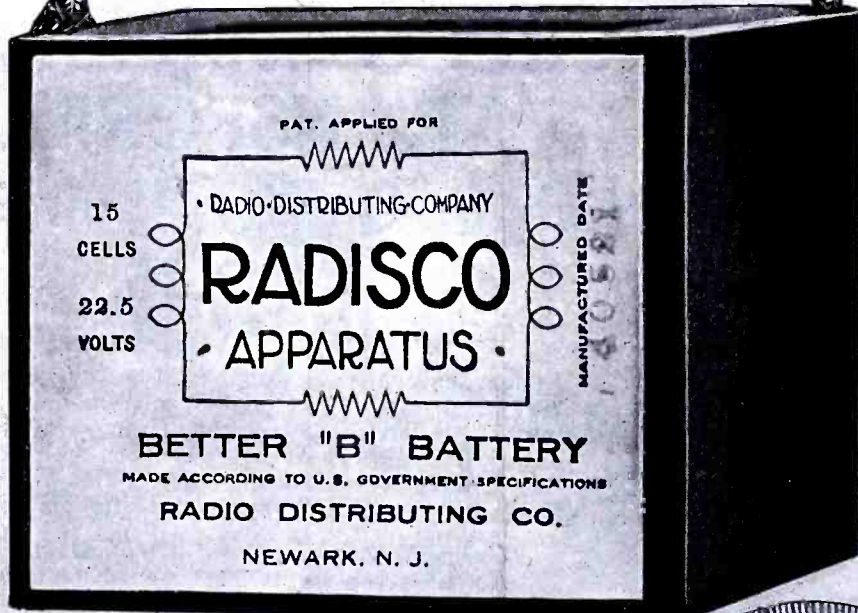

# RA "Your Ass"



### Corwin Dials

At the new prices, there is no longer any reason for getting along without genuine Corwin Dials. 3 in. Dial, 60c, with knob, \$1.00; 3 1/8 in. Dial, 80c, with knob, \$1.20.

## THESE RADISCO AGENTS ARE GOOD DEALERS

ALBANY, N. Y.  
Shotton Radio Mfg. Co.  
8 Market St.

ASHEVILLE, N. C.  
Hi-Grade Wireless Instrument Co.

ATLANTIC CITY, N. J.  
Paramount Radio Supply  
Arkansas & Pacific Aves.

BOSTON, MASS.  
Atlantic Radio Co.  
727 Boylston St.

BROOKLYN, N. Y.  
Kelly & Phillips  
312 Flatbush Ave.

EUREKA, ILL.  
Klaus Radio Co.

KANSAS CITY, MO.  
McCreary Radio Supply  
4th and Delaware Sts.

McKEESPORT, PA.  
K & L Electric Co.  
427 Olive St.

NEWARK, N. J.  
A. H. Corwin & Co.  
4 West Park St.

NEW ORLEANS, LA.  
Rose Radio Supply  
604 Gravier St.

OMAHA, NEBRASKA.  
O. B. Radio Supply Co.  
406 Brown Building.

NEW BRUNSWICK, N. J.  
Geo. N. DeLaplaine  
306 George St. and  
8th and Magnolia Sts.

PHILADELPHIA, PENN.  
Philadelphia School of  
Wireless Telegraphy  
1533 Pine St.

PITTSBURGH, PENN.  
Radio Electric Co.  
3807 Fifth Ave.

PLAINFIELD, N. J.  
Paul R. Collier,  
154 E. Front St.

PORTLAND, ME.  
Atlantic Radio Co.  
15 Temple St.

PROVIDENCE, R. I.  
Rhode Island Electrical  
Equipment Co.  
45 Washington St.

SCRANTON, PENN.  
Shotton Radio Mfg. Co.  
P. O. Box 3  
Branch 8, Kingsbury St  
Jamestown, N. Y.

SEATTLE, WASH.  
Northwest Radio Service  
609 Fourth Ave.

WASHINGTON, D. C.  
Eastern Radio and Elec.  
Co., 1405 Florida Ave.  
N. W.

### Improved Corwin Switch

Same material, quality, and price as Corwin Dials. All metal heavily nickel-plated. Phosphor blade. Smooth operation. Contact contacts. Neat appearance. 90c.

Canadian  
MONTREAL, QUEBEC.

J. B. Miller  
136 Vendome Ave.,  
N. D. G.

TORONTO, ONTARIO.  
The Vimy Supply Co.  
567 College Street.



# RADISCO

## Assurance of Satisfactory Performance"

**A** valuable feature that you never pay for, but always get, in Radisco apparatus, is the "Assurance of Satisfactory Performance." Only work well done deserves the name of its maker as a mark of pride. Every time the word "Radisco" appears on a radio instrument it represents a design known to be correct, a standard of quality scrupulously maintained, and a price that clearly shows the savings of modern quantity production. And every time you buy any Radisco instrument, we

risk all the reputation that years of "Satisfactory Performance" have built up, on whether that one purchase fully satisfies you.

Buy your radio apparatus for this season now, while dealers can give you more careful attention and better choice than later. Radisco dealers all over the country have complete stocks of new Radisco instruments. Go to the nearest Radisco agent listed below and share in the "Assurance" that thousands of satisfied Radisco customers now enjoy.

RADIO DISTRIBUTING COMPANY, 4 West Park Street, NEWARK, NEW JERSEY

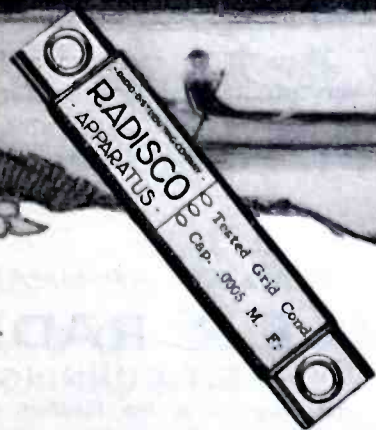

**Radisco Grid Condenser**

An example of high efficiency in the least possible space. Tested capacity .0005 Mfd. Priced at only 35c.

**Grid Leak Condenser**

Same construction, supplied with grid leak, for only 50c.

**Phone Bridging Condenser**

Also of similar style and quality for only 35c.



**ous Radisco Coils**

Provided in sizes to receive all known wave-lengths. Mounted or unmounted. Larger sizes provided with three taps for variable ranges. Standardize on Radisco Coils and be sure of results.

This Mark  Your Guarantee



# REMLER

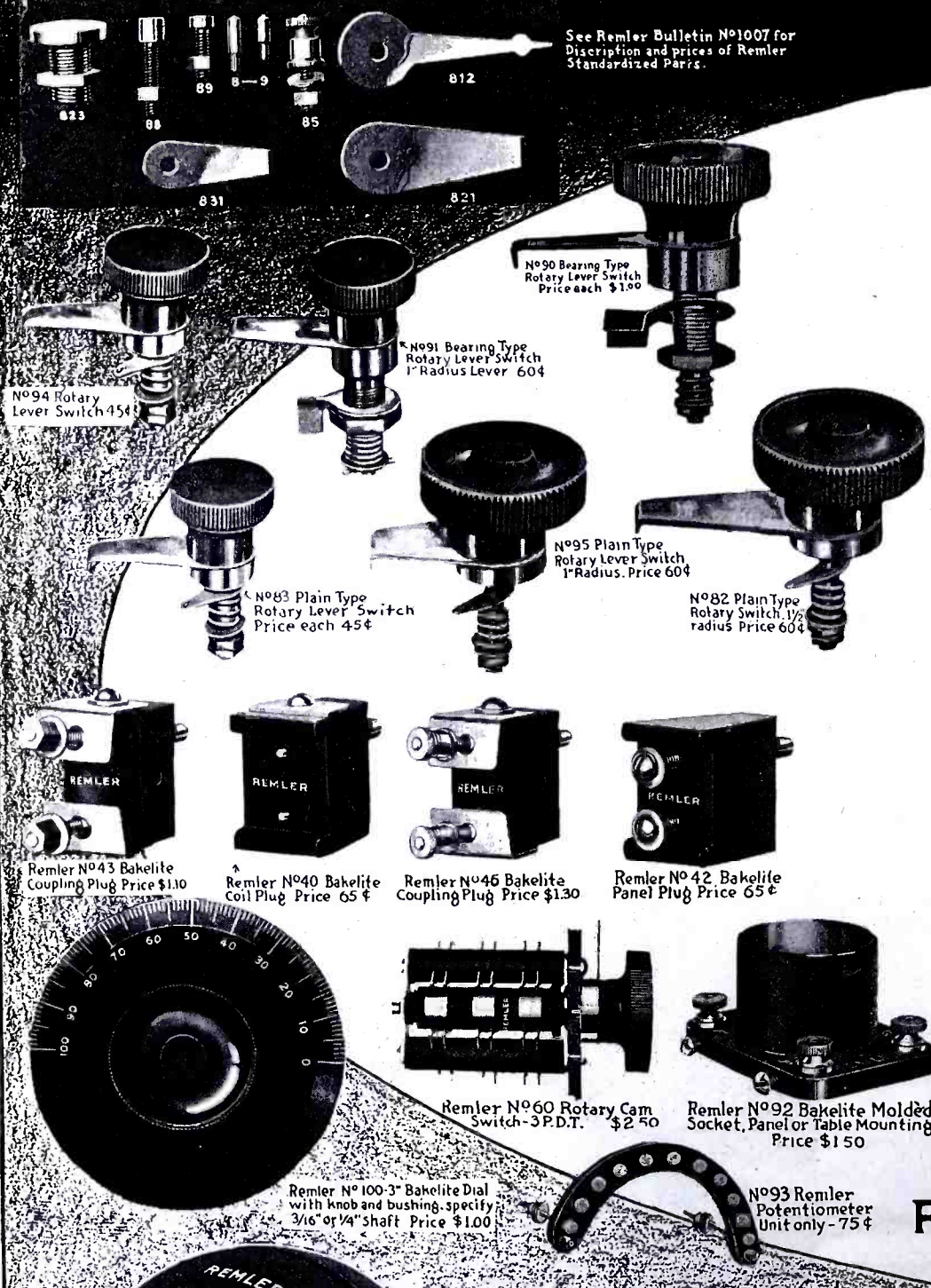

## RADIO

THE Remler items shown on these two pages give some idea of the scope of Remler Radio Apparatus.

Dealers throughout the country are stocking up on Remler Apparatus—they have felt the demand for this quality merchandise.

The amateur is keen to observe its superior quality in materials and workmanship.

Every dealer should consider these factors when purchasing Radio Apparatus—insist on Remler—the Radio Apparatus that Radiates Quality.

### DEALERS:

There is an exclusive and very profitable proposition for you on Remler Apparatus. Write for full particulars.

REMLER APPARATUS  
**REMLER RADIO**  
 E.T. CUNNINGHAM

163 Sutter Street, San Francisco, Cal.





# REMLER

## APPARATUS

**R**EMLER RADIO APPARATUS is designed and built to meet the requirements of the exacting amateur.

Every Remler item is studied, designed, and built to serve the exacting tests of the amateur radio field. Quality in its manufacture means the solution of hundreds of intricate problems in dozens of processes.

The Remler organization is made up of men who know the radio field—who have been pioneers in their line. These men are today building the finest Amateur Radio Apparatus in America—Remler.

### AMATEURS:

Write for 32-page Remler Bulletin just off the press.

**RADIATES QUALITY  
M'FG COMPANY  
GENERAL MANAGER**

154 West Lake Street, Chicago, Illinois.

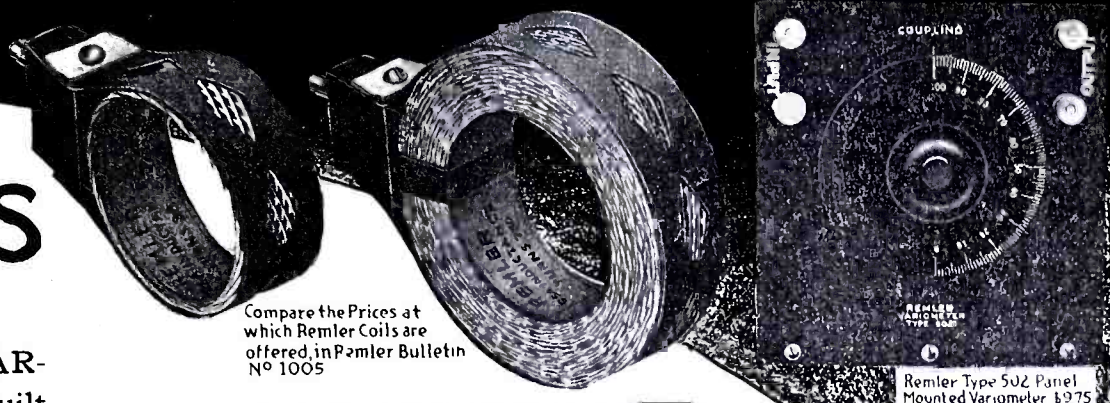

Compare the Prices at which Remler Coils are offered, in Remler Bulletin No 1005

Remler Type 502 Panel Mounted Variometer \$9.75



Remler No 44 Extension Handle 35¢



Remler No 10 Polished Bakelite Knob Price each 20¢

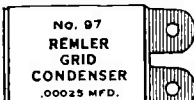

Remler No 97 Fixed Grid Condenser 35¢

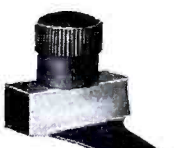

Remler No 96 Variable Grid Leak 60¢

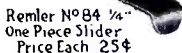

Remler No 84 1/4" One Piece Slider Price Each 25¢



N.P. Washers Center Hole lapped 1/32" Diameter 3/4" Depth 3/16" Each 15¢



Remler No 41 Bakelite Coil Mounting Price 80¢  
Remler No 45-14" Waterproof Fiberoid Strap Price 15¢

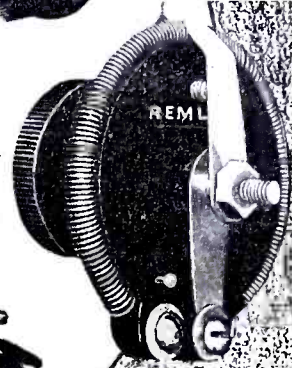

No 813 Remler Panel Type Rheostat 3 amp. capacity \$1.75  
No 811 1/2 amp. capacity \$1.75

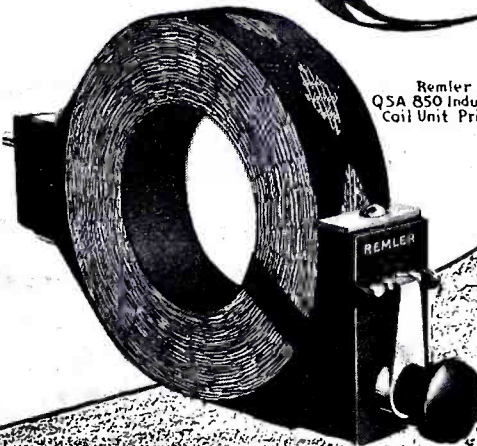

Remler QSA 850 Inductance Coil Unit Price \$6.00

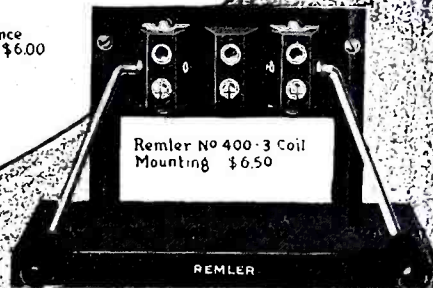

Remler No 400-3 Coil Mounting \$6.50

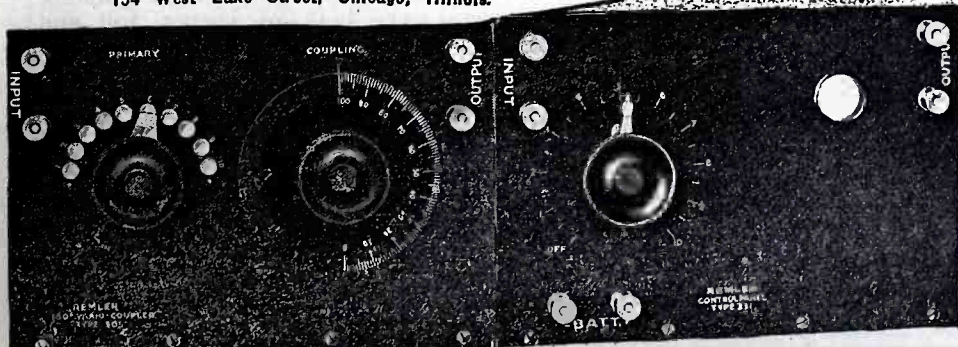

Remler Type 505 Panel Mounted 180° Vario-Coupler \$12.75

Remler Type 331 Amplifier Panel (Less Transformer) \$6.00

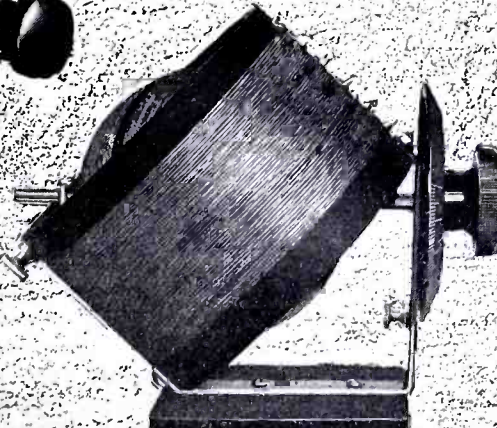

Remler Type 503 180° Vario-Coupler \$5.40  
Type 504 with No 100 Bakelite Dial and Knob \$6.40



# RADIO SERVICE

## Apparatus of Merit

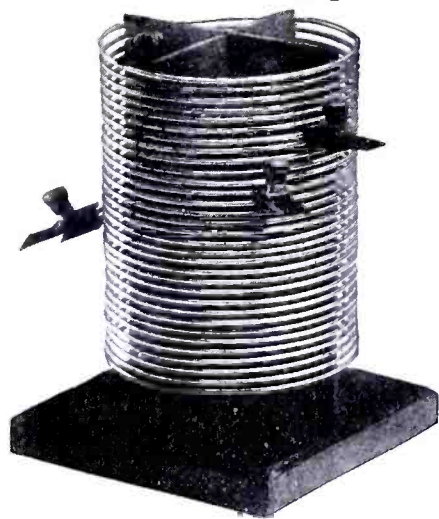

A real efficient inductance, wound on a slotted Formica form, 4½" diameter of 31 turns of Number 10 hard drawn copper wire. Supplied with 3 special clips making adjustments variable to any fraction of a turn. Suitable for panel or bench mountings. Materials and workmanship the finest obtainable.

Type S50 Inductance, price.....\$8.50

C.W. Mica Grid Condenser, mounted (stands 1,800 volts)..... 1.00  
C. W. Navy Type Filament Control Rheostat ..... 2.00

### Lower Prices on V. T. Sockets.

Type S10 Single Socket.....\$ .90  
Type S3 Double Socket..... 2.25  
Type S4 Triple Socket..... 3.25

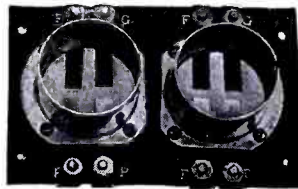

Radio Service sockets have hard drawn aluminum shells, machined bakelite bases, heavy phosphor bronze contact springs, and metal parts nickel plated.

### RADIO SERVICE SMALL PARTS

Type S15—.0005 Grid Condenser.....35c  
Type S18—.00025 Grid Condenser.....35c  
Type S16—.002 Receiving Cond.....35c  
Type S30—Combination Grid-leak Condenser .....50c  
Type S26—Nickel Binding Post.....12c  
Type S17—Nickel Crystal Cup.....25c  
Type S21—Super-sensitive mounted Galena Crystal .....50c  
Type S28—3 in. Metal Dial, dull black finish .....30c

Six grid leaks for the price of one  
Type S40 leak 0 to 3 megohm in ½ megohm steps, bakelite mounted and moisture proof, for only 75c.

### THE SENSATION OF RADIO

THE LITTLE WONDER PORTABLE RADIO SET, that you saw in the "movies, the daily papers, etc. Simple to install and operate. Just connect your aerial, ground and phones and you are ready to receive wireless telegraph or telephone messages and music.

A truly wonderful set within the reach of all. Over 1,000 of these sets are in service and all giving complete satisfaction.

Type S8 (as illustrated), Price.....\$7.50  
Type S8 with Murdock 2000 ohm headset.....11.50  
Type S8A complete (incl. 75 ohm phone, aerial, insulators, blue print and instruction book).....12.50  
Type S8B complete, but with Murdock 2000 ohm double headset .....15.50

Radio Service Apparatus may be obtained at all reliable dealers or sent direct to you on receipt of price



## RADIO SERVICE & MFG. CO.

SALES DIVISION  
110 WEST 40th ST., NEW YORK CITY

FACTORY  
LYNBROOK, L. I.

### SPECIAL PRICE REDUCTIONS

Paragon Control Panel with U.V. 200 Radiotron Tube .....\$10.50  
Audiotron Tube Two-Filaments ..... 5.50  
Radiotron Detector Tube with a combination Grid Leak Condenser ..... 5.00  
Radiotron Amplifying Tube with a combination Grid Leak Condenser ..... 6.50  
No. 55 Murdock 2000 OHM Wireless Head Sets ..... 4.00  
No. 56 Murdock 2000 OHM Wireless Head Sets .....\$4.50  
No. 55 Murdock 3000 OHM Wireless Head Sets ..... 5.00  
No. 56 Murdock 3000 OHM Wireless Head Sets ..... 5.50

ACE OR CYCLONE WIRELESS B. BATTERIES  
22½ Volt. Small ..... .98  
22½ Volt. Large ..... 1.75  
22½ Volt. Large Eveready Variable B. Battery, New Type ..... 2.75  
45 Volt Variable B. Battery ..... 3.00

The above Prices are F.O.B. New York

HYGRADE ELECTRICAL NOVELTY CO.

### MARKO STORAGE BATTERIES

6 Volt 20 to 40 Amp. ....\$12.50  
6 Volt 40 to 60 Amp. Ford Type..... 15.00  
6 Volt 40 to 60 Amp., Large Type ..... 16.00  
6 Volt 60 to 80 Amp. Ford Type ..... 18.50  
6 Volt 60 to 80 Amp. Large Type ..... 20.00  
6 Volt 40 Amp. U. S. Battery ..... 10.00  
6 Volt 60 Amp. U. S. Battery ..... 13.75  
.0005 M.F. Grid Condensers ..... .25  
.002 M.F. Phone Condensers..... .25  
Variable Grid Leak Condensers ½ to 3 Megohms .65  
Binding Posts, Nickel Plated .. Per Dozen .80  
Binding Posts Rubber Cap..... Per Dozen 1.00  
Switch Points Nickel Plated, Small, Per Dozen .35  
Switch Points Nickel Plated, Large, Per Dozen .45

We Guarantee every order shipped within 12 hours.

41 WEST 125th ST., NEW YORK

influencing the grid G<sub>1</sub>. The leak R<sub>2</sub> (of about two megohms resistance) keeps the grid G<sub>1</sub> at a suitable normal potential.

The second arrangement (Fig. 2) works on exactly the same principle. There is, however, now only one main oscillatory circuit L<sub>1</sub> C<sub>1</sub>, no coupling coil being used. The middle tapping of L<sub>1</sub> is connected through H to the filament of the first valve V<sub>1</sub>. The potentials across the right-hand half of L<sub>1</sub> are communicated to the grid G<sub>2</sub> of the second valve V<sub>2</sub> which acts as an aperiodic amplifier, the high-frequency potentials across R<sub>1</sub> being communicated to a third amplifying tube V<sub>3</sub>. The potentials across R<sub>2</sub> are brought back to the grid G<sub>1</sub> of the first valve V<sub>1</sub>, and are sufficiently strong to produce steady continuous oscillations in the circuit L<sub>1</sub> C<sub>1</sub>, even when the value of the capacity of the condenser C<sub>1</sub> is very high. This circuit is also very useful for producing alternations in circuits using iron-core inductances. In these circuits radio-frequency transformers might be used between valves, instead of ohmic resistances. (Abstracted from the "Electrical Review.")

### The Chicago Radio Convention

(Continued from page 282)

described a new concrete achievement of their own. Paul Godley, R. F. Gowen, K. B. Warner and E. F. W. Alexanderson were among the speakers.

### Short-Wave Regenerative Receiver Without the Use of Variometers

(Continued from page 292)

condensers, which was by no means an easy job, inasmuch as it meant the making of two new shafts and end bearings, also the capacity of each was reduced below the expected .0005, due to the fact that several rotary plates had to be sacrificed.

The primary consists of an inductance of 25 turns, double bank wound on 3½" diameter cardboard tubing, a variable condenser and a double-pole, double-throw key switch for changing the condenser from series to parallel connection.

The secondary consists of a secondary coupling, a secondary loading inductance, plate coupling coil, back coupling condensers, variable condenser, together with the tube accessories. The secondary coupling coil is 20 turns of litz on a 2¼" diameter hard rubber tube, mounted at 45 degrees to the shaft and inductive to the primary inductance coil, which is mounted 45 degrees to the panel. This scheme of mounting was employed for the reason that it required less space than other types. The secondary loading inductance consists of eight turns of litz in a figure eight type coil and is coupled to the magnetic plate coupling coil, which, also, is of the figure eight type; the diameter of the figure eight coils is four inches. This figure eight type coupling arrangement is very economical of space and is a very efficient type. The back-coupling condensers were built of copper foil and .002-inch mica, the plate side consisting of three plates each ½" x ¼"; the grid side has one plate of the same dimensions and the common side has four plates of the same dimensions.

The grid condenser must be quite small, about .00025 mfd. The grid leak can be a standard one or two meg. leak.

In operating the receiver, the antenna coupling and magnetic plate coupling as well as the secondary condenser are the critical adjustment factors—each adjustment of one of the above mentioned necessitates close adjustment of the others, and it will be found that very loose coupling is required to obtain the best results.

READ the CLASSIFIED ADVERTISEMENTS on PAGES 364-366. YOU'LL FIND MANY GOOD THINGS THERE





## The Recognized Symbol of Superior Performance

SO that all radiomen may know their nearest dependable source of supply we publish the names of leading dealers over the country who stock good Radio products INCLUDING AMRAD. Give your nearest dealer a chance to serve you.

### FIRST DISTRICT

C. B. Chase, 94 Railroad Street, St. Johnsbury, Vt.  
Francis L. Stanley Co., 302 Essex St., Salem, Mass.  
George A. Hill Co., 338 Middlesex Ave., Lowell, Mass.  
Wood Electrical Construction Co., 72 Exchange St., Lynn, Mass.  
F. D. Pitts Co., 12 Park Sq., Boston, Mass.  
DeLancey, Felch & Co., 12 Meeting St., Pawtucket, R. I.  
Whitall Electric Co., 336 Bridge St., Springfield, Mass.  
W. D. Kendall Co., 268 Main St., Worcester, Mass.  
Daniel C. Fox, 103 Washington St., Haverhill, Mass.  
Crown Light Supply Co., 110 Crown St., New Haven, Conn.  
"Ark" Radio Supply, Shelton, Conn.  
Spafford's 211 Trumbull St., Hartford, Conn.  
Berkshire Electric Co., 77 Eagle St., Pittsfield, Mass.  
Auburn Electric Co., 57 Court St., Auburn, Me.  
Auto Supply Store, 29 Center St., Bath, Me.  
A. T. Thurston, Rockland, Me.  
Farrell Bros., 99 Amherst St., Manchester, N. H.

### SECOND DISTRICT

Shotton Radio Manufacturing Co., 8 Market St., Albany, N. Y.  
American Electro Technical Appliance Co., 235 Fulton St., New York City.  
Continental Radio & Electric Corp., 6 Warren St., New York City.  
Westchester Electric Appliance Co., 253 South Broadway, Yonkers, N. Y.

### THIRD DISTRICT

Joseph M. Zamoiski Co., 19 North Liberty St., Baltimore, Md.  
Jere. Woodring & Co., Hazelton, Pa.  
Philadelphia School of Wireless Telegraphy, 1533 Pine St., Philadelphia, Pa.  
Shotton Radio Mfg. Co., Box No. 3, Scranton, Pa.  
White & Boyer Co., 812 13th St., N. W., Washington, D. C.  
Howell Bros., 602 East Broad St., Richmond, Va.  
Lancaster Elec. Supply & Construction Co., Lancaster, Pa.

### FOURTH DISTRICT

Carter Electric Co., 63 Peachtree St., Atlanta, Ga.

### FIFTH DISTRICT

Southwest Radio Supply Co., 217 North St. Paul St., Dallas, Tex.

Hurlburt-Still Elec. Co., Capitol Ave. and Fannin St., Houston, Texas.  
Union Elec. Co., 42 North Second St., Memphis, Tenn.  
Herbrick & Lawrence, 607 Church St., Nashville, Tenn.  
Nola Radio Company, 134 Chartres St., New Orleans, La.

### SIXTH DISTRICT

Western Radio Electric Co., 550 South Flower St., Los Angeles Cal.  
California Electric Supply Co., 643 Mission St., San Francisco, Cal.  
Southern Electrical Co., 3d and E Sts., San Diego, Cal.  
Noon's Electric Shop, 138 Grand Ave., Nogales, Arizona.

### SEVENTH DISTRICT

Glasgow Electric Shop, Orpheum Bldg., Glasgow, Montana.  
Northwest Radio Service Co., 609 Fourth Ave., Seattle, Wash.

### EIGHTH DISTRICT

Devon Electric Co., 613 Liberty Ave., Pittsburgh, Pa.  
Rudolph Schmidt & Co., 51 Main St., East, Rochester, N. Y.  
Bear-Cat Battery Service, Lemoyne, Pa.  
The Radioelectric Shop Co., 919 Huron Road, Cleveland, Ohio.  
Newman-Stern Co., East 12th St. and Walnut Ave., Cleveland, O.

Precision Equipment Co., 2437 Gilbert Ave., Cincinnati, O.  
Kramer Hardware Co., 138 East Third St., Dayton, O.  
Henry L. Walker Co., 27 Jefferson Ave., East, Detroit, Mich.  
Barker-Fowler Electric Co., 117 E. Michigan Ave., Lansing, Mich.

### NINTH DISTRICT

The Alamo Sales Corporation, 517 People's Bank Bldg., Indianapolis, Ind.  
Chicago Radio Apparatus Co., 508 So. Dearborn St., Chicago, Ill.  
U. of I. Supply Store, Champaign, Ill.  
Klaus Radio Co., Eureka, Ill.  
Pioneer Electric Co., 137 East 5th St., St. Paul, Minn.  
Sterling Electric Co., 29 Fifth St., South, Minneapolis, Minn.  
Karlawa Radio Corporation, 611 Best Bldg. Rock Island, Ill.  
Linze Electrical Supply Co., 1129 Olive St., St. Louis, Mo.  
Central Radio Co., Inc., 316 East 19th St., Kansas City, Mo.  
Wolfe Electric Co., 313 South 17th St., Omaha, Neb.  
Bullock's Sporting Goods, York, Neb.

### CANADA

Scientific Experimenter, Ltd., 11 St. Sacramento St., 33 McGill College Ave., Montreal (and all branches.)

### DEALERS:

Over 60 reputable dealers now stock the Amrad line which is rapidly gaining favor everywhere. There are several good territories still open. Reliable dealers should get our new Trade Policy.

### AMATEURS:

Have you seen our *new* quality receiving apparatus? Send for new Bulletins L, N, O, and T just off the press. Complete catalog 10c in stamps.

# AMERICAN RADIO AND RESEARCH CORPORATION

New York District Office  
15 Park Row

General Office, Factory and Laboratory  
203 College Avenue, Medford Hillside, Mass.  
(SUBURB OF BOSTON)

Chicago District Office  
600 So. Dearborn St.





Shramco  
Switch  
No. 750  
Price 75c

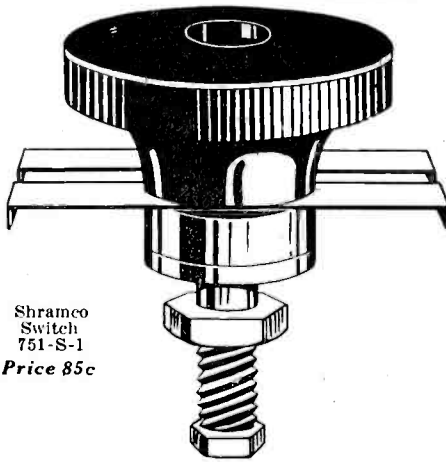

Shramco  
Switch  
751-S-1  
Price 85c

## Two Shramco Switches

**Y**OU CAN hardly afford to take chances of losing efficiency by getting along with poor switches. Either of these two styles will distinguish itself by smooth operation and sure contacts, in addition to the handsome appearance. Both have polished nickel finish and are furnished with large Marconi type knob. Bearing block and panel bushing  $\frac{3}{4}$ " in diameter. For use on all panels up to  $\frac{1}{2}$ " thick. Blades, spring phosphor bronze. No. 750 type has spring tension adjustment; switch radius,  $1\frac{1}{2}$ ".

No. 751-S-1 type is provided with split lock nut; blades have 1" radius,  $\frac{1}{2}$ " from center to center, and are securely held in place. If your dealer cannot supply you, send your order direct, postage extra. Dealers who have not a supply of Shramco switches should write for proposition at once.

*For your VT detector, amplifier, and power tubes—*

use the famous Shramco Reos, with "Nichrome" resistances. Type 90, 6 ohm resistance, for detectors and amplifiers, \$2.00, plus postage for two pounds. Type 90P, the new Reo specially

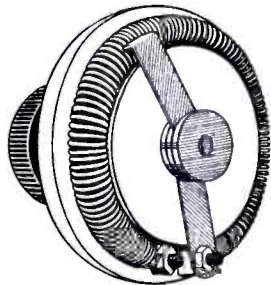

designed for Radiotron U.V. 202, with 1.5 ohm resistance, \$2.00, plus postage for one pound. Ask your radio dealer or send your order direct.

**SHOTTON RADIO MFG. CO., INC.**  
P. O. Box 3, Scranton, Pennsylvania

*Catalogue "K", listing a complete line of high grade parts at reasonable prices, sent to any reader of Radio News for five cents in stamps.*

## The New KLAUS ROTARY SWITCH

ANOTHER ORIGINAL AND UNIQUE PRODUCT

There is NOT a MOVING PART on the entire assembly except the knob and blade. The shaft and collar remain stationary, thus insuring a positive and permanent contact. No loosened connections with a Klaus Switch.

Order one today for that new set and send for list of new instruments.

R  
KLAUS  
D  
I  
O

**KLAUS RADIO CO.**  
EUREKA, ILLINOIS

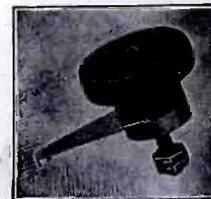

Price 60¢

READ the CLASSIFIED ADVERTISEMENTS on PAGES 364-366 YOU'LL FIND MANY GOOD THINGS THERE.

## Long Wave Reception

(Continued from page 292)

stations. Whenever a station of a known wave-length is heard, get the condenser reading by making the primary coupling very loose and then tuning the secondary condenser to the zero beat. Locate the point with the wave-length and condenser reading on a piece of graf paper and make a dot there. After several such points are located the curve can be drawn. After the curves are drawn, to identify an unknown station, get the condenser reading, and then by reference to the chart find the wave-length. Then find what stations are on that wave-length. If the list of stations shows whether they have an "a," "b," or "c" wave, it is much easier to be sure which one is heard.

The longer wave stations on the list I believe to be accurately listed, but there are doubtless many errors among the shorter waves, as I have not paid much attention to those below NDD. I would be glad to see corrections and additions to this list.

## Short Wave Regenerative Receiver

(Continued from page 314)

ways be sufficiently near the 180-degree point of the scale to have oscillations generating all the time tuning is being done. That is, if your incoming oscillation is 1,500,000 cycles, you tune your set to generate oscillation having a period of 1,499,000 cycles, a difference of 1,000 cycles, and get a corresponding note in the telephones. This oscillation set up in the receiver can be varied by varying the tertiary control and any note desired produced in the telephones from inaudibility to a few cycles a second.

Inability to oscillate may be due to low filament temperature, low high potential battery, low grid leak, the tertiary circuit being improperly connected. To remove the trouble of the telephone cords acting as coupling from the tertiary circuit back through the body to the secondary circuit, the receiver case may be lined with sheet copper, connected to the negative side of the filament battery and grounded. The telephone cord should also be covered with copper braid and grounded as well. With this receiver connected in conjunction with a two-step radio frequency amplifier and a two-stage audio frequency amplifier, all the best western stations are heard in Boston every night and even in the daytime. On 600 meters we hear ships up and down the coast from Cape Race to the Panama Canal loud enough to read and copy on a typewriter without any difficulty from interfer-

## Determining Condenser Capacity

(Continued from page 297)

reservoir, into which is forced a compressible fluid; the quantity of fluid stored in the reservoir will be governed by two factors: first, the capacity of the reservoir; and second, the pressure at which the fluid is supplied. Similarly the quantity of current in coulombs (Q) stored in a condenser is equal to the product of the capacity in farads (C) multiplied by the pressure in volts (E). Therefore  $Q = EC$ . And since the charging process is uniform, the average or effective voltage of the condenser will be equal to one-half of the maximum

voltage, or  $E = \frac{E}{2}$ . Therefore, the work



# AIDS TO BETTER RADIO WORK

## PACENT RADIO JACKS

The New Pacent Radio Jacks are fit companions for the Pacent Universal Plug. Like the Plug they are not improvised telephone equipment, but have been designed especially for Radio. They are small, neat, and rugged. The most convincing proof that they are the best jacks for radio is the fact that Commercial Radio Companies are standardizing on them.

### Standard Types

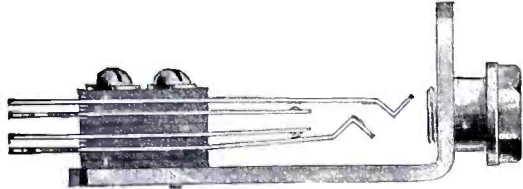

Cat. No. 61 Open Circuit, Price.....\$ .70  
 Cat. No. 62 Closed Circuit, Price..... .85  
 Cat. No. 63 Two Circuit, Price..... 1.00

### Automatic Types

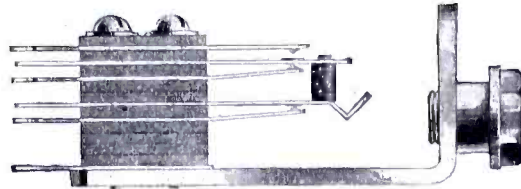

Cuts off filament current when plug is removed.  
 Cat. No. 65 Three Spring Type, Price.....\$1.20  
 Cat. No. 66 Five Spring Type, Price..... 1.50

### The Pacent Universal Plug

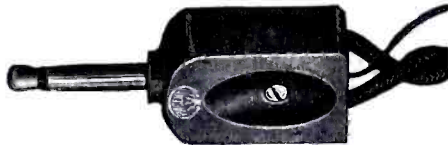

**Price \$2.00**

No connections to solder. Essential for modern radio, for transmission and reception. Approved by the Navy Department. Endorsed by foremost radio amateurs. We lead, others follow.

### DUBILIER CW CONDENSER

For Antenna Series Use Type 580 For General C. W. Duty

#### MADE IN

Single Capacities  
 0.001 mfd.  
 0.002  
 0.005  
 0.01  
 0.02

**Price \$4.00**

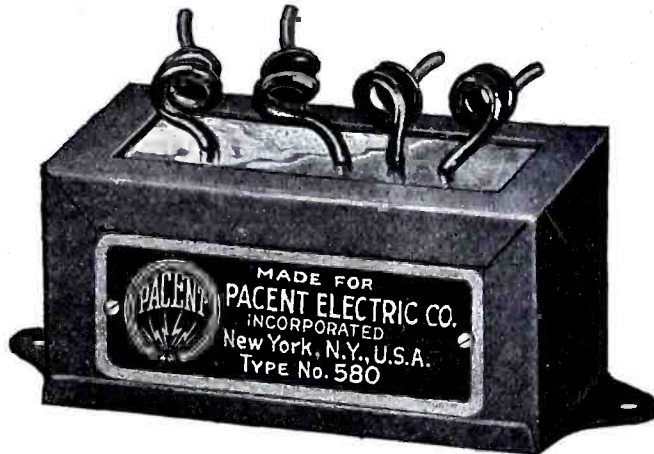

#### CAT. No. 310

Triple Capacity  
 0.0003 mfd.  
 0.0004  
 0.0005  
 5,000 volts  
 4 amperes

**Price \$4.50**

### Pacent Standard VT Batteries



Supreme in the radio field. Guaranteed to give satisfaction. Silent in operation. The Standard "VT" Batteries are now supplied in the black and white boxes with diamond-shaped labels.

Prices range from \$1.50 to \$3.50 each

### The Dubilier Universal Condenser

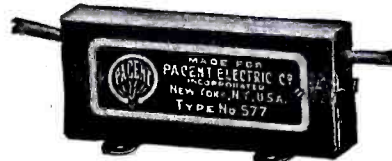

**Type 577  
 Price \$2.00**

For transmission and reception. Supplied in most used capacities from 0.01 to 0.00025 mfd. Especially designed for C.W. Will carry 1 ampere at 1000 volts. Standard by many radio companies.

# PACENT ELECTRIC COMPANY, Inc.

LOUIS GERARD PACENT, President

Sole Distributors for Wicoony's Complete Line of "Eventual" Apparatus.

Duo-Lateral Coils  
 Standard VT Batteries  
 Pacent Plugs

Special Distributors for Brandes Phones

**150 NASSAU STREET**



Dubilier Condensers  
 Rawson Instruments  
 Selbt Instruments

Special Distributors of Westinghouse Equipment.

**NEW YORK CITY**



**Station Type**

In handsome mahogany cabinet, as shown.

**\$30.00**

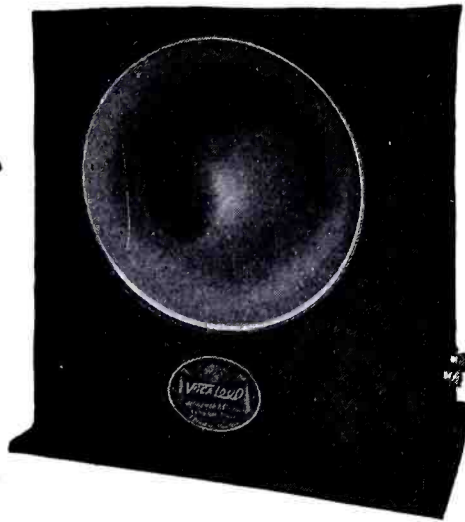

**Laboratory Type**

Mounted on metal base, adjustable height

**\$25.00**

The

# VOCALLOUD

**T**HE IDEAL loud-speaker. Requires no batteries, no adjustments, no extra equipment whatever. Just hook VOCALLOUD right on to your receiving apparatus

and listen to your signals, —QSA all over your house! Uses genuine Baldwin reproducer,—equally good for telephone and telegraph. Your order shipped at once!

## CORWIN'S improved SWITCH LEVER

Sure contacts, smooth operation, handsome appearance—all are characteristics of this improved switch. Many switches give their manufacturers more profit—none give their users more satisfaction. Try a Corwin Switch. As good as it looks!

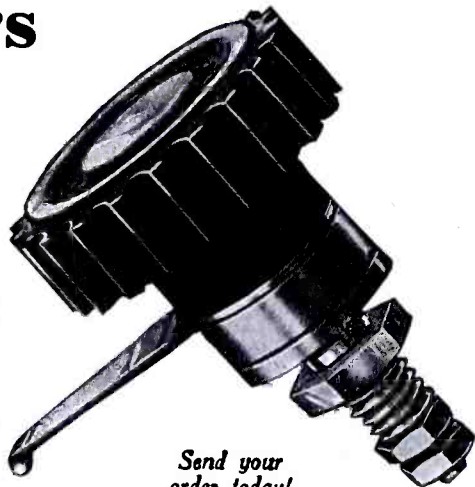

Send your order today!

**PRICE: 90 cents, Postage, 5 cents.**

Composition knob, identical with knobs used on standard No. 67 Corwin Dial. Brass shaft is moulded right into knob — it can never come loose. Blade, bushings, etc., nickel-plated brass. Contact radius, 1/4 inch.

## Universal-Coil Mounting Plugs

For Radisco and all hand wound coils. No bending, no filing, they fit exactly in the first place.

80 cents postpaid

All orders for apparatus not listed as postpaid must be accompanied by postage charges.

**CORWIN'S 1921 CATALOG 10c**  
Send for your copy today!

## New Radisco Vario-Coupler

Accurate to the .002 part of an inch. Moulded base, Formica tube, all metal parts brass.

\$7.50 postpaid

**A. H. CORWIN & CO.**  
Dept. B2, 4 W. Park St., Newark, N. J.

Remember Corwin's reputation for shipping mail orders promptly and in perfect condition.



## "PROFCO" The Compact Set

After careful study and experiments we have brought out the Smallest compact, durable, efficient and attractive detector and amplifying sets on the market to-day.

It is a set that you will be proud to have in your station, taking up less room than an ordinary box camera.

The main feature of these sets is that the tubes are inserted upright which saves the Filament from sagging and therefore prolonging life of same.

**DETECTOR AND TWO STEP (TYPE A) \$55** (Size 9 in. Long, 5 1/2 in. wide and 3 in. high)  
**DETECTOR AND ONE STEP (Type A) \$40** (Size 6 in. long, 5 1/2 in. wide and 3 in. high)  
Prompt Shipments Express Prepaid in U. S.

Write for descriptive bulletin.

"ALL STANDARD PARTS CARRIED IN STOCK"

**PROFESSIONAL RADIO ASSEMBLING CO.**

SAMUEL SCHNEIDER, Manager.  
133 CROSBY STREET Dept. N NEW YORK

## MONEY for You

Add to your Salary—Make extra Pin Money. Start a lucrative business of your own. Spend an hour each day taking subscriptions for the "Radio News." We'll pay you well and you'll enjoy the work. Write for full particulars. Circulation Dept., RADIO NEWS, 236A Fulton St., New York City.

in Joules (J) equals the product of the quantity (Q) multiplied by the voltage (E),

$$J = Q \times E = E \times C \times \frac{E}{C} = \frac{E^2 C}{2}$$

Now as the Joule is equal to the product of the volts, amperes, and time in seconds (one watt-second)  $J = EIt$ , the power in watts (P) may be expressed by multiplying by the number of charges or discharges per second; and further, the capacity in farads may be reduced to the more convenient term, microfarads by dividing by one million, or  $10^6$ , hence the power in the con-

denser in watts becomes  $P = \frac{NCE^2}{2 \cdot 10^6}$  and,

in the case of the spark transmitter, in order to obtain the maximum efficiency with a given power, condenser capacity, and voltage, the number of sparks that should pass at the discharge wheel, by inversion of

the equation, is equal to  $N = \frac{2 \cdot 10^6 P}{CE^2}$

where N equals the number of sparks per second at the gap.

## Junior Constructor

(Continued from page 307.)

was good, more would be better, and it was. I left the cells on the stove until steam formed in them. When the wax on top began to melt, and the steam popped the contents half out of the cells, I quickly removed them and pressed the wax and the contents back into the zinc retainers.

The cells were apparently restored to their full power, and did not lose it when cold. I am still using the heat rejuvenated cells in my radio set, and they work as well as when new.

The heat, of course, must have acted as a depolarizing means and set the battery back in condition.

Contributed by

THEODORE A. CUTTING.

## In a Radio Store

(Continued from page 302)

dragging LITTLE LEON by the hand. MAMMA weighs a good 200 pounds and LITTLE LEON would have to have a storage battery in his pocket before he could make the scales work.)

FOND MAMMA (to CLERK): Young man, my little son here (pats LITTLE LEON lovingly) has long wished to become a wireless operator. (To LITTLE LEON) Haven't you, darling?

TIRED CLERK (aside): Oh, Lord!

FOND MAMMA: And so I have decided that he is now old enough. (TIRED CLERK pulls feverishly at his collar.) How much do the outfits cost?

TIRED CLERK (nervously): Well, you see, ma'am, there are a number of different . . .

FOND MAMMA: Leon, what kind was it you wanted?

LITTLE LEON (in a high soprano): I want a nith thiney one.

TIRED CLERK (frowns down at LITTLE LEON with a worried expression): Did you speak?

FOND MAMMA: He means "a nice shiny one," don't you, darling?

LITTLE LEON (with energy): Yeth, with lots of brath and thilver.

TIRED CLERK (with an "all is lost" expression): Yes, yes, I see. Well, the shiny ones are in demand now. Did you wish to send or receive?

FOND MAMMA (haughtily): I'll pay cash and take it with me.

TIRED CLERK (in desperation): Well, you see there are two ways . . . er, ah, one can send or one can receive and (glancing



# For Receiving Circuits



**Amplifying Transformer**  
 Model UV-712  
 Price, \$7.00

A new inter-tube tone-frequency amplifying transformer designed to make Radiotron Detector, UV-200 and Radiotron Amplifier Tube, UV-201, the most effective vacuum tubes on the market today. Tests have proved this conclusively.

Special bulletin containing detailed data and circuit diagrams for the use of UV-712 will be sent upon request.

These Standard Grid Leaks are in use everywhere in radio circles, from the largest laboratory to the most humble amateur station. They are of rugged construction, and of uniform and constant resistance. These Standard Grid Leaks are an absolute necessity for stabilizing the operation of vacuum tube detectors and amplifiers.

Write for our Grid Leak Bulletin. It explains the use of Grid Leaks in radio-receiving circuits.

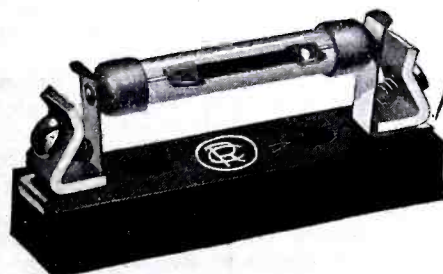

**Standard Grid Leak**  
 Complete, \$1.25  
 Mounting only, \$.50. Units any value from .15 to 6. megohms, \$.75

## AMATEURS

The four accessories here illustrated are made according to the same high standards set for Radiotron Vacuum Tubes—famous throughout the amateur field.



**"A"**  
**Battery Potentiometer**  
 Model PR-536  
 Price, \$2.00

Close variation of the plate voltage of detector tube, Radiotron UV-200 often means the reception of otherwise unreadable signals from great distances. Using our Potentiometer, Model PR-536, you can really locate the most sensitive point on the characteristic curve. This potentiometer is unusually well built and superior to those heretofore supplied to the trade.

Thousands of these sockets are now in use throughout the amateur field. They will fit the Radiotrons UV-200, 201, and 202, insuring reliable contact under all operating conditions. Moulded unit made to fit and last, and backed by the RC stamp of quality.

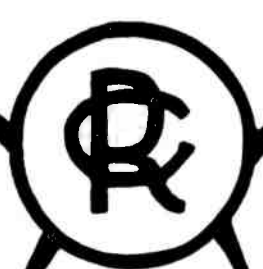

## IMPORTANT

Send 25 cents for the new C. W. Transmission Book and Catalogue of Radio Apparatus.

## DEALERS

Here is an unusual opportunity to handle the products of the greatest organization of its kind. Be one of the first to profit by this line.

Write Today

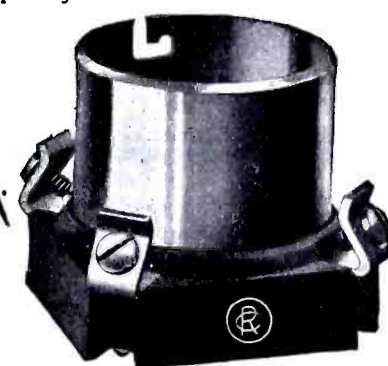

**Standard Bakelite Socket**  
 for Radiotrons UV-200,  
 UV-201, UV-202  
 Price, \$1.50

**Radio**  **Corporation**  
 of America

Sales Division, Commercial Department, Suite 1802  
 233 Broadway, New York City



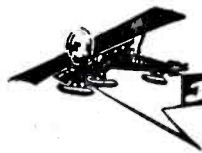

**EASTERN  
RADIO**

**INSTITUTE**

TEL.  
BACK BAY  
5 9 6 4

899 BOYLSTON ST.  
BOSTON, MASS.

## SPARK--ARC--VACUUM TUBE

The Revised Examinations for Commercial Operators including ARC and VACUUM TUBE is carefully and fully covered by the Course of Instruction offered by the EASTERN RADIO INSTITUTE. Intelligent students INSIST on being taught upon ACTUAL apparatus!

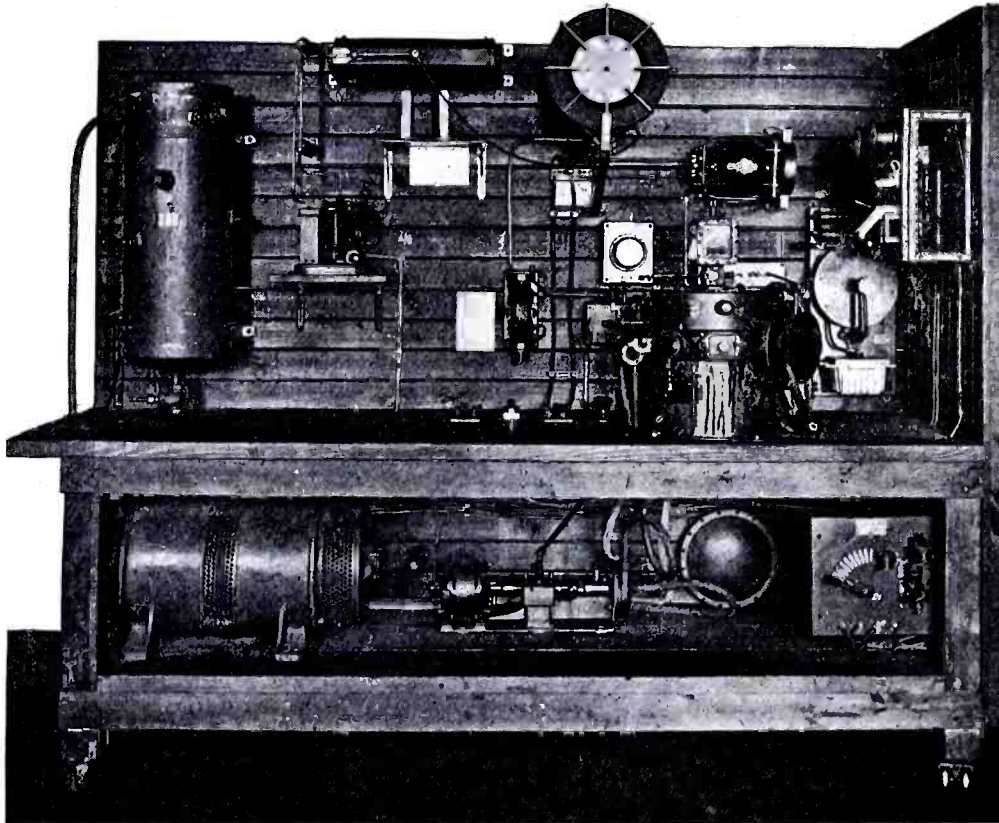

"The EASTERN RADIO INSTITUTE'S 2 K.W. 'ARC'"

The EASTERN RADIO INSTITUTE is the OLDEST, LARGEST and BEST EQUIPPED Radio School in New England. The Pioneer school that has always led the way! Ask any man in Radio—he will tell you!

New Students can begin to advantage in the Day or evening school on any Monday.

REMEMBER:—Our ORGANIZATION with YEARS of PHENOMENAL EXPERIENCE and SUCCESS is behind every man who enrolls. Ask a man in Radio he will tell you! OVER 4000 satisfied graduates TELL OUR STORY BEST! Why not be one?

Our illustrated prospectus is free. If you cannot visit the Institute send for one.

**F. D. PITTS, Director**

## Quality Radio Equipment

### GREBE CR-5 REGENERATIVE RECEIVER

150 - 300 Meters

GIVES REAL RESULTS



A complete Receiver—only additional equipment needed are phones, batteries and detector tube. Includes in its range amateur, commercial and Navy wave lengths, special land stations, ship CW stations, Navy low wave arcs and "Time". Especially efficient for Radio phone and CW reception. Ease of operation unparalleled.....

**\$80.00**

**SPECIAL** Thordarson 1-KW Type R Transformers reduced because of overstock—Formerly \$40.—While they last **\$25.00**

Full line of Radiotron Vacuum Tubes and Accessories and other Highest Grade Radio Supplies.

Mail orders promptly filled — Dealers—Write for Discount

## DOUBLEDAY-HILL ELECTRIC CO.

715 Twelfth St., N. W., Washington, D. C.

Radio Dept.—Desk B

719-21 Liberty Ave., Pittsburgh, Pa.

anxiously around him) one can do both.

FOND MAMMA: Oh, I see. I think we'd better just . . . Leon, what do you want to do, send or receive?

LITTLE LEON: I gueth I'd rather thend.

TIRED CLERK (*somewhat relieved*): What kind of current have you in your home, ma'am?

FOND MAMMA: Why, the very best, of course.

TIRED CLERK (*staggered and nearly collapses on the counter, but saves himself and continues*): I mean have you A.C. or D.C.?

FOND MAMMA: A.C.? D.C.?

TIRED CLERK: Well, never mind, I guess we can fix you up with batteries. (*Brings out a small spark-coil from the show case.*) This is a very fine instrument, ma'am; six dry cells will run it nicely.

FOND MAMMA (*examining it critically*): It has a very high polish. Is this shiny enough, Leon, dear?

LITTLE LEON (*with glee*): I'll bet it'll thend great.

TIRED CLERK (*trots out more apparatus until the counter is pretty well littered up. Then he gets a pencil and paper, smiling wanly*): Now I'll give you a good hook-up.

FOND MAMMA (*angrily*): Sir!!! (*Whispers something hastily to LITTLE LEON, who runs behind her and examines the back of her gown.*)

LITTLE LEON: No, mamma, everything ith hooked up.

FOND MAMMA (*to TIRED CLERK*): So! I thought as much! Young man, I shall make purchases in this shop only when the proprietor has engaged civil employees. Good day! Come, Leon! (*She sweeps majestically out followed by LITTLE LEON, leaving the TIRED CLERK standing dumb-founded beside the huge bundle.*)

TIRED CLERK: Well, I'll be . . . (*Steps over to a looking-glass to adjust his rumpled collar and tie. Enter the HARD BOILED HAM.*)

HARD BOILED HAM: I wanna good short-wave tuner. Watcher got?

TIRED CLERK (*aside*): Ha, a live one. (*To the HARD BOILED HAM*) How about the "Whiffle"; up to 600 meters?

HARD BOILED HAM (*leaning on the counter and blowing cigar smoke at the TIRED CLERK*): Trot 'er out!

TIRED CLERK (*gets tuner down from shelf and puts it on counter*): This is really a very fine instrument. Here's your plate variometer, your grid variometer and this is your coupling. Ever see anything neater? And believe me, this baby delivers the goods.

HARD BOILED HAM (*studies the instrument for a moment*): Hmm, uh, uh, let's see the works.

TIRED CLERK: Certainly. (*Gets a screw-driver and removes panel.*) There you are! Just as pretty inside.

HARD BOILED HAM (*fingering the coils*): Cheap stuff, cheap stuff. What's the tax?

TIRED CLERK: Sixty-seven fifty list.

HARD BOILED HAM (*never batting an eye*): Not as bad as it might be. What else yer got?

TIRED CLERK (*reflecting a moment*): Well, we've got the "Zowie XY 12" put out by the Goofus people. That has the added feature of verniers on the variometers.

HARD BOILED HAM (*flecking his cigar ash over the showcase*): Let's see it. (*The TIRED CLERK gets the instrument and the HARD BOILED HAM examines it carefully. This goes on for some time until the counter is piled high with expensive tuners, all of which sell for around fifty dollars. Then*): Say, by the by, you ain't got one of them little single slide tuning coils what used to sell for 65 cents, have you?

TIRED CLERK (*now completely exhausted*): I think so. (*Looks under the counter.*) Here you are.



# RADIO APPARATUS

*Distributors of Reliable Radio Apparatus to  
Schools, Colleges, Radio Clubs and Experi-  
menters All Over the World!*

"PITTSO"

SERVICE FILLS ORDERS FOR  
"GREBE RADIO" ANYWHERE!  
THAT APPARATUS of PROVEN MERIT



"PITTSO"

SERVICE DISTRIBUTES "RADIO  
CORPORATION'S" PRODUCTS ALL  
OVER THE WORLD!  
TRY US AND SEE!

**AMPLIFYING TRANSFORMERS**

No. UV-712 Radio Corporation.....	\$7.00
No. P-1 Amrad, mounted.....	4.50
No. P-2 Amrad, unmounted.....	3.75
No. QO Clapp-Eastham, semi-mounted.....	4.00

**AMPLIFIERS**

No. DA Westinghouse, Detector and two stage, in beautiful cabinet.....	65.00
No. RORK Grebe two step with automatic filament control, a beauty.....	55.00
No. RORD Grebe Det. and two stage with automatic filament control.....	75.00
No. P-1 Amrad two stage in 10x5, cabinet, splendid value.....	\$2.50

**AUDION CONTROL PANELS**

No. RORH Grebe in cabinet, with tickler connections, hinged cover.....	17.00
No. RORA Grebe in cabinet with hinged cover, special value at.....	9.75
No. 330 Remler, with "A" Bat. potentiometer, just out.....	8.00
No. P-1 Paragon, moulded type.....	6.00

**ANTENNA WIRE**

"Pittsco" No. 14 hard drawn copper, 80 ft. per lb. Per lb.....	0.40
500 ft. special value at.....	2.25
"Pittsco" 7 strand No. 22 tinned copper, 65 ft. per lb., per ft.....	0.01
500 ft. special value at.....	4.50
"Pittsco" 7 strand No. 20 Phos. Bronze, per ft. 500 ft. special value at.....	0.02 8.50

**GROUND EQUIPMENT**

No. P-1 100 Amp. 600 Volt ground switch, special value at.....	3.95
No. P-2 ground wire No. 4 weatherproof, per ft. special value at.....	0.06
No. P-3 Porcelain cleats with screws for No. 4 wire, per pair.....	0.10
No. P-4 "Pittsco" ground clamp.....	0.20

**"B" BATTERIES**

No. 7623 Standard, 22.5 V. Small.....	1.50
No. 7625 Standard, 22.5 V. large.....	2.65
No. 7650 Standard, 22.5 V. variable.....	3.50
No. 763 Everready, 22.5 V. small.....	2.25
No. 766 Everready, 22.5 V. variable, 16 1/2 to 22 1/2 Volts, large.....	3.00
No. 766 Everready, 22.5 V. large.....	3.50
No. P-1 Sorsinc, 22.5 V. large, and extra long life.....	4.00

**CONDENSERS—(Fixed mica type)**

No. 577 Dubilier, Universal type, for transmission and reception, suitable capacities. .0025, .005, .01, .025, .05 or .01 MF each.....	2.00
No. ROCC Grebe .0002 MF.....	1.00
No. ROCD Grebe .0005 MF.....	1.20

**GRID LEAKS**

No. MW-1 Radio Corporation, 1/2, 1, 1.5, 2, 3 or 5 megohms, each complete.....	1.25
Grid leaks only.....	0.75
Bases only.....	0.50

**HOT WIRE METERS**

No. P-1 Reller Smith, 0-2.5 flush mounting. A real value for.....	4.75
No. 127 General Radio, .5, 1, 2.5, 5 or 10 amps. flush or front mtg., each.....	7.75

**LOUD SPEAKERS**

No. R-3 Radio maxnavox, latest model.....	45.00
No. P-1 Phonetron, just out.....	45.00
No. P-2 Vocaloud, station type.....	30.00
No. P-3 Vocaloud, Laboratory type.....	25.00

**PLUGS**

No. 50 Pacent Universal type.....	2.00
No. 1428-W Federal, Brass.....	2.00
No. 1428-W Federal silver-plated.....	2.50

**REGENERATIVE RECEIVERS**

No. CR-2 Grebe, 175-680 meters, a special value at.....	39.95
No. CR-3 Grebe "Relay Special," 175-680 meters.....	65.00
No. CR-3A Grebe 175-375 meters, with tube control, complete set, a special value at.....	35.95
No. CR-5 Grebe 175-3000 meters, "Super-special," complete set, ideal for phone, spark and time signals.....	80.00
No. RA Westinghouse, 180-700 meters, very selective, beautiful cabinet.....	65.00
No. RC Westinghouse, RA Receiver and DA Det.-Amplifier combined in one cabinet, splendid unit, compact.....	125.00

**SOCKETS**

No. MW-1 Radio Corporation, bakelite.....	1.50
No. UT-541 Radio Corporation for UV-203 tube.....	2.50
No. 156 General Radio, new price.....	1.50
No. 550 Murdock, moulded.....	1.00
No. P-1 Amrad, new price.....	0.75

**RECTIFYING DEVICES**

No. UV-216 Radio Corporation, 20 Watt "Kenotron" rectifier, for UV-202 tubes.....	7.50
No. UV-217 Radio Corporation, 150 Watt "Kenotron" rectifier, for UV-203 tubes.....	26.50
No. P-1 De Forest, 20 watt rectifying tube, for use with 5 watt tubes.....	7.00

**TELEPHONES**

No. 56 Murdock, double, 2000 ohms.....	5.00
No. 58 Murdock, double, 3000 ohms.....	6.00
Brandes, Superiors, double.....	8.00
Brandes, Transatlantic, double.....	12.00
Brandes, Navy Type, double.....	14.00

**POTENTIOMETERS**

No. PR-536 Radio Corp. "A" Bat. type.....	2.00
No. 93 Remler "A" Battery type.....	0.75

**VACUUM TUBES**

No. UV-200 Radiotron detector.....	5.00
No. UV-201 Radiotron Amplifier.....	6.50
No. UV-202 Radiotron 5 watt transmitter.....	8.00
No. UV-203 Radiotron 50 watt transmitter.....	30.00
No. UV-204 Radiotron 250 watt transmitter.....	110.00

*Note:—All Radiotrons sent postage and insurance prepaid anywhere in U. S. A. Send us your orders for Radiotrons!*

**RADIOPHONE AND CW APPARATUS. CW POWER TRANSFORMERS**

Acme 50 watt 350 volts, mounted.....	15.00
Acme 50 watt 350 volts, unmounted.....	12.00
Acme 200 watt 350-550 volts, mounted.....	20.00
Acme 200 watt 350-550 volts, unmounted.....	15.00
Acme 500 watt 1000-1500 volts, mounted.....	25.00
Acme 500 watt 1000-1500 volts, unmounted.....	20.00

**CHOKO COILS**

Acme single coil, 1.5 Hen., 150 MA.....	4.00
Acme double coil, 1.5 Hen., 150 MA.....	6.00
Acme single coil, 1.5 Hen., 500 MA.....	6.00
Acme double coil, 1.5 Hen., 500 MA.....	8.00

**CONDENSERS (Variable)**

No. 182-G General Radio .001 Mf., unmounted with dial.....	8.70
No. 3 Chelsea, .0011 Mf., unmounted.....	4.75
No. 366-Int Murdock .001 Mf., unmounted.....	4.25

**FILAMENT HEATING TRANSFORMERS**

Acme 75 Watt, mounted.....	12.00
Acme 75 Watt, unmounted.....	9.00
Acme 150 Watt, mounted.....	18.00
Acme 150 Watt, unmounted.....	13.00

**FILTERS**

No. 170 Tuska, in cabinet.....	16.00
No. 21-AA Western Elec. 1000 Volt AC. condenser.....	2.50

**INDUCTANCES, CW.**

No. 181 Tuska Cap. Feed-back circuit.....	7.50
No. 182 Tuska split filament.....	10.00
No. 183 Tuska grid tickler.....	12.50

**METERS**

Model 301 Weston, D.C. flush, 0-100, 0-150, 0-200, 0-300, 0-500 or 0-800 milli-amperes, each.....	8.50
Model 301 Weston D.C. flush, 0-1, 0-2, 0-3, 0-5 or 0-10 Amperes.....	8.50
Model 425 Weston, flush, Thermo-Ammeter, 0-1, 0-2.5 or 0-5 each.....	18.75
No. P-1 Jewel, A.C. flush 0-15 voltmeter, ideal for power tubes.....	8.00

**MICROPHONE TRANSMITTERS**

No. 5176-A Connecticut with adj. arm.....	4.00
No. HM-100 De Forest, hand type.....	6.00
No. 260-W Federal, hand type.....	7.00

**MODULATION TRANSFORMERS**

No. A-3 Acme Semi-mtd.....	5.00
No. A-3 Acme fully mounted.....	7.00
No. 231 General Radio, new type.....	5.00

**RHEOSTATS**

No. 560 Murdock, moulded, new type for back mounting.....	1.00
No. 214 General Radio, 2.5 Amp. type, just right for 1 UV-202 tube.....	2.50
No. 132 National Controller, 6.5 Amp. type, just right for 1 UV-203 tube.....	4.50

**RESISTANCES**

Type HS Ward Leonard 5000 ohms.....	2.75
Type HS Ward Leonard 10,000 ohms.....	3.50

**"Let 'PITTSO' products, super-service and delivery solve your Radio problems"  
SEND US YOUR ORDERS TODAY!**

Send ten cents in stamps for Catalog No. 22. Over 100 pages, over 150 illustrations, over 600 items

**F. D. PITTS CO., Inc.**

12 Park Square

Dept. C

Boston, Mass., U. S. A.



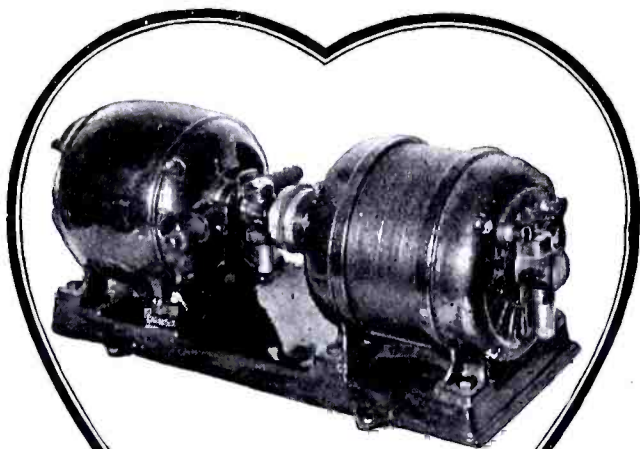

**THE HEART OF A RADIO TELEPHONE**  
**A RAY-DI-CO**  
 (REG. U. S. PAT. OFFICE)  
**MOTOR GENERATOR UNIT**

Has YOUR radiophone HEART FAILURE?  
 A sturdy radiophone like a sturdy man must have a strong HEART  
 A Ray-Di-Co motor generator is a sure cure.

**"MIDGET" "HYLO" "STANDARD"**  
**6 volt "DYNAMOTOR" 32 volt "DYNAMOTOR"**

At our new salesroom we carry a complete line of  
 REMLER MURDOCK FEDERAL GREBE  
 CLAPP-EASTHAM CONNECTICUT CONTINENTAL  
 ACME CHELSEA BALDWIN

and other STANDARD makes of apparatus, also parts and materials.  
 MAIL ORDERS GIVEN PROMPT ATTENTION

**THE RAY-DI-CO ORGANIZATION**  
 1547A N. WELLS ST. Radio 9AG CHICAGO, ILL.

**Announcing the New CINO ARISTOCRAT!**

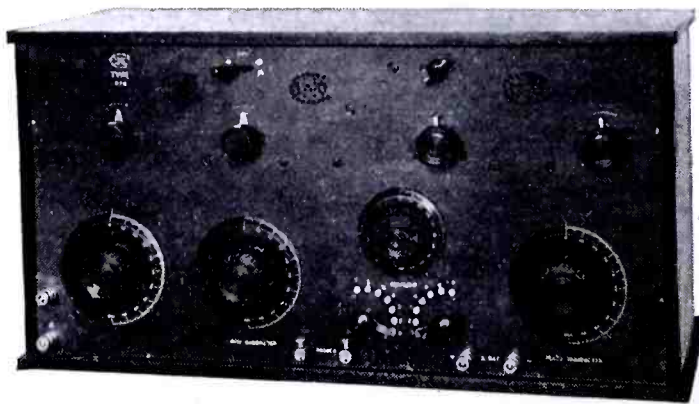

To meet the demand for our combined Tuner, Detector and Two-Step Amplifier in one cabinet!  
 This remarkable combination simply cannot be beaten. All capacity effects eliminated. Incorporates in the detector hook-up, a 400 ohm grid bias potentiometer, giving the most critical tube adjustment possible. Requires no grid condenser! Wave length 180 to 650 meters.

PRICE, fob Cincinnati, O., \$125.00

Do you build your own apparatus? We furnish complete parts for all of our units.

CROSLY PORCELAIN SOCKETS, 60c

**CINO RADIO MFG. CO.**

218 West 12th Street

Cincinnati, Ohio



"Radio 8-XY"



READ the CLASSIFIED ADVERTISEMENTS on PAGES 364-366 YOU'LL FIND MANY GOOD THINGS THERE

HARD BOILED HAM (putting the 65 cents on the showcase): Fine. That's what I wanted. Thanks. (Exit the HARD BOILED HAM while the TIRED CLERK falls in a faint across the counter.)  
 (CURTAIN.)

**High Voltage**  
 (Continued from page 302)

der against a trolley pole and after making sure the way was clear and free from all blue-coated upholders of the law who might not take any too kindly to my plans, I started to ascend. Right here, fellow amateurs, I weakened; 500 volts with plenty of amperage to back it up is not to be fooled with without due care. Since I had no desire to be found dead, arrested for wire tapping or being sent to the "nut house," I hesitated. But I was not lost, for thoughts of relay work and the sensation I would produce, made me bold. Slowly I scraped away the insulation from the heavy feed cable expecting to be killed at every stroke. At last I saw the glint of copper and with a slight motion of my arm I threw the wire over and that part of the deed was done. I rushed down and ran at top speed, for time was valuable, the coming of daylight would mean the removal of the wire. Reaching the house, I hurried to the Radio room where, on a table, lay a strange combination of condensers, inductances and a tangle of wire in the midst of which stood a lone and solitary tube. The high voltage wire was led gently to its proper place. Gently in order to avoid contact with numerous other wires and thus causing an uncalled for display of fireworks. Having made the connection, together with a few other minor  
 (Continued on page 362)

**A Study of the Antenna System**

(Continued from page 290)

obtained from a study of the reactance curves of the circuit. This is particularly true about the antenna system. As stated in a previous paragraph, the behavior of an antenna is similar to a reactance whose curve is a standard co-tangent curve. This reactance curve of an antenna is shown in Fig. 5, where the reactance of the antenna is plotted against different frequencies. The following will be observed from consideration of this curve. At certain definite frequencies as  $f_1, f_2, f_3$ , the reactance of the antenna is zero. These frequencies are the same as the natural period of the antenna and its harmonics, and it will be seen that for this simple case of an unloaded antenna the harmonic frequencies are odd multiples of the fundamental, that is, 3, 5, 7, etc., times the fundamental frequency of the antenna. Since the reactance of the antenna at these frequencies is zero, the antenna will readily respond to oscillations of these frequencies. If a radio frequency generator, therefore, radiates a wave of fundamental frequency  $f_1$ , and also harmonics of frequencies  $f_3, f_5$ , etc., it will be clear at once that this antenna will respond just as readily to the harmonics as to the fundamental, and consequently result in considerable interference, and inefficient reception of the fundamental wave. This last applies to the case where the fundamental and harmonics of the radio generator coincide with those of the antenna unloaded. The case of the loaded antenna, where these do not coincide, will be discussed later in this article.

By further consideration of the reactance curve, Fig. 5, it is seen that for frequencies below the fundamental  $f_1$  the reactance is negative. Therefore, since a condenser has a negative reactance, an antenna below its



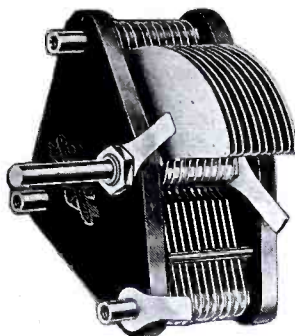

**ABC 21 Plate Condenser**

No. 650-21. 21 plates  
Capacity, .00055 Mfd.  
Price, \$3.75.

All ABC Condensers have "Condensite" heads for perfect insulation. This exclusive feature costs us more, but it's worth it.

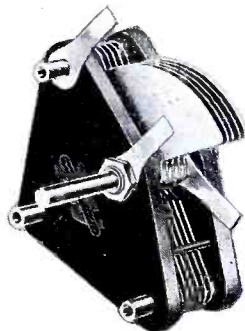

**ABC 11 Plate Condenser**

No. 650-11. 11 plates  
Capacity, .00028 Mfd.  
Price, \$3.00.

Automatic machine production makes every ABC condenser absolutely accurate, and every part instantly interchangeable.

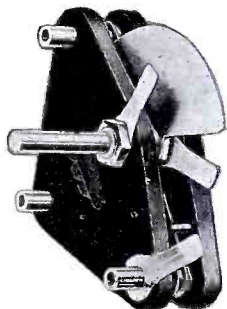

**ABC 3 Plate Condenser**

No. 650-3. 3 plates  
Capacity, .0001  
Price, \$2.25

This type is an excellent vernier condenser, for extremely sharp tuning, in connection with a larger condenser; or as a variable grid condenser.

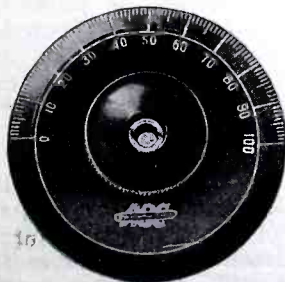

**ABC Brass Dials**

Condensers supplied with ABC Nickel-plated Brass Dials and composition knobs for 75 cents extra.

With Chelsea Knob and Dial, \$1.00 extra.  
ABC Knob and Dial Alone, \$1.00

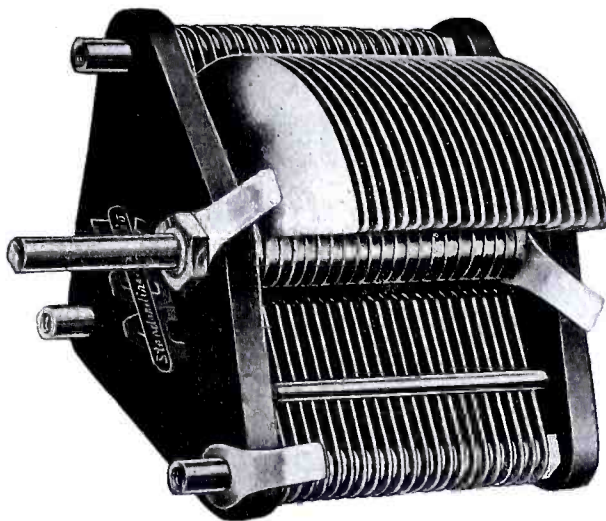

**ABC 43 Plate Condenser**

*One-half actual size*

No. 650-43.  
43 Plates.  
Capacity, .0011 Mfd.  
Price, \$5.00.

## These Nine Improvements Cost You No More—

**E**XAMINE these photographs carefully. Pick out the *nine features* that distinguish ABC condensers from any other make on the market: 1st, Sturdy plates,—.022 inch thick, that will not jar out of position: 2nd, Individual, *not cast* spacers, wide to prevent short circuiting: 3rd, Stop acts on *all* moving plates; 4th, One-piece shaft of brass, *not steel*, turned from solid brass rod: 5th, Shaft turns in solid brass bushing, which extends *thru* head: 6th, *Exclusive* Condensite head, the perfect insulator: 7th, Set screw (underneath) and locking lever for delicate friction adjustment: 8th, Easily mounted,—all studs *exactly* spaced: 9th, Minimum losses,—1¼-in. between opposite polarities.

Comparisons are difficult, because there never was a condenser so accurately made before. But compare these prices with the best condenser you ever used.

ABC condensers are *far lower in price* than any other condenser of similar quality. The automatic production that makes every ABC condenser alike, and every part interchangeable,—at the same time cuts manufacturing cost to a minimum. Materials are the finest obtainable, workmanship is unexcelled. Automatic production gives you *most value per dollar*.

# ABC VARIABLE CONDENSERS

Standardized Radio

Order direct from this advertisement. Your ABC condenser will be shipped at once in a specially designed carton that prevents any damage in the mail. It will arrive in perfect condition, ready for mounting without any adjustments, or loss of time. Also send ten cents for your copy of the new ABC 2-color catalogue, in handy pocket size, illustrating the complete ABC line of "Professional Radio Equipment at Amateur Prices." To insure immediate attention request "Catalogue CR 10."

**Wireless Equipment Co., Inc.**  
Newark, New Jersey

Just mail this coupon and one dime today to the Wireless Equipment Co., Inc., Newark, N. J., for your copy of the new ABC catalog, CR10.

Name .....

Address .....

City .....

State .....



# —to the Discriminating Radio Man

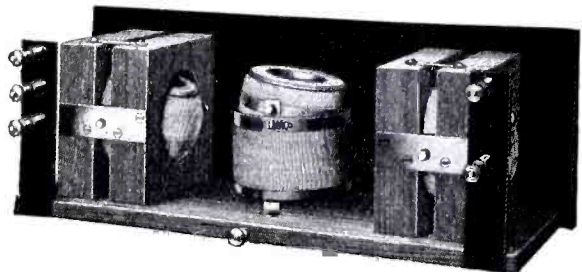

who insists on superior design, workmanship and performance, we unreservedly recommend this

## Telmaco Short Wave Receiver Unwired Type TR-1

In line with TELMACO'S policy of giving better values, we are offering the TR-1 set UNWIRED ONLY. The receiver is completely assembled; lugs are in place on which to solder wires; No. 14 silver finished wire, as well as necessary tubing is furnished.

The CABINET is constructed of quarter sawed oak, stained inside and out, waxed and hand rubbed. PANEL is of grade M 3/16 in. Formica, 6 3/4 in. x 16 3/4 in., satin grained finish, mounted on special drawer sub-base. Metal parts are nickel plated and oxidized. BINDING POST CONSTRUCTION is of TELMACO special design extending through back of cabinet, thus removing all external wiring from front of panel.

TELMACO VARIOMETERS and VARIO-COUPLER with flush type bearing plates and spring washer bearing contactors are used, thus assuring perfect electrical connections permanently for ball windings without "pig-tailing." DIALS are Remier 3 in. polished molded Bakelite. LETTERING on panel is pantograph machine engraved, filled with the best grade white enamel.

Order direct from this ad.

Satisfaction guaranteed always or money refunded. Send for our complete, new catalog "N." You'll find it interesting, it describes everything in Radio.

Your panels engraved with our GORTON ENGRAVER. Prices right.

DEALERS: We are distributors for nearly all Standard Lines.

Write for our Special Proposition.



Telmaco Short Wave Receiver, Unwired.....\$35.00  
Telmaco Short Wave Receiver and Detector Combined, Unwired...\$45.00

RADIO DIVISION

TELEPHONE MAINTENANCE COMPANY, 17 N. LaSalle St., Chicago, Ill.

## BANGERT ELECTRIC CO., Inc.

297 Fulton Street, Jamaica, N. Y.  
27 Main Street, Hempstead, L. I.

Dealers in Radio Sets and Supplies—All Popular Makes Radiotrons

### THE BIGGEST RADIO OFFER YOU EVER HEARD OF!

By special mutual arrangement between the publishers, the three big radio magazines of the country are made available for a limited time at a special rate when ordered together:

"Radio News", the newest and best-illustrated radio periodical in the world

"Pacific Radio News", pioneer journal of western radio development

"Q S T", devoted wholly to amateur communication and the official organ of the A. R. R. L.

ALL FOR ONE YEAR FOR

**\$5**

Don't miss this opportunity to secure the best contemporary radio literature of America coming to your door every month for a year—at a saving in real money, too. Send in your subscription today to

EXPERIMENTER PUBLISHING COMPANY, Inc.  
236 Fulton St. New York City  
Publishers of RADIO NEWS

## Wireless Amateurs ATTENTION!

If you want service, order from us. We carry a large stock of High Grade Wireless Apparatus of our own and other manufacturers.

### SPECIAL!

- Vacuum Tube Sockets.....\$1.25
- Rheostats ..... 1.25
- 22 1/2 Volt "B" Batteries..... 1.50
- Rasco Dials ..... .50
- Rubber Binding Posts..... .20
- Tested Galena ..... .40
- Lateral Wound Coils. All sizes.

Send 5c for our large illustrated catalog.

## J. M. PAQUIN

THE ELECTRICAL SHOP  
787 QUEEN ST. WEST  
TORONTO, ONT.

fundamental frequency behaves like a pure capacity. On the other hand, for frequencies above the fundamental, the reactance of the antenna is positive. Consequently for these frequencies the antenna behaves like an inductance.

In considering the case when the antenna is loaded, two cases arise: First, when the antenna is loaded by inductance; second, when it is loaded by capacity. These will be treated separately.

### INDUCTANCE LOADING

If an inductance coil of value L is inserted in series with the antenna lead-in, the natural period of the antenna will be considerably changed from its unloaded value. The reactance of this loading coil is 2 fL, and increases in direct proportion with the frequency. Thus its characteristic curve will be a straight line, shown dotted in Fig. 7, having a positive slope. The reactance curve of the antenna is the usual cotangent curve shown in light lines. The sum of these two reactance curves gives the resultant reactance curve of the loaded antenna, shown in the heavy lined curves, which are seen to be no longer sym-

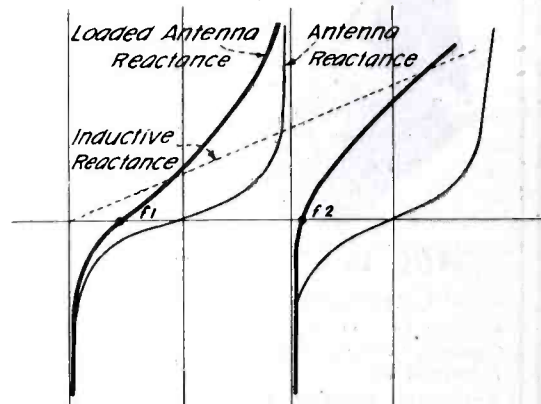

Fig. 7

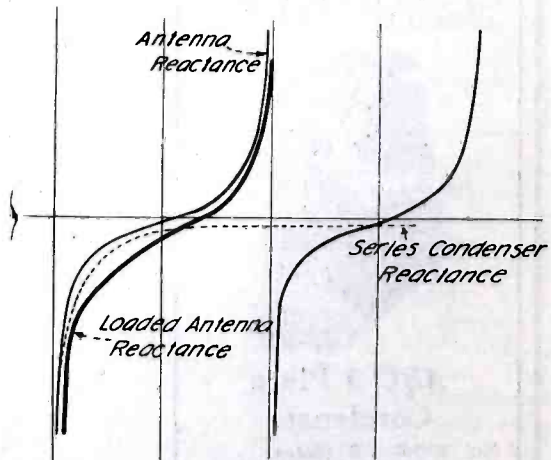

Fig. 8

Characteristic Curves of Loaded and Unloaded Aerials.

metrical, as the cotangent curves are. At certain definite frequencies, as f1 and f2 in Fig. 7, the positive inductive reactance exactly equals the negative antenna (unloaded) reactance, consequently at these frequencies the total antenna reactance is zero. These frequencies are, therefore, the natural frequencies of oscillation of the loaded antenna. It should be observed that, unlike the unloaded antenna, the harmonic frequencies are not exact odd multiples of the fundamental frequency. Furthermore it will be seen that with inductance loading, the point of zero reactance is moved to the left, that, therefore, the natural frequency of the loaded antenna is lower than that of the unloaded antenna, in other words, the wave-length is increased.

The fact that with an inductively loaded antenna the harmonic oscillations are not exact multiples of the fundamental, is of some importance in the problem of interference. It is possible that while receiving



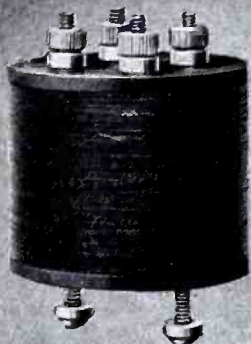

**FIRCO SACO-CLAD**  
amplifying transformer

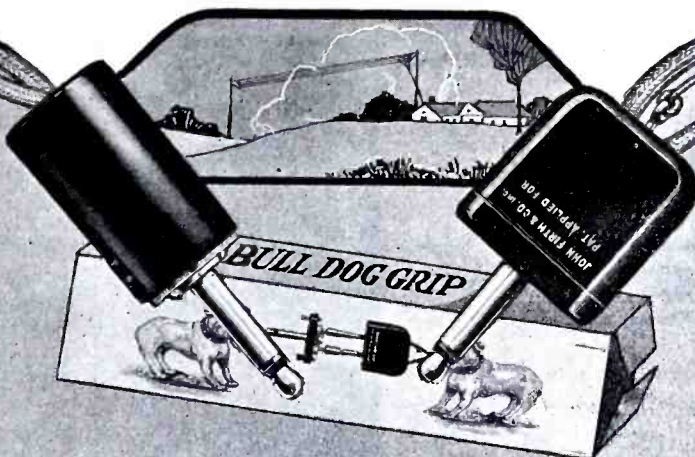

# FIRCO RADIO EQUIPMENT



**FIRCO VOCALOUD**  
Station Type

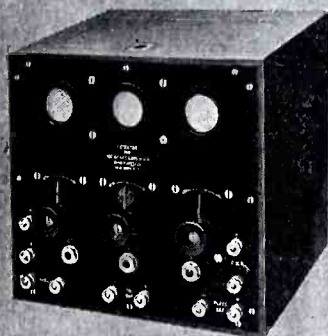

**FIRCO STANDARD**  
Detector and 2-Step



HERE might be a full page ad devoted to every instrument on this page. But the actual apparatus is far more convincing than anything we could say. So we simply refer you to your dealer. He has our elaborate loose-leaf catalogue, and will gladly obtain any instrument you ask for. In fairness to yourself, insist on examining Firco instruments before you buy.

**Firco Saco Clads**  
(Patent applied for thruout the world.)

100% shielded. No magnetic leakage, and no howling even with six steps. Price, in individual cartons, \$5.00.

**Firco Standard Apparatus**  
Equal to apparatus supplied to the Government. Solid mahogany cabinets. One to six-step amplifiers. Detector and two-step, shown, \$75.00.

**Firco Audion Sockets**  
3/4" Bakelite base, nicked brass tube, wide phosphor bronze contacts, and other exclusive features. Unequaled value. Single, \$1.10; Double, \$2.30; Triple, \$3.50.

**Brown Phones**  
Standard of Great Britain and Europe. Ultra-sensitive, 4000 ohms. Weight only 10 ounces. Reduced in price. Type A, adjustable, \$18.00, was \$22.00; Type D, for phone work, \$16.00 was \$20.00.

**Imported Seibt Phones,**  
2000 ohms, \$7.75.

Leaflet describing any one instrument, sent for your dealer's name and 2 cents. Loose-leaf catalogue, 25 cents.

**Vocaloud**

This clear-toned loud speaker is proving the sensation of 1921 radio. No batteries, no adjustments, no extra equipment. Station type, in polished mahogany cabinet, as shown, \$30.00; Laboratory type, mounted on adjustable base, \$25.00.

**Firco Midget Units**

Quality equal to Standard Apparatus, but greatly simplified. Set of three units (Tuner, detector and 2-step), \$58.00; Tuner, \$15.00; Detector, \$11.00 and other units at equally reasonable prices.

**Firco-Eldredge Meters**

All nickel plated flush type. 600 volt meter, with multiplier, \$14.00. Other ranges, moderate prices.

**Firco "Bull-Dog-Grip**

Interchangeable Telephone Plug. Insert or remove any standard cord tip in 10 seconds. Then, "The harder you pull, the tighter it grips." Type 34A, flat, \$2.00; Type 34B, round, \$2.50.



**FIRCO MIDGET UNITS**  
(Tuner, detector and 2-step, \$56.00)

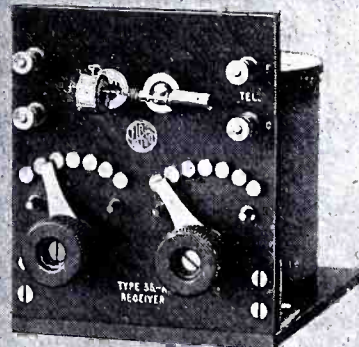

**FIRCO MIDGET**  
receiving UNIT



**FIRCO VACUUM**  
TUBE SOCKETS



**IMPORTED BROWN**  
supersensitive PHONES

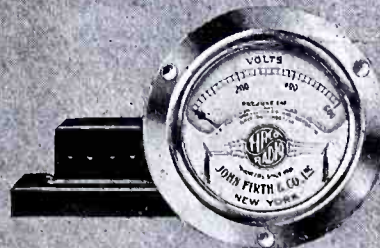

**FIRCO 600**  
Volt METER



**John Firth & Company, Inc.**  
18 Broadway New York  
"Pioneers Since 1901"

To eliminate excessive advertising expense, which you as the buyer would eventually pay, we show a number of new instruments and types of apparatus on this single page. Practically every radio dealer in America has FIRCO apparatus in stock, or the FIRCO dealer's catalogue, and in most

cases he would prefer to sell you FIRCO Radio Equipment to all others. Go to your radio dealer and ask for the FIRCO products shown on this page. He is waiting to explain in detail the superiorities simply mentioned here.

JOHN FIRTH & CO., Inc.



# STAND HARDEST USE

Brandes Headsets are made of such good material; so well made; so scientifically designed and constructed; so mechanically perfect in every detail—that they stand the hardest use and give long-time service of the highest efficiency.

In professional, scientific and amateur use all over the world. Proving satisfactory under all conditions.

"Navy" type headset . . . . . \$14.00  
 "Superior" type headset . . . \$ 8.00

Sold on 10 days' trial. Money refunded if not satisfactory. Send 5c for Catalog G. DEALERS, Write for Proposition.

C. BRANDES, INC.  
 Room 823, 32 Union Sq., N. Y. City



## BRANDES Matched-Tone HEADSETS

### INSTRUMENTS BUILT for SERVICE

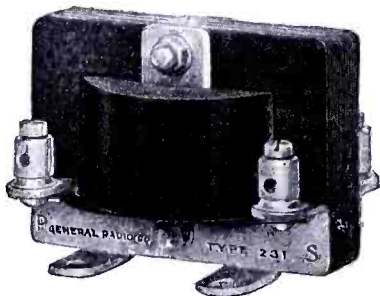

A vacuum tube filament rheostat must be more than a mere current regulator. It must be an instrument mechanically and electrically perfect. To eliminate tube noises, the switch blade must take smooth and positive contact.

Our Type 214 Rheostat is made exactly for this severe service. It is made in several sizes, for receiving tubes, for 5 watt transmitting tubes, for grid biasing, and is made for front of panel or back of panel mounting.

FILAMENT RHEOSTATS, PRICE, \$2.50

SEND FOR FREE RADIO BULLETIN 909N

## GENERAL RADIO COMPANY

MASSACHUSETTS AVENUE AND WINDSOR STREET

CAMBRIDGE 39

MASSACHUSETTS

Standardize on General Radio Equipment Throughout.

CARRIED BY LEADING DEALERS

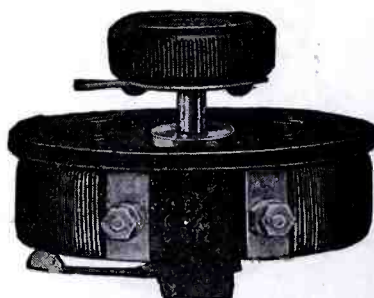

While in itself a small instrument, the amplifying transformer plays a large part in the results obtained by a receiving set. You would not connect a garden hose nozzle to a fire hose. So why connect an inefficient amplifying transformer in your receiving set?

Our Type 231 amplifying transformer is the result of careful engineering study to obtain an instrument which would give the maximum of results with a Radiotron UV201 tube. In addition to its superior electrical characteristics, this transformer is well designed mechanically. It is rugged. The binding posts and mounting brackets are accessible. And finally, the price is right.

PRICE, COMPLETELY MOUNTED, \$5.00

on the fundamental frequency  $f_1$ , an external arc generator may be radiating a harmonic near that of the loaded antenna. In spite of the antenna being tuned to the fundamental, this harmonic oscillation will be reinforced, since it is seen that the antenna reactance is zero at this frequency; considerable energy is thereby wasted and interference is created.

#### CAPACITY LOADING

Just as inductance loading alters the fundamental of the antenna, so does capacity loading affect it in the same way. The reactance of a condenser varies inversely as the frequency, consequently its reactance curve is of hyperbolic form as shown in the dotted curve of Fig. 8. When added to the cotangent reactance curve of the unloaded antenna, the resultant reactance curve shown in the heavy line is obtained. Here it is also seen that the fundamental and harmonics are not exact multiples of each other, and that the natural frequency of a capacity loaded antenna is greater than that unloaded, in other words, the effect of a capacity in series with an antenna is to decrease its fundamental wave-length.

In speaking of the resistance of the antenna one generally has in mind the total effective resistance of the antenna. This is made up of the following:

1. Ohmic resistance of the antenna wires, ground, lead-in, which results in energy being used up in the form of heat.
2. Dielectric losses in the dielectric of the antenna-ground condenser. This is generally a very poor dielectric, and depends also, to a large extent, upon surrounding objects. Thus, high buildings, masts, trees, etc., result in increasing these losses and adding to the effective resistance of the antenna.
3. Radiation losses: The antenna being designed to radiate energy, this dissipation of energy is the useful power. Since this radiated energy is proportional to the square of the current, we may regard it as due to a so-called "radiation resistance." The greater this "radiation resistance," the more efficient is our antenna.

These go to make up the total resistance of the antenna. The object in antenna design is, therefore, to decrease as far as possible the first two factors and increase to a maximum the last factor.

Each of the constants so discussed, namely capacity, inductance and resistance, is capable of being accurately measured and the best methods for doing this will be considered in detail in a later article.

#### Show Your Goods

(Continued from Page 289.)

the long run.

At winter resorts and summer resorts radio dealers will find plenty of chances to show their goods. These places are usually frequented by well-to-do people. They have time on their hands. They are always looking for something new. The only summer resort radio I happened to see last summer was the roller chair outfit on the boardwalk at Asbury. It seemed to be doing a good business at fifteen cents a listen. I wondered why the proprietor did not have a set around somewhere to sell to the inquiring visitor. Seems as though a set a day ought to be well within the sales possibilities of a location like that.

It ought to be possible to show off a portable set on a railway train. Radio dealers travel. To pay a little extra, get into the Pullman with a lot of prospects and pose as an experimenter, is permissible advertising. There would be plenty of openings for selling talk. Many a man loses enough playing poker on the way from New York to Chicago to buy a "peach" of a set. On a steamer trip, the job would be easier still. A well-located room with the door open and the set working would



# FADA RHEOSTATS <sup>A</sup><sub>N</sub><sup>D</sup> SWITCHES

are designed "right" and put together "better" than all others. Purchase them from your dealer or direct and assemble your own instruments. The knob, inductance switch and series-parallel switch is "new," and the panel mounting rheostat improved. A beautiful catalog of these and all other FADA radio supplies will be mailed for a dime. Send your order to-day for these necessary parts and get your set ready for winter traffic work.



**FADA  
BINDING POST**

Without question the best appearing binding post on the market. Dia. of knurled non-removable top  $\frac{1}{2}$ ". Shank threaded 6-32. Each.....\$0.15



*Above*—INDUCTANCE SWITCH



**FADA  
THERMOPLAX KNOB**

The new FADA Thermoplax knob that will stand heat up to 600 F.  $1\frac{1}{4}$ " dia. at bottom and 1" at top.  $\frac{3}{4}$ " high. Brass insert threaded 8-32.....\$0.20

**FADA  
INDUCTANCE SWITCH**

A new switch that can be easily assembled, that is smooth in its movement, and most reasonably priced. Uses the FADA Thermoplax knob and the switch lever is pinned to the knob. The radius of the lever is  $1\frac{1}{4}$ ". For panels  $\frac{1}{8}$ " to  $\frac{3}{8}$ " thick. Use a switch point  $\frac{1}{4}$ " in dia. and  $\frac{1}{16}$ " high. Complete as in illustration, each.....\$0.50

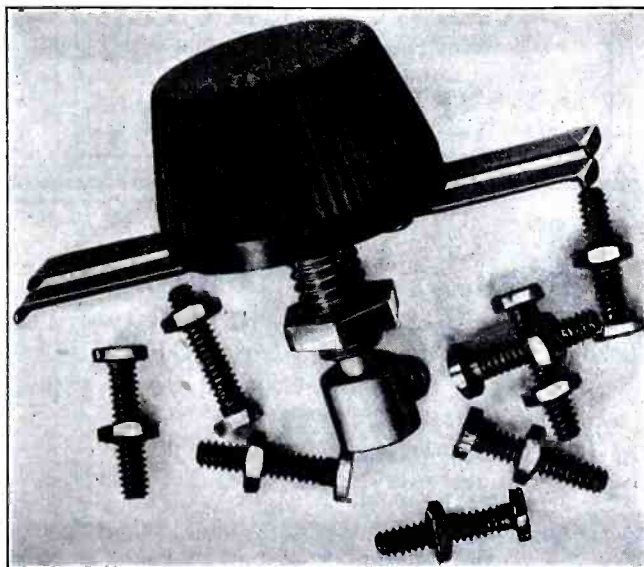

**FADA <sup>PANEL MOUNTING</sup> RHEOSTAT**

**FADA  
SERIES-PARALLEL SWITCH**

Series-parallel switches can be used in hundreds of ways. This FADA switch has a blade radius of  $1\frac{1}{4}$ ". The FADA Thermoplax knob is a feature. Blades are fastened to the knob by machine screws. Blades nicked and polished.

Switch alone, each.....\$0.75  
Switch complete with 8 switch points and two stops, each.\$1.00

The popular FADA panel mounting rheostat has been improved and the price left at \$1.25. Now furnished with a FADA Thermoplax knob and a pointer having a radius of only 1" instead of  $1\frac{1}{4}$ " as before. To protect yourself against imitations look for the FADA trade-mark as the genuine FADA rheostat is the only one made with a Thermoplax base and knob. The price is only.....\$1.25

DEALERS: Write for information about FADA supplies. You can't lose money selling FADA parts—sales prove it.

**F.A.D. ANDREA**

Manufacturer of FADA Radio Products

1882-A JEROME AVE.  
NEW YORK CITY

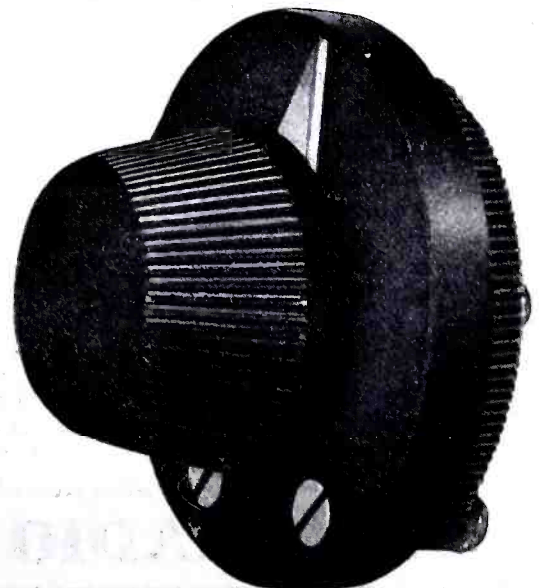







idea. A professional vaudeville actor would have no difficulty in learning to operate apparatus set up and cared for by a partner who was a radio man. Of course, there would be a line on the program: "Apparatus furnished by Interplantarian Radio Co."

There are thousands of schools where radio demonstrations should be given. They would be doubly welcomed by the physics teachers, many of whom have never seen a real set. Every school ought to have a set and most would have them if a real salesman would show principal, teachers and school boards the many links that would bind radio to the curriculum. There are some good precedents already established—Chicago, for instance—where the high schools have gone into radio in a big and broad way.

Last summer a manual training teacher listened in with me through a whole long evening. Between calls he always had a new suggestion as to how radio could coordinate with his work. The pupils could make panels, bases, and even build complete sets in school, he said.

In the homes of people who can afford the best in radio apparatus, there are frequent social gatherings in which radio could play a part. A dealer should feel no hesitation in suggesting to the social leaders that he could provide a radio evening. As at the convention, the radio telephone butting in at intervals with some pat observation or a bit of "jazz" could make quite a reputation for itself. As a more serious feature, lights could be dimmed and a map of the nearest coast illuminated, with cardboard models of various ships attached at approximate positions to those ships. Signals from a number of these vessels might be brought in and as much of the nature of the contents divulged as could be repeated without violation of the law concerning secrecy. The communication of ship with ship at sea is still a dramatic incident to most people.

There are several classes of people who ought to be covered at once, in their homes, studios or offices, by competent radio demonstrators. First, the editors. They can do more to help or hinder radio than any other one class that I know. Most of them at present seem to think that radio is outside of their sphere. The newspaper editors take radio news items, of course, often with the glaring inaccuracies of cub reporters.

A family journal whose name has been a household word for nearly a century was still refusing, the last I knew, to include radio and moving pictures in its plans. The fact that it is beginning to be looked upon as decadent by experienced magazine men seems to have little influence with the management, for one thing this publication has always stood for its ideals, let profits come or go. Why has no broad-minded radio dealer ever brought to bear upon the editorial staff of this periodical the sound educational and moral arguments for radio?

No matter how much time is required, it would be worth while for a dealer to arrange for demonstrations in all the editorial offices in his territory or gather the editors where sociability could assist in putting the demonstration across. I have entertained half a dozen editors at my station, and I know it is worth while.

Authors should be shown the broad outlines and present status of radio also. They turn out the copy that editors and book publishers buy. Any author who could not find something in radio wherewith to embellish a story would be blind indeed. To the professional writer, new ideas have great value. A radio dealer who would suggest an interesting radio plot or incident to a short-story writer, a play-wright, a cartoonist or a cover designer would be

# Arcs and Tubes

**These new branches of the revised examination of the Department of Commerce are fully covered in the Home Study Course of the Radio Institute of America.**

The Home Study Course will thoroughly equip you for the new examinations of the Department of Commerce, which went into effect July 1 of this year, and by enrolling for this course you will be taking a big step in the right direction and insuring your future. The ever-broadening field of radio communication offers every opportunity for future security and the job is usually looking for the capable ambitious man.

Enrollments are coming in by every mail. Why aren't you one of the wideawake wireless men who have seen the new and greater opportunity opened to them by the Home Study Course, which is specially designed to land them one of the enviable jobs at the world's greatest radio station? NOW—not some later day—is the time to act!

Consider, for instance, the opportunities of the "Promised Land."

"The Promised Land" is the name professional operators have given to the New York Radio Central Station, on Long Island. When completed, this station will be the largest and most powerful radio station in the world.

It will be equipped to work simultaneously with five other nations in widely separated and distant parts of the world, and will be epoch-making in the field of international communication.

A position at this station is the height of every operator's ambition, for it means unlimited opportunity to succeed and progress to higher, more responsible and better paying positions in the radio industry. So far as opportunity goes

the successful future of these men is assured.

How about you?

This new home course of radio training, which has been developed for the benefit of those who cannot attend the Institute personally, is the same course used at the Institute. It includes everything from basic principles of electricity and magnetism to actual operation of commercial radio equipment, including arc and tube transmitters. It also includes the same textbooks used in the Institute classes, as well as a buzzer set of greatly improved design with a variable automatic transmitter for code practice.

The graduates of the Radio Institute of America enjoy a great and exclusive advantage in the close connection existing between the Institute and the Radio Corporation of America, the world's largest radio manufacturing and commercial radio company.

Prominent executives in the radio field are former students of the Institute. The Radio Corporation employs thousands of men, in its executive departments, on ships and at shore stations and in factories and laboratories. A large percentage of these men are graduates of the Institute.

The Radio Institute of America has been an established and successful institution for over fifteen years. The year round average attendance in its classrooms is now 298 students per month. It has trained over 6,000 men, 95% of whom have successfully engaged in this new branch of science and industry.

You, too, can be successful in this new field if you properly train yourself by means of the Home Study Course of the Institute. Radio offers an unlimited opportunity for future advancement—why not take advantage of it? Write for our booklet and further details—*Now*.

HOME STUDY DIVISION

## Radio Institute of America

(formerly Marconi Institute)

### 324 Broadway, New York



## Commercial Type Wired and Unwired Instruments



*Detector and 2 Stage Amplifier*

Prices F.O.B. New York  
 Commercial Type, wired.....\$65.00  
 Commercial Type, unwired..... 55.00  
 Amateur Type, wired..... 57.00  
 Amateur Type, unwired..... 47.00

This is another of the many popular designs of STANDARD instruments that have been available only for commercial and government station work. It is assembled from materials heretofore believed too costly for use in instruments intended for sale to experimenters. The new style Radiotron UV-712 transformers of General Electric make are but one of the features incorporated in this excellent instrument.

Sold both wired and unwired, and also in the Amateur Type, which is an exact duplicate of the more costly instrument except that transformers and tube receptacles of high efficiency but lower cost are used.

This, or any other STANDARD instrument will be shipped to any part of the United States on receipt of a deposit of one-third the list price. Examine the instrument and if you then wish to purchase it remit the balance, if not return it and we will refund your money, after deducting carrying charges.

Send stamp for descriptive literature.

### STANDARD ASSEMBLING COMPANY

19 BRIDGE STREET

Dept. RN-2

NEW YORK

TRADE **ESCO** MARK

GENERATORS—MOTOR-GENERATORS—DYNAMOTORS

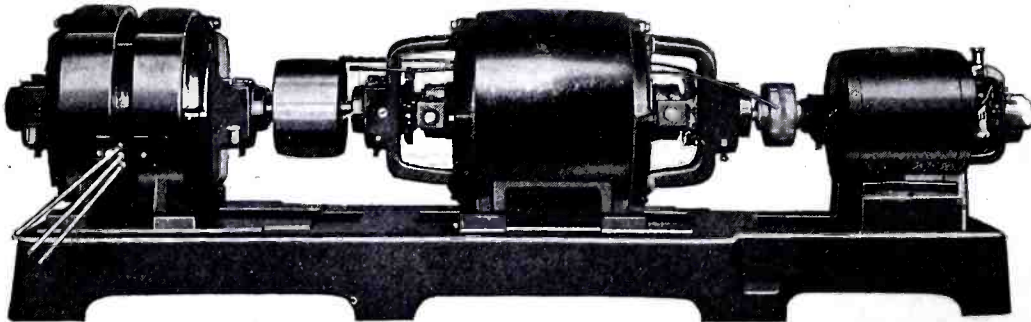

4 to 32 Volts for Filament—350 to 2000 Volts for Plate.  
 Capacity 20 to 2000 Watts—Liberal Ratings.  
 Write for Bulletin 237 which lists over 200 Combinations.

**MOTORS AND GENERATORS DEVELOPED  
 FOR SPECIAL PURPOSES**

*PIONEERS IN MANUFACTURING*

High Voltage Direct Current Radio Generators

**ELECTRIC SPECIALTY CO.**

STAMFORD, CONN., U. S. A.

211 South Street



sure of an appreciative response. If the suggestions were accompanied by an invitation to look at and operate and get the "feel" of radio apparatus, it would be almost sure to result in getting radio before the general public in a most effective way.

The writers and publishers of school and college text books ought to be shown what radio can do. An examination of the physics text books shows that many now in use contain only the ancient history of radio. Just a suggestion to author and publisher would ensure the next editions being brought up to date. Show them modern apparatus and let them operate it and you will find that the space given to radio will expand.

The writers and publishers of school readers would grab at radio stories showing the grade pupils how they can build apparatus and become operators. Here is a chance to plant some seed in the most fertile soil. It would produce a whole generation of radio bugs.

The moving picture producers are always anxiously searching for new ideas, new plots. They pay big salaries to people who read books and write synopses; to writers who take the synopses and develop them into scenarios; to continuity writers, editors, directors, and the whole enormous staff of people employed in getting a picture onto the screen in thousands of theatres throughout the world. There ought to be radio demonstrations in every movie settlement. Last year I suggested to several movie publicity directors that an educational film showing how radio works would be interesting. Not long ago a boy described to me most enthusiastically a picture produced on the lines which I had suggested.

Lately I have noticed that the Magnavox is being used by phonograph dealers for attracting people who are passing in busy and noisy streets. It struck me that radio dealers ought to be projecting signals into the street by the same method or some other. A busy loud speaker which would announce occasionally: "These signals are coming from the Eiffel Tower in Paris," and so on, would keep a crowd looking at the window display, which could show them how much easier it would be to sit at home and listen to the Frenchmen than to stand on the street with the mob.

Any progressive newspaper publisher would see the advantage of having such apparatus installed beside his bulletin board.

An auto dealer could get a lot of good publicity out of a stunt like that pulled off by Roy A. Weagant of radio fame. He brought in signals from POZ strong enough to operate a relay and hooked up a claxon horn as a loud speaker. When the squawk box started at thirty words per, the knowledge of radio spread very rapidly in that neighborhood.

In August I spent some time in one of the very best places for demonstrating radio apparatus—the largest group of boys' camps in the world. It is in the Palisades Interstate Park and has an average attendance of more than two thousand Boy Scouts during a ten weeks' season.

When I arrived, with a commercial operator who was also a radio amateur and a Scout, we found a dozen radio sets in as many camps practically out of commission for the lack of something to do. Much of the apparatus was up-to-date stuff like the Paragon RA-10. I took my Grebe CR-7 along to bring in press and European stations.

It took only a few days to get a schedule going and to line things up so that application could be made for licenses, and inter-camp communication established. The wireless bulletins posted at the general headquarters not only interested Scouts and Scout officials, but also caught the atten-



# THE POWER RATINGS OF MAGNAVOX RADIO LOUD SPEAKERS

Magnavox electrodynamic receivers are limited only by their construction and electrical constants in the amount of power they will convert into sound. Therefore we have rated them according to the input they can receive and successfully turn into sound—either from signals or from radio telephone speech or music.

This also means that with their rated input the Type R-3 may be heard  $\frac{1}{2}$  mile under good conditions, and the Type R-2 be heard  $1\frac{1}{2}$  miles under the same conditions.

The way to get a POWER input to utilize the enormous converting characteristics of Magnavox is to use from 100 to 500 volts on the plate of your two-stage amplifier—then you will hear your signals with a strength not approached by any other type.

**CAUTION.**—Do not use 4 or more stages of amplification, use only two or three with high plate voltage and be careful that you do not put your phones or loudspeakers made from phones in the output circuit, for you will surely burn them out. You need have no fear of even 750 volts for the Magnavox as they will carry it successfully.

The Type R-3 Radio Magnavox is a 5 Watt Instrument at . . . \$ 45

The Type R-2 Radio Telemegafone is a 20 Watt Instrument at \$110

## THE MAGNAVOX COMPANY

OAKLAND, CALIFORNIA

370 7th Ave., NEW YORK CITY

# FEDERAL C. W. APPARATUS

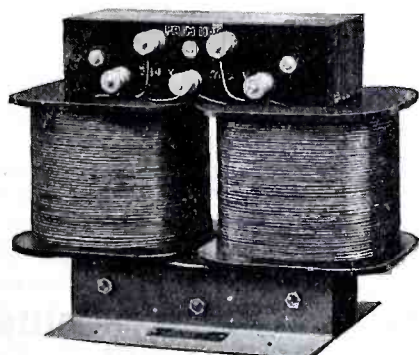

No. 315-W

### Combination Power Transformer

500 Watt C-W Power Combination Transformer. To economically replace the motor generator. In addition to the 500 volt supply, two other current supplies are provided for filament heating. (A) 12 volt supply for rectifier filaments; (B) 12 volt supply for transmitter tube filaments.

Price in U. S. A. \$32.00

### Modulation Transformer

Modulation Transformer is designed particularly for Grid Modulation for use in connection with Federal Microphones to properly modulate the voice frequencies and produce clear speech.

Price in U. S. A. \$7.00

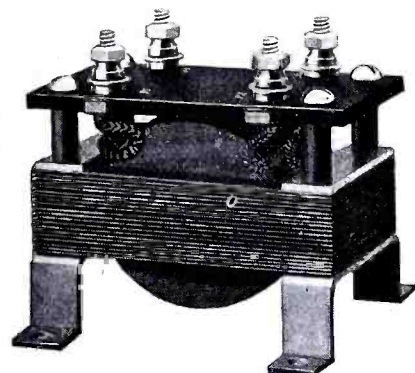

No. 236-W

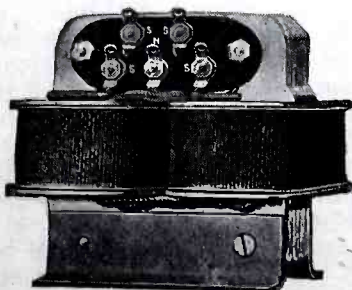

No. 311-W

### Filament Lighting Transformer

150 Watt Filament Lighting Transformer is used to take the place of a storage battery and will furnish a steady current supply for the standard transmitter and rectifier tube filaments.

Price in U. S. A. \$15.00

### 2.5 Henry Filter Coil

800 M. A. Filtercoil is of high impedance value for A. C. and a negligible resistance to D. C. Its use is to smooth out the pulsations in the D. C. Current, to keep the direct constant when modulating and to prevent the high frequency backing into the generator or power transformer. It is the double coil type.

Price in U. S. A. \$7.50

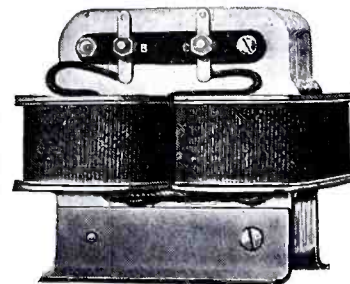

No. 300-W

Write for Bulletin 103-W.B. describing latest C.W. and Spark Transmitting Equipment Receiving Apparatus and parts. Amplifying Transformers, Head Telephones, Pluophono, Variable Condensers, Anti Capacity Switches, Filament Control Jacks and Plugs, Etc.

Ask your dealer for Federal equipment if he does not have them tell us his name.

**Federal Telephone & Telegraph Co.,**

1738 Elmwood Avenue  
Buffalo, N. Y.



# LEARN WIRELESS AT HOME

The Demand for Good Wireless Operators Far Exceeds the Supply

The New York Wireless Institute will make you an operator—AT HOME—in your spare time—quickly, easily and thoroughly. No previous training or experience required. Our Home Study Course has been prepared by Radio Experts. Experts able to impart their practical and technical knowledge to YOU in an easy to understand way. The graded lessons mailed you will prove so fascinating that you will be eager for the next one. The instruments furnished free, will make it as easy to learn the Code as it was to learn to talk. All you will have to do, is to listen.

### TRAVEL THE WORLD OVER

A Wireless Operator can visit all parts of the world and receive fine pay and maintenance at the same time. Do you prefer a steady position without travel? There are many opportunities at the numerous land stations or with the Commercial Wireless or Steamship Companies.



FREE INSTRUMENTS AND TEXT BOOKS

This wonderful Set for learning the Code furnished FREE with our Course

We furnish free to all students, during the course, the wonderful receiving and sending set exactly as produced in the illustration. This set is not loaned, but GIVEN to all students completing the Course.

The Transmitter shown is the celebrated Omnigraph used by several Departments of the U. S. Government and by the leading Universities, Colleges, Technical and Telegraph Schools throughout the U. S. and Canada. Start the Omnigraph, place the phone to your ear and this remarkable invention will send you Wireless Messages, the same as though you were receiving them, through the air, from a Wireless Station hundreds of miles away. When you apply for your license, the U. S. Government will test you with the Omnigraph—the same model Omnigraph as we furnish to our students. Ask any U. S. Radio Inspector to verify this.

### FREE Post-Graduate Course

A one month's Post-Graduate Course, if you so desire, at one of the largest Wireless Schools in N. Y. City, New York—the Wonder City—the largest port in the World and the Headquarters of every leading Wireless and Steamship Company.

### BIG SALARIES

Wireless operators receive salaries from \$125 to \$200 a month and it is only a stepping stone to better positions. There is practically no limit to your earning power. Men who but yesterday were Wireless Operators are now holding positions as Radio Engineers, Radio Inspectors, Radio Salesmen at salaries up to \$5,000 a year.

### EASY PAYMENTS

A small payment down will enroll you. We will make the payments so easy that anyone ambitious to enter the fastest growing profession—Wireless—may do so.

### Send for FREE Booklet

Without obligating you in any way, send for our booklet "How to Become an Expert Wireless Operator"—it is free. Mail the coupon below, or postal or better—but do it today.

NEW YORK WIRELESS INSTITUTE  
Dept. 228, 258 Broadway, New York City

NEW YORK WIRELESS INSTITUTE  
Dept. 228, 258 Broadway, New York City

Send me, free of charge, your booklet "How to Become an Expert Wireless Operator," containing full particulars of your Course, including your Free Instrument offer.

Name .....

Address .....

City or Town..... State.....



## Tresco Tuners are Complete

No Loading Coils are Needed

USED ALL OVER THE WORLD

- 5000 to 20000 M.....\$10.00 add P. P. Type B.S.
  - 700 to 5000 M..... 10.00 add P. P. Type A.S.
  - 200 to 700 M..... 10.00 add P. P. Type C.S.
- Coils of either for panels \$5.00 plus P. P.

### Knocked-Down Panels for Our Tuners—Set Them Up and Save Money

Consists of Formica Panel—drilled ready for parts, 1 Rheostat—one 11 Plate condenser, H.V. switches, points, base and necessary binding Posts. V.T. socket \$1.00 extra. Shipping weight, 4 lbs. Price, \$6.00. Add Parcel Post.

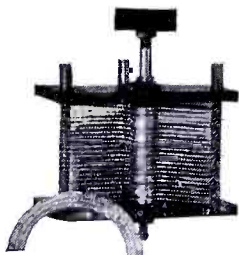

### KNOCKED DOWN CONDENSERS

- Assemble and save money.
- 11 Plate ..... \$1.80
  - 21 Plate ..... 2.25
  - 41 Plate ..... 3.20
- Add P. P.

- Filament Rheostats ..... \$1.25
- 5. Watt Tube ..... 1.50
- Switches, our type ..... .60
- Switch Points, doz..... .45

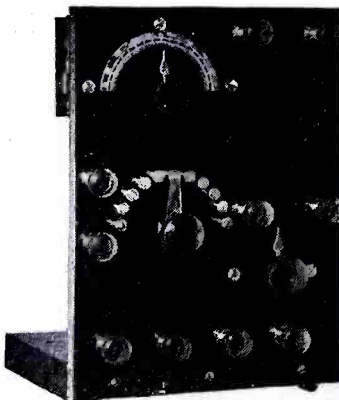

### TRESCO BINDING POST

H.R.Top, Polished Nickle Base, as cut, \$1 for 10 of them. Add P. P. The best made for your panels.

Dealers in Every City

TEL-ELECTRIC CO., HOUSTON, TEXAS—DISTRIBUTOR FOR SOUTHWEST

10c Brings Wonder Catalog of 24 Pages

## TRESCO - DAVENPORT - IOWA

Insure your copy reaching you each month. Subscribe to Radio News—\$2.00 a year. Experimenter Pub. Co., 236-A Fulton St., N. Y. C.

tion of thousands of visitors, who stopped to look at the Scout museum. The headquarters radio station, perched high above the exhibits, came in for its full share of attention.

If some dealer had seen his opportunity and instead of laying off a salesman had offered his services to this camp for the summer he could have made a notable contribution to Scouting and at the same time attracted a lot of business. The Boy Scouts of America organization is particularly keen about discouraging attempts to use its prestige for commercial purposes, but in perfectly proper ways a dealer could have built up a valuable clientele.

This is but one of the lost opportunities which gives rise to the complaint "Business is dull." There were 200,000 Scouts under canvas this summer in thousands of camps.

Last year a dealer gave a demonstration at the National Conference of Boy Scout Executives. He has expressed some dissatisfaction at the results, and it may be justified. But I know of \$300 which he took in immediately afterward as a direct result of the demonstration. Also, I know that 45 of the men who saw the demonstration have arranged for radio service at their own headquarters, that about 400 amateur operators have since been registered with the Navy Radio Amateur Bureau through Scout headquarters and that one Scout center—Harrisburg, Pennsylvania—is reported to be installing an outfit at an expense of \$700. These are only beginnings.

How far a dealer can go in showing his goods, it is for him to decide. There are ministers who maintain that as long as they preach the gospel they are doing God's will, even though the pews be empty. I do not say that they are wrong. Neither am I in a position to argue with the radio dealer who spends his time altogether in trying to get people to come to him to see his goods, but I have noticed that neither empty churches nor empty radio stores last as long as those that go after business.

People see and buy things that are associated in their minds with pleasurable experiences. When my wife and I walk down the street with a kid by our side the kid can smell a candy store ten blocks away. Wife gets out of phase every time we pass a millinery or house-furnishings window. Me—I am awakened by and by, by a gentle tug at my sleeve and find my nose flattened by long contact with a plate glass window which insulates me from a lot of radio dinguses and saves me from grand larceny.

A long time ago a fellow had to show me his goods, but now all he has to show me is how to get the price.

### Relay Keys for Transmitters Up to 1 K.W.

(Continued from Page 298.)

key in circuit with a battery, the armature A, attached to an aluminum lever, L, in these sounders, is attracted to the magnets downward; and when the main hand key is not depressed, leaving the magnet circuit open, the armature A is released from the magnets and drawn upwards by the spring S. If, in place of the stops used on the sounders at C in Fig. 1, key contacts are used, a relay key will be formed.

The key contacts are shown in detail in Figs. 3 and 4, the former being the lower contact, the latter being the upper movable contact. In both contacts, from the line AA and below, the material of the contacts is brass. On the surfaces AA, a sheet of  $\frac{1}{32}$ " silver is brazed in the usual manner, this surface of silver being the actual key contact surface. Silver is by far the very best material to use for the key contact surface, just as it is the best material to



# For Radio Panels



## Waterproof Fibre Insulation

Hard fibre is the toughest dielectric known. Add to Diamond Hard Fibre the commanding quality of water-resistance and the combination produces Condensite Celoron—the last word in electrical insulation.

This remarkable material marks a new era in the wireless world. In addition to being waterproof, high in dielectric strength and light in weight, Condensite Celoron is insoluble, infusible and immune to the effects of climatic or atmospheric change. Read this Bureau of Standard test:

Wave Length Meters	Approximate Frequency Cycles per second	Phase Difference Degrees	Dielectric Constant-K
373	804,000	2.0	4.7
1,295	231,500	1.8	4.8
3,067	97,800	1.8	4.9

We supply Condensite Celoron in standard size sheets, rods and tubes ready for all machining purposes—for experts and amateurs. Sold by radio equipment dealers everywhere. If your dealer cannot supply you, write us.

### Diamond State Fibre Company

Bridgeport (near Philadelphia), Penna.

Branch Factory and Warehouse, CHICAGO

Offices in principal cities.

In Canada: Diamond State Fibre Co. of Canada, Ltd., Toronto

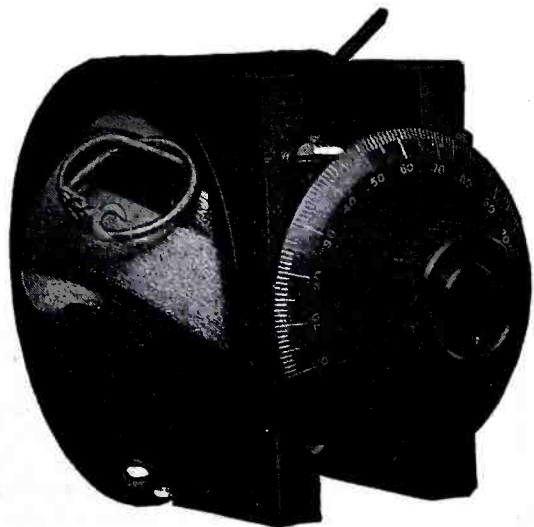

### The Variometer

The now famous Z. R. V. Variometer has met with a tremendous sale to *thousands* of discriminating purchasers who know the quality of Clapp-Eastham products.

Complete with knob and dial .. \$6.50  
 Complete without knob & dial 5.75  
 Variocoupler to match, with knob and dial ..... 7.50

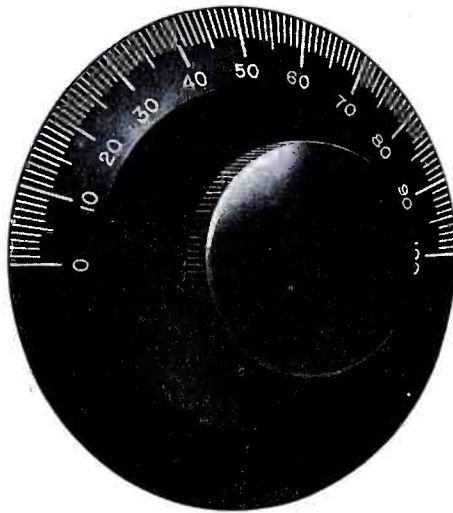

### The Dial

This 3" knob and dial is our own product, heavy brass dial, black oxidized finish, composition knob 1 3/8" diameter. Supplied for 1/8" shaft only. This dial can not chip or warp and *will run true*. Its beauty is in keeping with the best products of the instrument maker.

Price, Dial & Knob F800H complete ..... \$75  
 No. 19 instrument switch to match above ..... 1.00

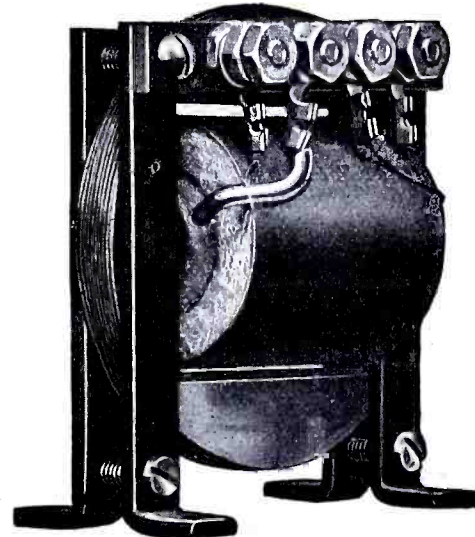

### The Amplifying Coil

Our amplifying coils are distinctly different in design and their remarkable power of amplification with the tubes at present on the market can be testified to by several thousand satisfied users. You need not experiment with untried products unless you want to.

Type Q. O. Amplifying coil as illustrated ..... \$4.00

Complete Catalogs Sent for 6c Stamps

Patronize your local dealer: If he won't supply our material your order will receive immediate factory attention.

## CLAPP-EASTHAM COMPANY

120 Main Street

Cambridge, Massachusetts

HEADQUARTERS FOR RADIOTRON TUBES. ALL TYPES IN STOCK



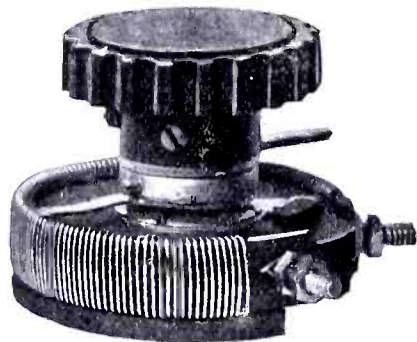

# WHAT IS CONDENSITE



A product of modern creative chemistry that possesses all of the properties essential to wireless insulation.

Condensite is made of carbolic acid and formaldehyde by scientific methods. It is not merely a compound, it is the result of years of research.

Remember these facts:—

Condensite is an exceptionally good electrical insulator.

Condensite is strong mechanically and very hard.

Condensite retains its finish indefinitely.

Condensite can be easily machined.

The next time you buy radio equipment insist that it be made of Condensite. Your dealer can get it, if you request it.

Condensite-Celoron made by the Diamond State Fibre Co., of Bridgeport, Penna., is the best material known for making panels.

—Specify

CONDENSITE CO. OF AMERICA, Bloomfield, New Jersey

## “CHI-RAD” VARIOMETERS AND COUPLERS

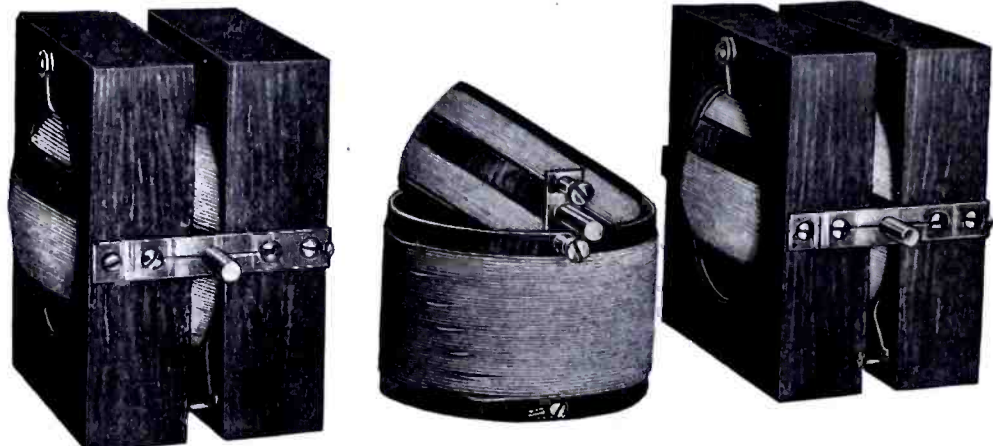

Variometer, P-1 \$5.00 (8 lbs.) Coupler, C-1 \$4.00 (2 lbs.) Variometer, G-1 \$5.00 (8 lbs.)  
Prices, completely assembled as shown. Include PP on weight given. Chelsea Dials, \$1.00 each.

### SPECIAL KNOCKED DOWN PARTS

The knocked down set includes all parts to make up two variometers and one coupler exactly as shown above. All windings in place, nothing to do but screw on bearings and connect up. Set can be completely assembled in 30 minutes. Price complete only \$10.00. Add PP on 6 lbs. Immediate delivery—the biggest value on the market—order your set today!

Read these specifications:  
Variometer forms 4 1/2" sq., 3" wide when assembled. Coupler primary Bakelite, 3 1/2" Diam., 3 1/2" high. All shafts 1/4" diam. Designed specially for panel mounting—all screws covered by dials when assembled. Range 175-450 meters. Special condenser to shunt across secondary and increase range to 650 meters 35c extra.

**CHICAGO RADIO APPARATUS CO., Inc.**

508 SO. DEARBORN ST.

(Phone Harrison 1716)

CHICAGO, ILL.

## A REAL BARGAIN

Send your order in today. Cuts approximately full size.



No. 60 binding post, polished nickel with knurled hard rubber top

was 12c now **08c.**

Send 2c stamp for descriptive catalogue R-21.

**DAVID KILLOCH COMPANY, 57 Murray St., NEW YORK**



No. 110 switch lever, polished nickel with finely knurled knob. Bushing also furnished with this lever

was 60c now **45c.**

use for the sparking surfaces of quenched gaps. Although it might appear expensive, the actual amount of silver used is very small and what little money is spent on these contacts will be very quickly returned in the satisfaction and service given by them.

The manner in which these contacts are attached to the sounder is very easily seen from Fig. 2. The lower contact shown in Fig. 3 is set into the left upright U of the sounder. This upright has a hole drilled and tapped at the point E, Fig. 2. The lower contact is threaded along the length of the shank and the contact screwed into the upright. This is the stationary contact. The dimensions of the hole and gauge of thread are not very important, but should be conveniently suited to the thickness of the upright. A convenient size would be that of the screw H in Fig. 2. The upper contact is set in the aluminum lever, as shown in Fig. 2. The lever is either milled out or cut out as shown, and the screw H extends a short distance below the cut out portion of the lever. The upper contact as shown in Fig. 4 has a hole drilled out and tapped in the shank, this hole and tap being of the size to fit on the screw H. The contact is then screwed onto the portion of screw H extending below the aluminum lever. The lever will not be particularly unbalanced, as the weight of the contact will balance the weight of aluminum cut out. In any event, this can be taken care of by means of the spring S. This is practically all the construction which has to be done.

The size of the actual key contact will depend on the power of the set. A contact surface 3/8" in diameter will take care of any currents up to that given by a 1-K.W. set and for lower powers the size can be correspondingly reduced. To take care of any overload it might be advisable to increase the diameter somewhat, say by 1/8", giving a total diameter of 1/2". This surface will undoubtedly handle any current up to those delivered by 2-K.W. sets.

The sounder, as made, will prove satisfactory in every detail. It might be that quicker action would be desired on the break, and this can be easily taken care of by the Spring S. By means of the screw K the tension of this spring can be varied until the proper action is obtained. The distance between the contacts can also be altered to suit the operator by means of the screw H, which will lower and raise the upper contact as desired. It will be advisable to connect between the screw H and K, as indicated, a flexible lead of heavy copper wire, to carry the current, in this way avoiding the passage of the current through the aluminum bar to the upright U<sub>2</sub> via the pivots P. This will prevent heating of the pivots.

The usual sounders in general come with the sub-base B, made of brass, the main base MB being of wood. This sub-base should be removed and the sounder attached to wooden base MB, the contacts are connected to the two uprights, and since these uprights are screwed to the sub-base B, the contacts would be shorted unless the sub-base were removed. The key contacts are brought out from the two screws G<sub>1</sub> and G<sub>2</sub> to two binding posts on the left. The binding posts on the right are, of course, the magnet binding posts connected to the main hand key circuit.

This method of altering the sounder and converting it into a relay key will be found simple, inexpensive, practical and operative. The method has been tried in other ways and found extremely satisfactory. In a similar manner any Morse relay may be converted into a relay key.

A welcome addition to your library! Send \$2.50 today, plus postage for 7 lbs., and your copy of bound volume No. 2 of Radio News will come forward by return mail.  
Experimenter Publishing Company, Inc. 236a Fulton Street, New York City



# RADIOPHONE "INTERPANEL" SYSTEM

REG. U.S. PAT. OFF.

## IS THE LAST WORD IN WIRELESS

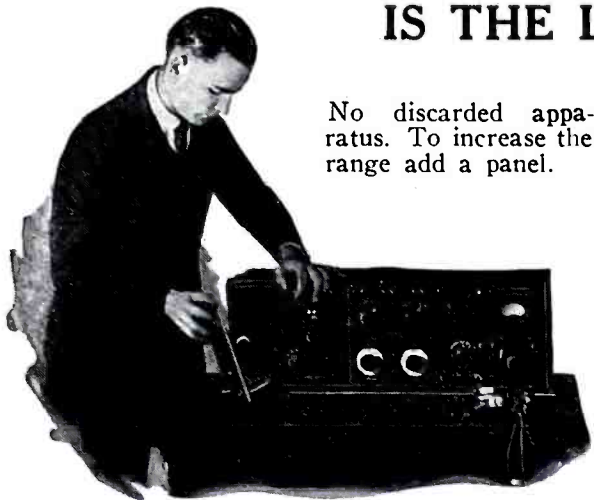

No discarded apparatus. To increase the range add a panel.

### FOUR PANEL STATION

Complete set of four units mounted in cabinets.

- (1) Complete radio "Midget" transmitter. Phone sending range 30 miles (OT-3).
- (2) Complete short wave tuner, 150 to 600 meters (MT-100).
- (3) Complete audion control, especially for gaseous tubes (MP-100).
- (4) Complete one-step amplifier (MP-200).
- (5) Any additional step of amplification may be added.

No system of wireless even approaches it in efficiency and low cost. It was invented by Dr. DeForest, and is built under the keen, watchful eye of the inventor.

The "Interpanel" is a long step forward in radio systems. It is the application of the unit idea of sectional bookcases. Unlike other systems it embodies the transmitter as well as the receiver. All you have to do in order to lengthen your range is to add a unit or "panel" without discarding a single piece of apparatus.

The DeForest "Interpanel" Radiophone is for CW transmission of both telephone and telegraph—the only up-to-date method of radio transmission.

There can be only one best—and the best is always the cheapest, particularly in radio apparatus. There is only one "Interpanel".

Write for catalog Address Dept. 107.

**DeForest Radio Tel. & Tel. Co., 1415 Sedgwick Ave., New York City**

*Manufacturers of Highest Grade Radio Apparatus*

Pacific Coast Distributors, HENRY M. SHAW, PACIFIC RADIO SUPPLIES CO., 638 Mission St., San Francisco, Cal.

***If it's a Radiophone—It's a DEFOREST Invention***



# Moulded Variometer \$6.50

## For Table or Panel Mounting

**"WONDERFUL" Was Verdict at Chicago Convention**

Further evidence of Marshall-Gerken progressive methods and keen understanding of the requirements of the most exacting users is readily apparent in these Variometers. The opinion was repeated over and over again during the Chicago Radio Convention, that it was not thought possible to produce a variometer of this quality at such a remarkably low price.

Our Mageco Variometer Types M. V. G. and M. V. P. are moulded composition, highly polished, which makes each part accurate to the thousandth of an inch. The windings are moulded right into the forms, are wound with green silk wire No. 22 for Grid and No. 20 for Plate and are not shellacked, thereby reducing the distributive capacity to a minimum.

The clearance of 1/16 of an inch between the rotor and stator gives a distributive capacity lower than any other type.

Another feature of this variometer is the simplicity with which it can be mounted on a panel, and four screws on front of stators provide the necessary means for mounting. Size 4 1/2" x 4 1/2" x 2 3/4" wide.



If your dealer does not carry them, write us, giving his name.  
Dealers: Order at once—the demand is big.

**THE MARSHALL-GERKEN CO.**

*Manufacturers and Jobbers*

30 Radio Building

Toledo, Ohio, U. S. A.



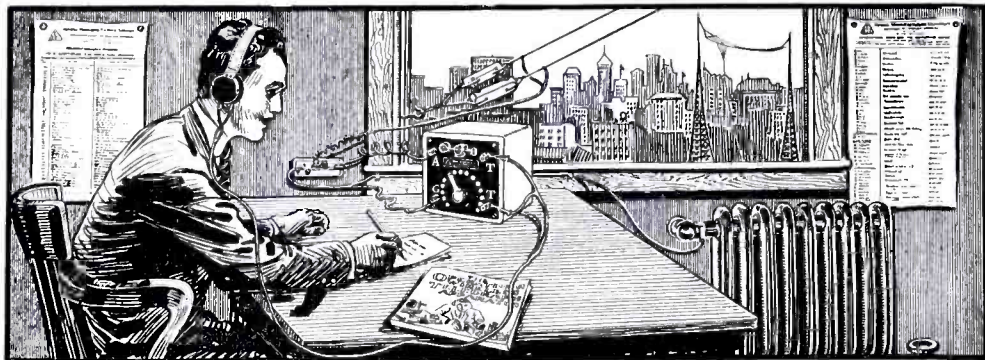

### COMPLETE RADIO RECEIVING OUTFIT

No additional parts required; complete in every detail. No batteries or other expensive renewal parts needed.

No license, or special knowledge necessary for operation; radio receiving outfit can be quickly set up for use.

Wave length range 180 to 2,500 meters.

It is not necessary to have a high, complicated antenna structure to receive radio signals with this set. Just connect a single aerial wire to the receiving set, ground one terminal, and connect phone to the other terminals and you are all set to receive all kinds of radio signals: messages from amateur stations, ships, wireless telephone speech and music, time signals, weather reports, press, etc.

LOOK FOR THE REGISTERED TRADE MARK ON EVERY GENUINE "MARVEL" RADIO RECEIVER; OTHERS ARE IMITATIONS.



TRADE MARK REG.

**DEALERS:** We are looking for several well established dealers to sell these sets in the various sections of the country. "MARVEL" Radio Sets are now widely advertised, and should prove to be a "best seller" in the fall and around the Holidays. Write for proposition.

**RADIO MFG. CO.**

Executive Offices, 170 Fifth Avenue

New York, N. Y.

COMPLETE "MARVEL" RADIO RECEIVING OUTFIT, Model 105 (as illustrated), consisting of a Model 101 "MARVEL" Radio Receiver, 150 ft. antenna wire, telephone with leather covered headband and telephone cord, 5 porcelain insulators, ground switch, ground clamp, code chart, abbreviation chart and instruction book, all put up in attractive box ..... **\$15.00**

"MARVEL" Radio Receiver, model 101, with code chart, abbreviation chart and instructions ..... **\$8.00**

Write for bulletin N-101.

Buy from your dealer; or sets will be shipped C.O.D. or on receipt of Postal or Express Money Order. Include parcels post charges. Shipping

Weight Model 105, 10 lbs.; weight Model 101, 4 lbs.



Pat. apd. for

No. 100—22½ Volts  
Size 7 x 4¼ x 2⅝



**Wireless B Battery**  
**Refillable Variable**

PRICE \$3.00

Refillable and variable B Battery especially designed for Vacuum tube work on plate circuits is guaranteed to be perfectly noiseless, it will give double the life of the ordinary battery.

The above cut shows part of the cover cut away which illustrates the convenience in inserting a new cell should one prove defective. These replacements are furnished complete with a positive and negative terminal soldered fast, and will be sent to any address upon receipt of 25c. They can be inserted without the use of soldering iron if desired.

Sample mailed to any address upon receipt of \$3.00.

**LIVE JOBBERS AND DEALERS WANTED**

**HIPWELL MANUFACTURING CO.,** 825-835 North Ave., N. S. PITTSBURGH, PA.

The Paris Radio Electric Co., is placing on the market the PARIS ROTARY GAP DISC, and in order to introduce this gap to the amateur fraternity, will give ABSOLUTELY FREE, to the amateur who works the greatest distance using the PARIS DISC, ONE HUNDRED DOLLARS (\$100.00) worth of radio apparatus of his own selection. This offer expires December 31, 1921. Price, \$6.00 Prepaid.

Better order your disc now, as orders will be filled in the order in which they are received. Write for full particulars.

We carry an extensive stock of standard radio equipment.

**Paris Radio Electric Co.**

42 S. Main St.

Paris, Texas

Insure your copy reaching you each month. Subscribe to *Radio News* —\$2.00 a year. Experimenter Pub. Co., 236 A Fulton Street, N. Y.

### C.W. for the Amateur

(Continued from page 301)

of a small step-up transformer and rectified by means of a chemical rectifier. The transformer core was obtained from an old top step-down transformer and is one square inch in cross section. Each leg is 4" long. The primary consists of 660 turns of No. 24 D.C.C. and the secondary of 3,000 turns of No. 28 S.C.C. The plate voltage is controlled by a rheostat in the primary.

For this purpose I am using Dimalite and it works quite satisfactorily, giving three distinct voltages from 500 down. Eight ordinary drinking glasses were used for the rectifier and the electrodes are one-half inch wide and immersed in the electrolyte for two inches. The solution consists of some "20 Mule Team" borax dissolved in a pail of distilled water. After the excess borax has settled, all the tumblers should be filled with the clear liquid to the same level. This is to keep the density of the solution the same in all the jars. Only distilled water should be added to take care of evaporation. The hook-up for the complete plate supply apparatus is shown in Fig. 2. By omitting the rectifier, the set may be operated with A.C. on the plate for I.C.W. The filament is heated by a separate transformer of the toy step-down variety, which permits the filament to be lighted before the plate current is turned on, thus prolonging the life of the tube. If the set is to be used for voice transmission, it is necessary to have

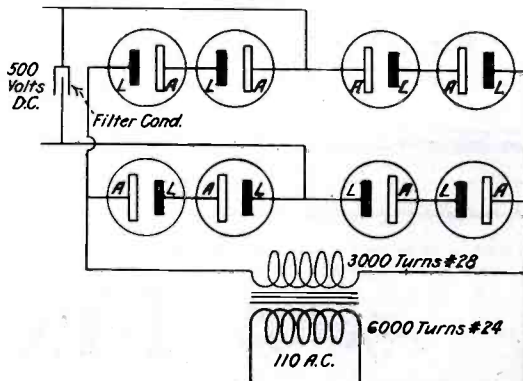

FIG. 2

Hook-up of the Transformer Rectifier Unit Supplying the H.T. D.C. to the Radiophone Set.

the center tap on the secondary of the filament heating transformer, but for C.W., I.C.W. and buzzer it may be omitted.

Although the set has been completed several weeks now, I have had very little time in which to find out what distances it is capable of covering. With an antenna of 16 ohms resistance and .0003 mfd. capacity the radiation is .4 of an ampere with a plate current of 25 milliamperes. With 55 milliamperes an antenna current of .8 was obtained, but owing to the excessive space current, the life of the tube was very short.

### A Universal Vacuum Tube Unit

(Continued from page 301)

parts at hand. It is suggested that the general plan of wiring and assembling as shown here be followed out, as this method gives a rigid mounting that will stand up under severe laboratory usage. It is believed that the photographs will convey all the information necessary without further explanation. However, I will be pleased to give any other information desired regarding this unit.

**QUITE SO.**

Biologist: "How many antennae have most bugs?"

Student (?): "Two, sir. One for sending, and one for receiving."

—Raymond E. Gower.



# use A-P tubes for efficiency

## NOTE NEW PRICES

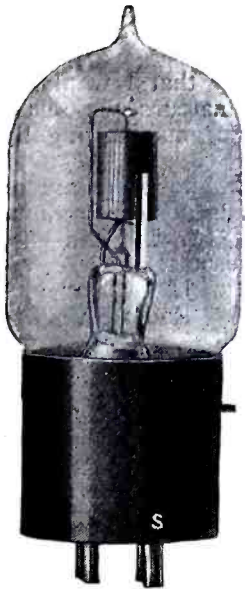

**THE A-P VT  
AMPLIFIER-  
OSCILLATOR**  
—the amplifier used  
by the U. S. Navy.  
“Use the tube the  
Navy uses.”  
**Price \$6.50**

*A-P Tubes are licensed by  
the Radio Corporation of  
America under the DeForest  
Audion and Fleming patents  
for amateur and experimental  
use in radio communication.*

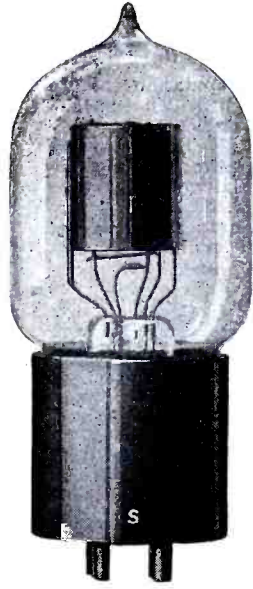

**THE A-P  
ELECTRON  
RELAY**  
—the most sensitive  
detector of spark sig-  
nals known to the  
radio art.  
**Price \$5.00**

*For the best book on Radio,  
ask your dealer for “Ele-  
ments of Radiotelegraphy,”  
by Lieut. Ellery W. Stone,  
U. S. N.*

Order from your dealer or write direct to

The Atlantic Radio Supplies Co., 8 Kirk Place, Newark, New Jersey  
The Pacific Radio Supplies Co., 638 Mission St., San Francisco, California

Distributors for

Moorhead Laboratories, Inc.  
Shaw Insulator Company

DeForest Radio Tel. & Tel. Co.  
Diamond State Fibre Company

## Do You Know WHY

the new Westinghouse Receiving Equip-  
ment was designed solely for use with  
**A-P Tubes?**

After the most exhausting tests in their laboratories  
at East Pittsburgh, the Westinghouse Research De-  
partment found that the A-P Tubes were the most  
efficient tubes on the market today—for regeneration  
—for amplification—for detection.

A-P Tubes proved to be the most quiet in operation  
and gave the loudest received signal strength. A-P  
Tubes also proved the most economical in filament con-  
sumption, requiring only half the A battery consumed  
by competitive tubes.

A-P Tubes are the pioneer tubes on the market to-  
day. They have passed the experimental stage and  
are a proved success. They have the highest base  
insulation of any tube on the market, and are the  
result of the design of the British, French and Ameri-  
can Governments under the rigorous specifications of  
military requirements. It is not surprising that A-P  
Tubes are approved and adopted by the Westinghouse  
Electric & Mfg. Co.



# PARAGON



MEANS  
“PERFECT MODEL OF EXCELLENCE”  
AND IT IS IMMEDIATE SHIPMENT

We have stocked up enormously for what we confidently  
to be Radio's biggest season and are in a position to ship all orders  
the same day on which they are received. Order your needs at once from  
the house whose motto is, “Service and Quality.”

- Rhamstine Amplifying Transformer, ship. weight 1 lb.....\$3.50
- Complete plug and jack, shipping weight 1 lb..... 1.50
- Plug as illustrated, ship.  
weight, 4 oz.....\$ .75
- Jacks, two circuit ship.  
weight 4 oz..... .85
- Radiotron, U.V. 200,  
ship. weight 1 lb.... 5.00
- Radiotron, U.V. 201,  
ship. weight 1 lb.... 6.50
- Radiotron, U.V. 202,  
ship. weight 1 lb.... 8.00

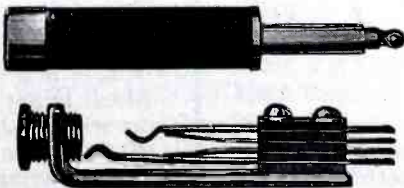

- Radiotron, U.V. 203, ship. weight 3 lb.....30.00
- Radio Corporation, U.V. 712, inter-valve transformer, ship. weight  
2 lb. .... 7.00
- Radio Corporation A Battery potentiometer, ship. weight 1 lb.. 2.00
- Mesco transmitting key, ship. weight 1 lb..... 1.90
- Mesco 1 K.W. transmitting key, ship. weight 1 lb..... 4.00
- Murdock socket, ship. weight 1 lb..... 1.00
- Murdock rheostat, ship. weight 1 lb..... 1.00
- Chelsea 43 plate panel mtg. condenser with dial, shipping weight,  
3 lbs. .... 4.75
- Chelsea 28 plate panel mtg. condenser with dial, shipping weight  
2 lbs. .... 4.25

Send 15c for our big illustrated catalogue

**ELECTRICAL SPECIALTY COMPANY**  
48-50 SOUTH FRONT STREET  
COLUMBUS, OHIO



**★ FREE ★ One Chelsea Bakelite Dial and Knob**  
**With the purchase of each EMPIRE Variometer or Variocoupler**

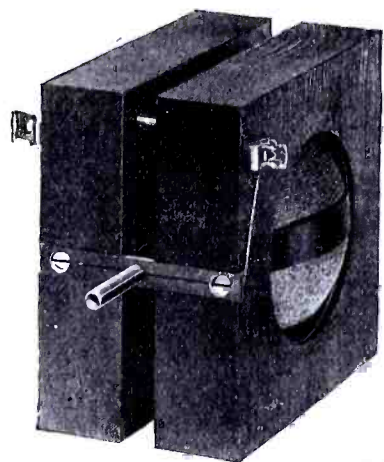

Price \$7.00



Price \$6.50

**DESCRIPTION**

These instruments are made from the best materials available. The wooden parts are turned from thoroughly seasoned hard wood. The primary of the variocoupler is of bakelite tubing. The windings are specially treated to prevent loosening. Fahstock clips are provided for connections.

Send 10c for catalogue, money credited to first dollar purchase

**Empire Radio Equipment Co.**

Manufacturers and Distributors of Radio Apparatus

271 West 125th Street

New York City

**KANSAS CITY RADIO SUPPLY**

Formerly McGreary Radio Supply Company

Authorized Central Distributors and Jobbers of Radio Corporation Products, Westinghouse Regenerative Sets, Magnavox and Radio Magnavox Apparatus, and Burgess Batteries. Reputable Dealers—We Can Supply You at Standard Discounts.

**Quick Service on Radio Supplies**

Write for Price Lists. We can fill all your Radio Needs Direct from Kansas City. Prices Right. Listen for our Radio Phone Bulletins and Concerts nightly from 8 to 11 o'clock.

**SPECIAL BARGAINS IN VARIOMETERS AND VARIOCOUPERS**

Same quality we manufacture for one of largest dealers in the country. Small size makes them extremely efficient on amateur waves. Fine for radio telephone work. Will tune below 200 meters. Make your own regenerative set complete for less than \$20. Why pay more? Order early for we anticipate a great demand at this special price.

**Western Radio Company**

Fourth and Delaware

KANSAS CITY, MISSOURI

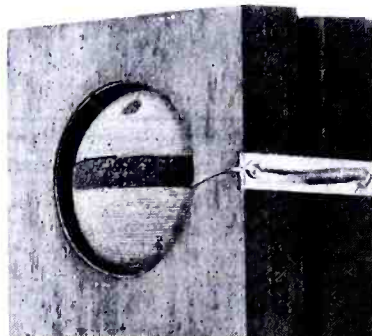

**Introductory Offer**

K. C. Variometers **\$4.95**

K. C. Variocoupler **\$5.95**

Postage Prepaid

Radio Station, 9XAB

3000 Ohms



**\$8 POST-PAID**

**"RED HEADS"**

The Accepted Standard in Radio Receivers.

At the new price of \$8.00 (formerly \$12.50) "Red Heads" are unquestionably the best wireless 'phone value in the world. Increased production, decreased costs and a sincere desire to promote lower prices prompt this remarkable saving.

**SPECIFICATIONS:** Aluminum back type with genuine bakelite ear caps, government type head band, extra fine 6 ft. cord with strain loops. Each receiver 1500 ohms (3000 ohms per pair). Sold on a money back guarantee basis and shipped prepaid anywhere on receipt of price. Dealers: Write for complete information.

**THE NEWMAN-STERN CO.**

Newman-Stern Bldg., Cleveland, Ohio

**STORAGE BATTERIES FOR WIRELESS USE**

**Special Prices**

Volts	Amps.	Price
6	20	\$7.50
6	40	10.00
6	60	13.75
6	80-100	22.50

One year unconditional guarantee, free repair or a new battery at our option, shipped fully charged, ready for use.

Add \$.50 for special crating.

Distributors—Jobbers—Dealers—write for discounts and exclusive territories. If your dealer hasn't it, send check or money order direct.

**P. M. DREYFUSS CO., Inc.**

150 Chambers St.

New York City

result of the armature being off center in the field, and this heating in turn causes excessive wearing away of the carbon brushes, which brings on sparking and more heating. So it will be seen that the proper alignment of the bearings is very important, and if you have reason to suspect that your motor is performing badly for this reason, it is best to have a good reliable motor-man work on it. I do not mean by this the one who drives a street car, nor yet one of the million so-called electricians, whose ability is confined to bending pipe and stringing wire. I refer to a man whom you know has had plenty of experience in motor repair and upkeep work; the man who knows a motor and why it is built as it is. If your motor or generator persistently blows up, it is an indication that you are getting surges or kick-backs, or high induced voltages from other lines; there is a higher voltage on the windings than they are designed to stand, and your troubles will not be solved until you remove this high voltage. Protective resistances or capacities are used to guard against this, also armored or lead-covered wires with the armor grounded. Do not lose sight of the fact that if you take a handful of eight or ten D.C. power wires and one or two A.C. power wires, and tape them all into a cable, you are making a nice little transformer to feed voltage into your motor windings. If you use a rotary gap, either synchronous or non-synchronous, give careful attention to the arrangement of circuits; do not allow the high tension oscillating circuit to become familiar with the low tension power circuits. If your motor persists in sparking, do not waste your money buying commutator compounds guaranteed to prevent sparking, you will only gum up your brushes and brush-holders and make matters worse. These compounds are put up to give a gloss to commutators carrying large currents; where a little roughness counts they are not necessary for small motors.

If your motor does not run sparkless, there is a perfectly good reason for it, which any amount of grease will not remedy. Rough or worn commutator, high mica between bars, or a high commutator bar, hard brushes or brushes worn too short, too little spring tension or binding in the brush-holder, broken brushes or brushes placed improperly on the commutator, open coils, and brushes too wide or too narrow, are some of the causes for sparking. If your alternator shows its proper voltage at the brushes, but you do not get a spark upon closing the key, see if you have voltage across the transformer primary with the key closed; if not, the trouble lies in the leads or connections. If the voltage is there, disconnect and test out both primary and secondary for open circuits, using the test lamp. If the transformer is O.K., the trouble must be in the condenser, the spark gap, the oscillation transformer, or the high tension wiring or connections, and testing them out in that order will reveal the trouble. If the spark is there but no radiation is obtained, test the meter to find out if it is burned out; next look for a ground on the antenna or an open ground lead, then the oscillation transformer and its connections. The trouble might also be due to a short circuit, which might cut out all or part of the condenser, or the oscillation transformer, thus throwing the circuits badly out of resonance or destroying the coupling.

If your automatic starter will not function and the connections and wiring are good, the presence of the proper voltage across the starter coil indicates that either the coil is open or adjustments are required. If your storage battery will not come up to voltage, read the voltage across each cell while they are charging. A short circuited cell will show no drop, a badly sulphated cell will show a high drop. If the entire battery is sulphated the plates will have a



Condenser No. 3

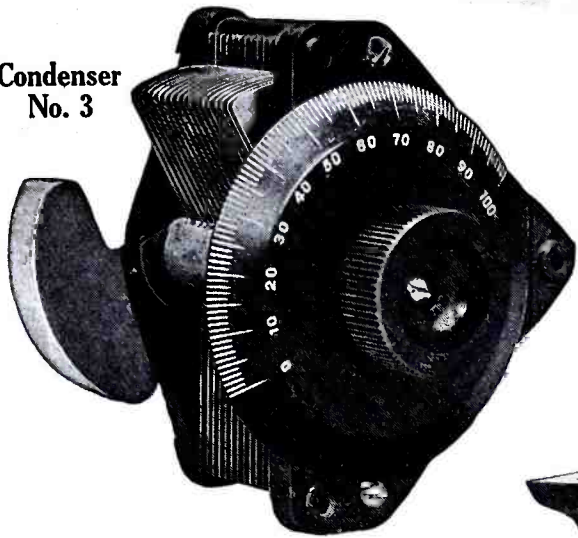

# CHELSEA

Variable Condensers  
(Die-Cast Type)

- No. 1.—.0011 m. f. mounted.....\$5.00
- No. 2.—.0006 m. f. mounted..... 4.50
- No. 3.—.0011 m. f. unmounted..... 4.75
- No. 3.—.0011 m. f. unmounted, without dial 4.35
- No. 4.—.0006 m. f. unmounted..... 4.25
- No. 4.—.0006 m. f. unmounted, without dial 3.85

Top, bottom and knob are genuine bakelite, shaft of steel running in bronze bearings, adjustable tension on movable plates, large bakelite dial reading in hundredths, high capacity, amply separated and accurately spaced plates.

Unmounted types will fit any panel and are equipped with counterweight.

Purchase from your dealer; if he does not carry it, send to us.

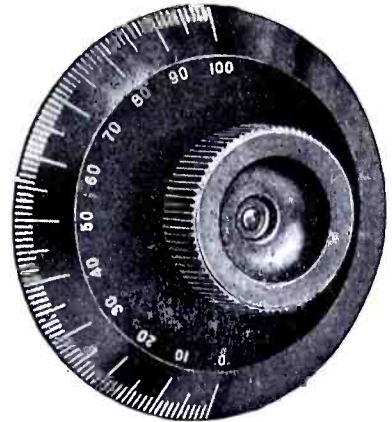

"CHELSEA" BAKELITE DIAL NO. 41.

The Chelsea dials are made of genuine bakelite, beautifully finished, and bear a 100 division semi-circular scale.

The dial is 3 3/4 inches in diameter, 1/4 inch thick, with a long, sloping, easily read marking. Chelsea bakelite dials run true and will not warp.

The complete dial and knob is made to fit either 3/16, 1/4 or 5/16 inch shaft. Specify size when ordering, otherwise the 1/4 inch hole will be furnished.

Chelsea dials are beautiful in appearance low in price accurate and durable in service, unexcelled by any, at any price.

Dial and knob complete.....\$1.00

Purchase from your dealer.



NO. 50 PRICE AS SHOWN, \$4.50

The Chelsea Amplifying Transformer is a supreme attainment in the design of Audio Frequency Transformers. It embodies the highest grade of materials obtainable and proper design, which reflects the result attained namely high amplification factor. It is unequalled either in electrical characteristics or good appearance.

## CHELSEA RADIO CO., 150 Fifth Street, Chelsea, Mass.

Manufacturers of Radio Apparatus and Moulders of Bakelite

### G. M. PROUDFOOT

## DETECTOR AND TWO-STEP AMPLIFIER

\$35.00

\$35.00

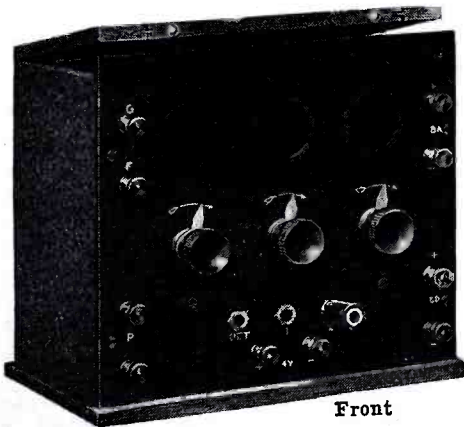

Front

Highest  
Quality  
Lowest  
Prices



Rear

DETECTOR AND ONE-STAGE AMPLIFIER \$25.00, IS DUPLICATE OF ABOVE CUT, ONLY ONE UNIT LESS.

The Operating Characteristics of All Our Instruments are Equal to Any on the Market Regardless of Price

\$35.00

\$35.00

\$35.00

THE DESIGN AND CONSTRUCTION ARE SUCH THAT MAXIMUM AMPLIFICATION IS OBTAINED AND NO HOWLING PANEL 3/16", HAND RUBBED AND ENGRAVED WITH WHITE LETTERS. BAKELITE IS 7 1/2" x 8 3/4". CABINET 5" DEEP. INSTRUMENTS LOOK BETTER THAN PHOTOGRAPHS. PLUG FOR FONES FURNISHED WITH INSTRUMENTS. FILAMENT CONTROL BY PLUG \$10.00 ADDITIONAL.

CABINETS  
QUARTER  
SAWED OAK  
WAXED FINISH  
MAHOGANY  
FINISH IF  
DESIRED  
\$35.00

—NOTE THESE PRICES—

- Detector Cabinet, fixed condenser grid leak, complete....\$10.00
- One Stage Amplifier ..... 18.00
- Two Stage Amplifier ..... 25.00
- Detector and One Stage Amplifier ..... 25.00
- Detector and Two Stage Amplifier ..... 35.00
- Detector and Three Stage Amplifier..... 55.00
- Long and Short Wave Receiving Set, 150-25,000 Meters... 195.00

ALL INSTRUMENTS TESTED IN LABORATORY AND UNDER WORKING CONDITIONS.  
\$35.00

EVERYTHING GUARANTEED

G. M. PROUDFOOT, 361 E. Ohio Street, Chicago, Illinois



# “Service and Saving”

The Mutual Purchasers is a co-operative association rendering a fast accurate service to experimenters in all parts of the country. It enables them to purchase practically everything radio at considerable saving.

You can join the association without cost. Send stamp for detailed information or order anything radio you need and note the saving.

**SPECIAL OFFER:**

Baldwin Phones at greatly reduced prices.  
 Type C Navy Style .....\$13.55  
 Type E Small Style ..... 15.00  
 Type F Improved Small Style 16.25  
 8% credit returned to members on these reduced prices.

**STORAGE BATTERIES:**

Marko 6 volt 20-40 ampere hour.....\$14.60  
 Marko 6 volt 40-60 ampere hour..... 17.10  
 Marko 6 volt 60-80 ampere hour..... 21.60  
 Marko 8 volt 20-40 ampere hour..... 18.70  
 Marko 8 volt 40-60 ampere hour..... 25.40  
 Above batteries designed especially for tube lighting. 8% credit returned to members.

**MUTUAL PURCHASERS ASSOCIATION**

**2 STONE STREET Dept. N-1 NEW YORK CITY**

## IT'S JUST THE TUNER FOR RADIO PHONE CONCERTS \$20.

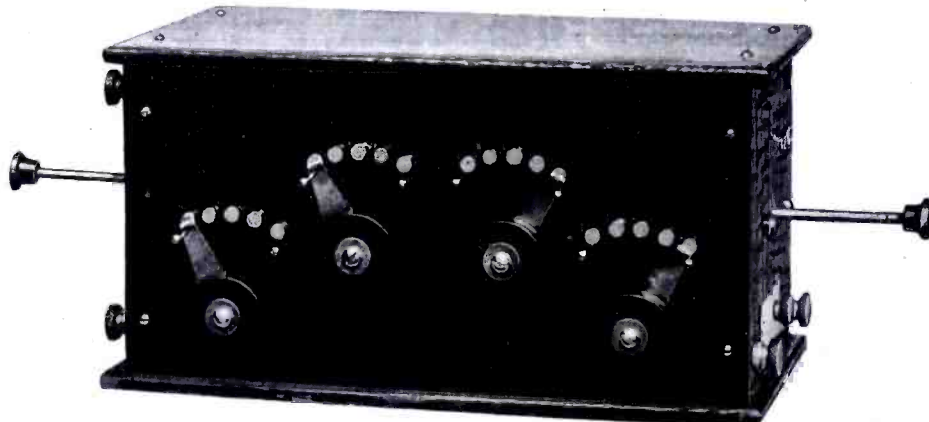

Our Short Wave Regenerative Tuner has been improved with new switches and knobs. It has two primary switches with five taps each, 5 taps on secondary and 5 taps on tickler coil. There are two smaller inductances enclosed and movable within the main windings which insure very close tuning and signals as clear as a whistle. It is worth every cent we ask and more. It has a quartered oak cabinet and hard rubber panel. Price only \$20.00.

Mr. R. B. Moulden, Tuscola, Ill., says: "I cannot say enough for the Colby Tuner. It works both spark and arc fine, and as for music it is great. I hear KDKA every night, also hear NSF, 9LY and many others. This tuner is much easier to locate and tune in than any tuner I ever tried. I do not believe anyone will make a mistake in getting one."

SEND A 2-CENT STAMP FOR BULLETINS.

**Colby's Telegraph School Auburn, N. Y.**

**FREE With Each U. V. 202 Power Tube FREE**

With each Radiotron U.V.202 power tube, for radiophone and C. W. transmission, we will supply free of charge your choice of either the latest Murdock Improved contact type V.T. socket for use with the above tube or a 4 ampere Clapp-Eastham panel mounting rheostat, or the Radio Corporation of America's special 5000 ohm, size "M" Grid Leak with midtap at 3,500 ohms, designed by the General Electric Company for use with the U.V. 202. Price \$3.00.

Our engineering department, upon learning the number and size of the power tubes you are contemplating to operate, will be pleased to recommend the correct capacity and voltage of the motor generator as well as the correct scale readings of the meters. We have excellent motor generators of various capacities and voltages, at reasonable prices, as well as jewel bearing meters, radio frequency, D.C. or A.C. Only new and high grades apparatus carried in stock and all goods guaranteed to arrive in perfect condition.

All orders are filled within twelve hours and are shipped postpaid and insured.

**THE KEHLER RADIO LABORATORIES, ABILENE, KANSAS**

**QUALITY and SERVICE**

Let us show you how to get both! We only do mailorder business. Orders filled within six hours and shipped postpaid to first 5 zones.

DeForest — Firth — General Radio — Radio Corporation — Pacont — Murdock — Aome — Chelsea Radio — Radio Service — Remier Fada and Soraino

Send Post Office money order with your order and get SUPER-SERVICE.

**NEW ENGLAND RADIO COMPANY**  
 Box 95 BOSTON, 17, MASS.

VARIOMETERS, inside windings, \$3.75; Varico-couplers, BAKELITE TUBES, \$3.75; WOODEN BALLS, 55 cents each; 20/58 LITZ, 2 cents per foot; OAK CABINETS, 7 x 18 x 8" deep, \$3.50; other sizes in proportion; 22 DCC MAGNET WIRE, 30 cents quarter pound, all sizes carried. Hard maple stators for variometers.....\$ 1.20 Windings in place ..... 1.20 Bakelite Tubes wound for primary varico-coupler ..... 1.20 Variometer and varico-coupler balls with axes and wound ..... 1.20 Detector units with cabinets ..... 5.00 Panels only, drilled and engraved ..... 3.00 Regenerative sets in oak cabinets complete with detector units, unwired..... 25.00

Dealers Write for Proposition.

MEADE BAKELITE & RADIO APPARATUS, 522 Central Ave. B'hlyn, N.Y.

white color and the specific gravity of the solution will remain low. The remedy for sulphation is long charging at heavy rates; the sulphate on the plates must be dissolved and absorbed by the solution before normal conditions may be regained. In charging at a higher rate than normal, however, care must be taken that the temperature does not rise too high, or buckling of the plates may result. Short circuited cells are usually the result of broken separators or buckled plates, and should be taken out of circuit and treated separately.

It sometimes happens that individual cells will reverse polarity under heavy discharge, and individual treatment is required in this case also. If, when you attempt to place the battery on charge, things about the room start skyward, the line polarity is probably reversed. This is very often caused by the battery discharging back through the charging machine, which was stopped without the switches first being pulled. Every battery should be equipped with an overload and a no-load release to prevent this. The storage battery is a faithful servant if treated properly, but becomes a devil after a period of misuse, or bad treatment. One cause of the neglect which storage batteries have to endure is the well-known manner in which they destroy clothes, but there is a bill before Congress to compel owners to furnish operators with diving suits in which to work on their batteries, so cheer up.

In case the specific gravity refuses to come up after treatment, inspect the hydrometer carefully for cracks. If the receiver refuses to work, it is good practice to see first that the telephones are in working order; they may be tested across a dry cell or one of the storage cells. The primary side of the receiver may be tested for open circuit with a buzzer and a few dry cells. If it is found that this circuit is intact from antenna entrance to ground, then the balance of the circuits may be tested in the same way. If the coils are of high inductance, the buzzer may not work through the full length of the coils, and in this case the coils may be tested in sections. The condensers may also be tested for short circuiting with the buzzer.

**Radio Digest**

(Continued from page 296)

Supplementing this feature are separate alphabetical company listings of over 4,900 manufacturers, so that main and branch offices, executive officers and other information about them can be quickly ascertained. A further type of entries in the products class consists of about 4,500 trade names which enable one to find readily the name of the manufacturer using each.

The dictionary feature includes, besides the definitions of the products referred to, definitions of several thousand electrical words, terms and abbreviations, also of magnetic, photometric, chemical and other terms closely related to the electrical. These definitions cover words of theoretical or scientific nature as well as those of practical and trade interest. They are written in as simple a style as is consistent with technical accuracy.

Among the numerous topics constituting the encyclopedia feature of the book are historical and statistical articles, reviewing the development and present status of the electrical industry as a whole and each of its principal branches, also similar articles on all important electrical applications. These include not only the better known electrical developments, such as the electric public utilities, but those on which information is not so readily available, for example, X-rays, electric ship propulsion, steam railroad electrification, electric welding, wire and cable manufacture, radio communication, etc. There are also articles with current information about each of the



# SOMETHING NEW IN RADIO

## MAKE YOUR OWN

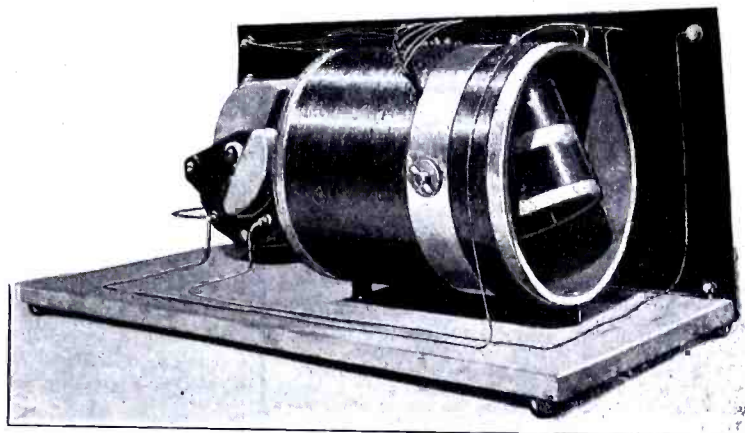
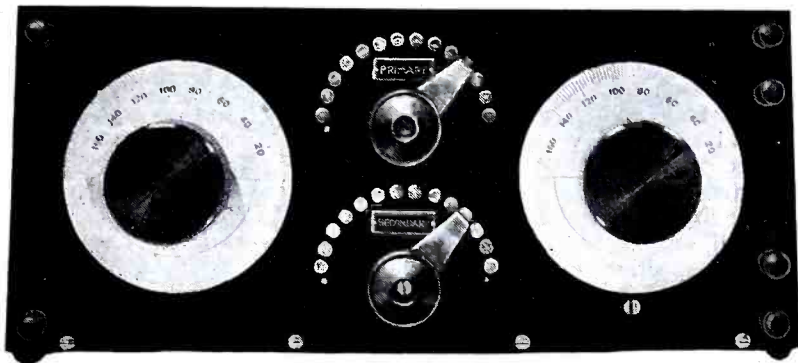

You can build this regenerative receiver easily without a machine shop. With the set of patterns especially designed it becomes a simple and easy work to make and assemble the parts comprising this set with which spark, C. W. signals and Radiotelephony may be received.

**W**E hereby offer the first of our series of "Make Your Own" apparatus set, the first one being a

### Complete short wave regenerative set.

One of the foremost Radio engineers has constructed this set for us, specially for the amateur, and by our modern, novel methods of construction, anyone is able to make an efficient apparatus for the reception of wave-lengths up to 800 meters.

The circuit used is of the single inductance type and is the same as that used in new and well-known expensive sets recently placed on the market. With this circuit, a good selectivity is obtained, owing to the fact that the resistance of the winding in this set is rather low and so does not practically affect the resistance of the aerial, which consequently operates as a wave collector with maximum efficiency.

Another benefit resulting from the use of this circuit is the simplicity in tuning, a factor not to be neglected by the amateur not having had a long experience with regenerative circuits, in the reception of damped, undamped and radio telephone signals.

In building a Radio apparatus the lack of mechanical knowledge often handicaps

the amateur in such a way that the instrument he builds has not the standard made appearance which is desirable in any Radio apparatus. In order to remedy this, and give the amateur a chance to turn out an efficient and handsome looking instrument, we have designed a special set of patterns enabling anyone to make a standard receiver with all the improvements that can be found in expensive ready-made apparatus.

With this set of patterns and by following the instructions given it is very easy with the use of only a few tools to turn out the short wave regenerative receiver shown in our two photographs.

The novel departure in this set of patterns is that we do not merely give you pictures of how the apparatus looks, and mere diagrams—**BUT EACH AND EVERY PATTERN SUPPLIED IS FULL SIZE.**

Take for instance the pattern for the panel. It is printed on heavy blue-print paper exactly the size of the panel to be

used. The position of the holes and other markings are exact, so that all you have to do is to paste the pattern on top of your bakelite panel by means of ordinary library paste, and when dry drill right through the pattern wherever the marks are located.

This does away with all fussing and calculating as we have done all the laying out in our own shop, and you need not worry that the final instrument does not come out right.

Similar methods are used for winding the tubes, where a complete pattern is furnished so you cannot go wrong. For instance, the pattern is wound upon the tube; then you can wind the wire right on top of this, if you wish. *We have done the thinking for you.*

**BEFORE SELLING YOU THIS PATTERN WE HAVE GONE TO THE TROUBLE OF ACTUALLY BUILDING THE OUTFIT AND WE KNOW THAT IT IS ABSOLUTELY RIGHT IN ALL PARTICULARS.**

The original may be inspected at any time. Only standard parts are used in making the outfit. It is possible to build the entire set as illustrated for about \$12 to \$15.

Complete and very explicit directions go with the pattern which is furnished in a heavy envelope 9 x 12".

Complete pattern for short wave regenerative set each prepaid  
**50c.**

Either Direct from us or for sale by the following responsible Dealers:

Am. Electro Tech. App. Co., N. Y. City	Hall Electric Co., Wm. Dayton, O.	Noll & Co., E. P., Philadelphia, Pa.	Sears, Roebuck & Co., Chicago, Ill.
Alamo Sales Corp., Indianapolis, Ind.	Hico Wireless Sup. Co., Marion, Ill.	Northwest Radio Serv. Co., Seattle, Wash.	Service Radio School, Washington, D. C.
American Hdw. Stores, Bridgeport, Conn.	Hickson Electric Co., Rochester, N. Y.	N. S. W. Bookstall Co., Sydney, Australia	Shotton Radio Mfg. Co., Scranton, Pa.
Atlantic Radio Co., Boston, Mass.	Holt Electric Util. Co., Jacksonville, Fla.	Patent Electric Co., New York City	Smith Bros., Sarnia, Ont., Canada
Bamberger & Co., L., Newark, N. J.	Hughes Elec'l. Corp., Syracuse, N. Y.	Parks, Henry Francis, Butte, Mont.	Smith Novotoy Elec. Inc., Charlotte, N. C.
Benwood Specialty Co., St. Louis, Mo.	Jenkins, Lester L., New Bedford, Mass.	Paramount Radio Sup. Co., Atlantic City	So. California Elec. Co., Los Angeles, Cal.
Brode Electric Co., Los Angeles, Cal.	Karlowa Radio Corp., Rock Island, Ill.	Pearlman's Book Shop, Washington, D. C.	Southern Elec'l. Sup. Co., San Diego, Cal.
Brown, J. Edw., Glenbrook, Conn.	Katzenbach & Co., F. S., Trenton, N. J.	Penn. Radio Apparatus Co., Reading, Pa.	Southwest Radio Sup. Co., Dallas, Tex.
Fullock's, York, Neb.	Kendall Co., W. D., Worcester, Mass.	Penn. Marconi Wireless Sch., Phila., Pa.	Sprott-Shaw Sch., Vancouver, B. C.
Bunnell & Co., J. H., New York City	Killoch Co., David, New York City	Piedmont Electric Co., Phila., Pa.	Sterling Electric Co., Minneapolis, Minn.
Burham & Co., Deptford, S. E. 8, England	Klaus Radio Co., Eureka, Ill.	Pioneer Electric Co., Asheville, N. C.	Stubbs Electric Co., Portland, Ore.
California Elec. Co., San Francisco, Cal.	Kluge, Arno A., Los Angeles, Cal.	Pitts. Radio Sup. Co., Boston, Mass.	T. & H. Radio Co., Anthony, Kans.
Catton, Neill & Co., Honolulu, T. H.	Krause & Co., A. F., Detroit, Mich.	Post Office News Co., Chicago, Ill.	United Elec. Stores Co., Braddock, Pa.
Central Radio Co., Independence, Mo.	Kusel Co., D. & F., Watertown, Wis.	Precision Equipment Co., Cincinnati, O.	Warner Bros., Oakland, Cal.
Central Radio Co., Kansas City, Mo.	Lehigh Radio Co., Bethlehem, Pa.	Radio Distributing Co., Newark, N. J.	West'n Radio Elec. Co., Los Angeles, Cal.
Chase, Geo. H., Newport, R. I.	Liberty Radio Sup. Co., Chicago, Ill.	Radio Electric Co., Pittsburgh, Pa.	Whitall Electric Co., Westerly, R. I.
Chicago Radio Ap. Co., Chicago, Ill.	Linze Elec'l. Sup. Co., St. Louis, Mo.	Radio Equipment Co., Boston, Mass.	White Co., The, Columbus, Ga.
Con. Radio & Elec. Corp., N. Y. City	Luther, H. E., Centerville, Ia.	Radio Equip't. & Mfg. Co., Minneapolis	White & Boyer Co., Washington, D. C.
Cutting & Washington, New York City	McCarthy Bros. & Ford, Buffalo, N. Y.	Radioelectric Shop, Cleveland, O.	Williamson Elec. Co., Seattle, Wash.
Delancey-Felch & Co., Pawtucket, R. I.	Manhattan Elec. Sup. Co., N. Y. & Chic.	Ray-DI-Co., Chicago, Ill.	Wilmington Elec. Spec. Co., Wilmington
Detroit Electric Co., Detroit, Mich.	Marshall-Gerken Co., Toledo, O.	Reuter Electric Co., Cincinnati, O.	Winner Radio Co., Aurora, Colo.
Dewey Spitz Goods Co., Milwaukee, Wis.	Meter Elec'l. Const. Co., Oshkosh, Wis.	R. I. Elec. Equip't. Co., Providence, R. I.	Wireless Mfg. Co., Canton, O.
Doubleday-Hill Elec. Co., Pittsburgh, Pa.	Meyberg Co., Leo J., San Francisco, Cal.	Riverside Laboratory, Milwaukee, Wis.	Wireless Press, New York City
Dunn, J. J., Pasadena, Cal.	Mohawk Elec'l. Sup. Co., Syracuse, N. Y.	Rose Radio Supply, New Orleans, La.	Wolfe Electric Co., Omaha, Neb.
Electric Motor & Eng. Co., Canton, O.	Nat'l Radio Institute, Washington, D. C.	Roy News Co., Fre'k J., Toronto, Can.	Y. M. C. A., Los Angeles, Cal.
Electro Importing Co., N. Y. City	New Era Shop, Milwaukee, Wis.	Sayre-Level Radio Co., Phila., Pa.	Zamoiski Co., Jas. M., Baltimore, Md.
Findley Electric Co., Minneapolis, Minn.	Newman-Stern Co., Cleveland, O.	Schmidt & Co., R., Rochester, N. Y.	Zibart Bros., Nashville, Tenn.
Fuller Co., Seth W., Boston, Mass.	Nichols Radio Sup. Co., Bwlg Green, Ky.		
Gurd & Co., Wm., London, Canada	Nola Radio Co., New Orleans, La.		

**Consolidated Radio Call Book Co., Inc., 98 Park Place, New York City**



# MEMORIZE CONTINENTAL CODE ALMOST INSTANTLY BKUMA YRLSBUG

**Beginners Have Reported Mastered Code in 30 Minutes. In 45 Minutes. In One Hour, One Evening, Etc., Etc.**

Anybody who can read can learn code quickly and easily.

Dear Sir.—To encourage beginners can say I memorized Continental Code by your Short Cut in 45 minutes and same was a great help. It is a wonderful little chart and as it has helped me so will it help others. Thanking you.

Later.—Now have a licensed station all right and would say again sincerely hope your Chart which made Continental Code so very plain and simple may be used by many and prove as helpful as in my case.

David E. Day, Winston-Salem, N. C.  
Call 4BM P. O. Box 48.

Worthless methods are advertised as best, easiest, quickest and other enticing titles. To avoid disappointment purchase no Code Memorizing Chart, Card or Device until satisfied by statement from actual user that same has proven efficient in use as well as in theory.

### INVESTIGATE

If interested, not just curious, send ten cents for 28-page Booklet of information and Reports, giving local addresses, from 200 Short Cut beginners scattered over 44 States. Coupon for one dime good whenever you purchase will be enclosed. These reports from our quickly successful students are the concrete and tangible expression of desire to aid and encourage present and future beginners to equally quick progress over that rocky place in the road to amateur success—perfect Mastery of Code. The amateur of today will be the top notch operator of tomorrow.

THOSE WHO fall by other methods succeed by Dodge Short Cut.  
MORSE OPERATORS change to radio easily and quickly—no mixup.  
REPORTS IN BOOKLET tell the story.

NO BEGINNER CAN AFFORD TO IGNORE quick and easy success of those who have used DODGE ONE DOLLAR RADIO SHORT CUT WHICH TEACHES WITHOUT INSTRUMENTS. SAVES FIFTY DOLLARS TIME AND HOLDS THE RECORD FOR SIMPLICITY, EFFICIENCY, ECONOMY AND QUICK RESULTS.

**C. K. DODGE**

Box 200 MAMARONECK, N. Y.

## QST! QST! QST!

**For the DX radio man  
THIS MONTH ONLY**

GUARANTEED 6 Volt 60 to 80 Ampere hour storage batteries. Limited number only. Price, each \$12.35  
Announcing a 20 Watt telephone transmitter. A superb, well constructed telephone panel. Can be used either for voice or buzzer modulation. Range 50 to 250 miles. Price \$130.00  
Also a combination long and short wave receiving set. Range 150 to 25,000 meters. Price \$125.00  
Rectifier panel. Converting A.C. into 500 D. C. Absolutely no hum. Price \$130.00  
Small 5 Watt telephone panel. Range 5 to 15 miles. Price \$50.00  
Two-stage amplifiers. Audibility amplification 400 times. Guaranteed no howling or squealing. Price \$45.00  
Detector and two-stage amplifier. Price \$65.00  
Short wave regenerator sets. Price \$45.00  
SPECIAL—Genuine audiotron with adapter. Price \$5.00

Write for descriptive circulars on the above apparatus. We build transmitting and receiving sets to your own specifications. Phone sets a specialty.

**BRONX RADIO EQUIPMENT CO.**

687 Courtlandt Ave. Bronx, N. Y. C.  
Radio Station—2 BXA.  
Concerts Monday and Friday nights.

## PLATINUM IRIDIO-PLATINUM WALLOSTON WIRE

for all radio work at prevailing market prices

**WILDBERG BROS.—PLATINUM REFINERS**  
Pacific Building, San Francisco

national electrical societies, electrical codes, patents, trade-marks, exports and many other electrical activities; list of electrical engineering colleges and other electrical schools with data about each; similar lists and data of electrical libraries, periodicals and testing laboratories; biographical sketches of prominent electrical scientists and inventors. All of these entries give the latest facts and figures on the topics covered and furnish much useful information that would often require considerable time and diligent search to locate.

All the editorial work on the book was done under the general direction of Frank H. Bernhard, who for fourteen years has been active on the editorial staffs of various electrical publications. Most of the technical topics were prepared by a staff of some thirty contributing editors, including college professors, electrical engineers and other specialists in their respective lines. These and other outside writers with the office editorial staff made a total of over sixty contributors to the book.

It is planned to revise the book completely and to add to it each year further industry information, definitions, products and manufacturers' listings. The book does not supplant the electrical periodicals, engineers' technical handbooks or students' textbooks. Its aim is declared to be to supplement all these by a carefully revised annual compendium of current facts and figures on the various electrical activities, of up-to-date definitions of electrical terms, and of classifications of products and their producers.

Practically every large industry has a year book containing a comprehensive trade directory of its products and manufacturers. The electrical industry now at last has this and more in the "E M F Electrical Year Book," whose reappearance each year will doubtless be looked forward to both by electrical men and by others interested in this big industry.

### 3AIC, Reading, Pa.

(Continued from page 304)

The long wave set is a DeForest honeycomb set with one stage of amplification. Between the sets is a switch for throwing from long to short waves. Hanging behind the set on the wall is an extra belt ready for instant duty in case the other one tears due to its terrific speed. In the center of the table is a two-gang box for plugging in either 110 or 220 volts A.C. Behind the table is a similar fixture giving 110 and 220 volts D.C. The phones used are three American types—Murdock's, Brandies, and Holtzer-Cabot—and two English types—Brown Adjustable and Sullivan. Marcuson "B" batteries are used.

We should be glad to hear from any amateurs who have heard us.

The instructor in Radio Telegraphy is Mr. J. Herbert Kissinger, who is also the instructor in Practical Electrical Construction.

### Junior Radio Course

(Continued from page 306)

counterpoise connected to the ground binding post of the sending set. It should be well insulated and may give better results than a closed circuit, but one should not expect a very long range, even with this form of coil antenna.

#### QUESTIONS FOR THIS LESSON

1. Explain the effect of a rectangular loop aerial.
2. What instruments are necessary for receiving with a loop aerial?
3. Which is the most efficient type of loop to use for direction finding work?
4. Is a loop aerial efficient for transmitting?

## 10c CHARGES YOUR BATTERY AT HOME WITH AN F-F BATTERY BOOSTER

and your station will never be closed because of a discharged battery. Is it not gratifying to feel that your filament battery will always be ready when you want it and that you will never have to give up in disgust when working a distant station?

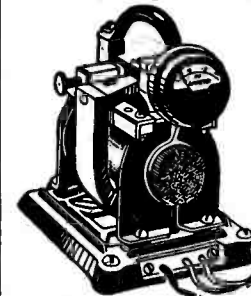

F-F Battery Boosters charge Automatically, Operating Unattended. Screw plug in lamp socket, snap clips on battery terminals and see the gravity come up.

The Ammeter shows you just the amount of current flowing. Both waves of current are rectified thru adjustable carbon electrodes which maintain a constant efficiency and last FOR THOUSANDS OF HOURS. EVERYTHING COMPLETE IN ONE COMPACT, SELF-CONTAINED, PORTABLE UNIT. F-F Battery Boosters are Magnetic Rectifiers for 105-125 Volt, 60 Cycle, Alternating Current. PRE-WAR PRICES: Bantam Type, 6 Charges, 6 Volt Batteries at 8 Amp \$15 Type 16 Charges 6 Volt Batteries at 8 Amperes...\$24 Type 166 Charges 6 Volt Batteries at 12 Amperes...\$32 Also BOOSTERS for 12 Volt Batteries at same prices. The Larger Types are for heavy batteries, or where time is limited.

Shipping Weights 10, 12 and 15 lbs. Order from your Dealer or Send Check for Prompt Express Shipment. If via Parcel Post have remittance include Postage and Insurance Charges. Or have us ship C.O.D. Other F-F Battery Boosters Charge batteries from Farm Lighting Plants & D.C. Circuits. For GROUP CHARGING use the Full Wave, Automatic F-F ROTARY RECTIFIER of 100 Volt, 98 coil capacity.

Order Now or Write for Free BOOSTER Bulletin No. 32 or ROTARY Bulletin No. 32A  
Offices & Works:  
**THE FRANCE MFG. CO.** Cleveland, Ohio, U.S.A.  
Canadian Rep: Battery Service & Sales Co., Hamilton, Ontario

## WIRELESS CATALOG

**JUST OUT** 10c in stamps or coin brings new loose-leaf catalog—100 pages, giving C.W. Hook-ups, Regenerative Hook-ups and all instruments needed for wireless receiving and sending sets—a broad range of prices—places you on mailing list to receive regular bulletins, keeping you posted on latest developments in wireless telegraph and telephone. Illustrations and prices on latest radio apparatus. Following is list of firms whose lines we carry in stock:

- |         |                  |
|---------|------------------|
| Acme    | Atlantic Radio   |
| Brandes | Coto-Coil        |
| Burgess | Connecticut      |
| Firco   | DeForest         |
| Pacent  | Halbauer         |
| Mignon  | Magnavox         |
| Radisco | Marshall-Gerken  |
| Signal  | Rhamstine        |
| Turney  | Ray-di-co        |
| Federal | Radio Corp.      |
| Murdock | Somerville Radio |

Write today for complete catalog.

### THE KUEBLER RADIO CO.

Successors to Retail Dept.,  
The Marshall-Gerken Co.  
80 Gibbs Bldg., Toledo, Ohio, U. S. A.

## Canadian Amateurs

Marvelous distances covered by C.W. Build your own Phone and C.W. transmitters with parts supplied by us at reasonable prices.

### Western Canada Radio Supply

Green Block, Broad Street, Victoria, B. C.

## ATTENTION!

Our STORAGE "B" BATTERIES give years of service without expert attention, saving you REAL money in the end. One charge lasts from three to six months in the detector plate circuit. All batteries shipped complete with rectifiers and full Directions.

Plain batteries with clips for adjustment at the following prices: 32 volts, \$8; 48 volts, \$10; 68 volts, \$12. With control panels 32 volts, \$10; 48 volts, \$12; 68 volts, \$15. Satisfaction guaranteed or money refunded.

**KIMLEY ELECTRIC CO.**  
290 Winslow Ave. Buffalo, N. Y.

## ANNOUNCEMENT

A. K. Laing, Radio Supplies and the Superlative Radio Co. have been combined to form

**A. K. Laing Radio Co. Pelham Manor, N. Y.**

INTRODUCTORY OFFER

\$1.50 list Ace "B" Batteries.....90c



### Overcoming the Gap Problem

(Continued from page 299)

where you use minimum resistance and maximum air gap and still have the synchronous spark. When this adjustment is obtained, you not only have a snappy synchronous note, but you have very good quenching because of the long spark gap used. The spark is quenched out rapidly because the gap is so wide that current can cross it only when the voltage is maximum. Thus the closed circuit is stopped oscillating and the antenna circuit oscillates freely on one wave-length. You now have all your juice in one place and it will come through far better than when spread all over. If a higher spark frequency is desired, reduce the gap length until an even double frequency note is obtained. However, this is not as efficient as the 60 ~ although it gives higher ammeter reading and draws more power.

With this system, closer coupling may be used because of the high quenching, and a sharp wave is easy to obtain. The only trouble encountered will be in keeping the wave on 200 with the big condenser needed.

You will notice in using this stunt that the ammeter reading has dropped considerably, but work on it a while, ask a few fellows how you come in, and you'll forget ammeter readings. A good many fellows hesitate about fixing their sets in this way because it seems to cut down their power input. It may do this, but it puts energy out at the antenna, and it is the output we are interested in.

A straight gap adjusted in this manner has been in operation at my station 2QY, along with and in direct comparison with a rotary gap, and here is the story told by the log:

*Rotary.*

Transformer used. Acme 8,000 V. 1/4 K.W.  
 Input-watts .....275  
 Antenna current .....1.2 amps.  
 Spark frequency .....240 ~  
 Maximum communicated reports .....30 miles

More QSA than plain gap (this report from nearby stations)

*Plain.*

Transformer used. Same as rotary  
 Input-watts .....50  
 Antenna current .....0.6 amp.  
 Spark frequency .....60 ~  
 Maximum communicated reports .....175 miles

Clearer and sharper than rotary at any distance heard; at many stations when rotary is not heard at all.

The plain gap has only been in operation a short time and the set has not been in operation during real "DX" weather or "DX" hours, so expect to cover even more distance with these snappy little 60-cycle—50 watts.

### 9G1 Weedman, III.

(Continued from page 305)

coils are homemade.

The only power available is 32 volts D.C. and an Amrad 100 watt induction coil and quenched gap combination is used for transmitting. Three sections of Murdock molded condensers are used, also Murdock O.T. and aerial switch. The radiation is 1 1/2 amperes as shown on a Roller-Smith HWA. The wave emitted is very sharp and up to 75 miles this station is reported as loud as 1-K.W. transformer transmitters. Stations 150 miles distant are often worked.

EVERETT C. SMITH, 9G1,  
 Weedman, Ill.

## WHY TAKE CHANCES

?

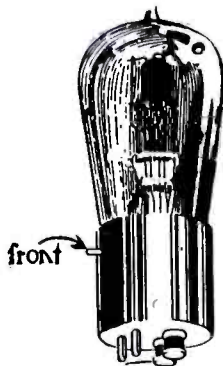

Carrying Capacity  
 1/4, 1, 1 1/4, 1 1/2,  
 2, 2 1/2 and 3  
 amp.

Order by Mail

If your dealer cannot supply you with "RA-DECO" Safety Fuses pin one dollar to this advertisement, stating sizes wanted, and receive FOUR fuses by return mail.

### How To Protect Your Vacuum Tubes

Blame yourself—not the tube—when an accidental short wipes out your Vacuum Tube at a sacrifice to money, time and efficiency.

With a Radeco SAFETY FUSE on the filament terminals of any standard bulb, you end unnecessary Vacuum Tube losses.

Radeco SAFETY FUSES operate like any ordinary fuse. Any high amperage circuit is broken before it can reach and destroy the delicate filaments.

SIMPLE! Slips directly on the filament terminals. It's easy. Efficiency guaranteed. Radeco SAFETY FUSES are equally necessary for protecting meters and other sensitive instruments. Equip your set at once.

We sell standard Radio equipment of every description. Order from any standard catalog. Immediate deliveries.

**RADIO EQUIPMENT CO.**

630 Washington St.  
 BOSTON, MASS.

## "RADECO" Safety Fuse

(Patent Pending)

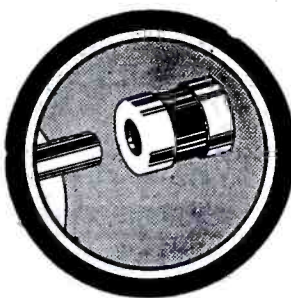

Don't wait until your Vacuum Tube blows out before you apply Radeco SAFETY FUSES to your tubes. Considering the small cost, is it worth the chance? TODAY—now—avail yourself of this tube insurance.

**\$1.00**

Sold by dealers, 4 for

## SOMETHING NEW

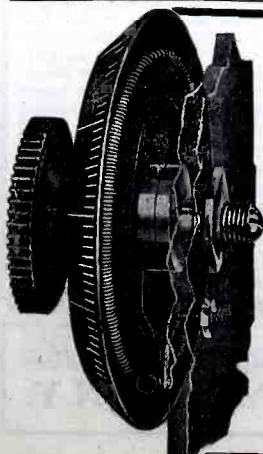

THE PARKIN DIAL TYPE RHEOSTAT (Pat. pending), consists of a 3 inch molded Bakelite dial in the back of which is a circular groove containing the resistance element. This groove, being recessed, allows the dial to clear the panel by the usual distance of 1/16 inch. An off position is provided, and a stop on the dial engages the stationary contact at the extreme positions. The 360 degree rotation insures fine adjustment. A brass bearing insures a true running dial and smooth action.

All figures and graduations are filled with brilliant white enamel. All brass parts nickel plated. Bakelite knob.  
 Resistance is 5 ohms, carrying capacity 2 amps. No. 77 Parkin Dial Type Rheostat, postpaid .....\$1.75

FOR SALE BY ALL LEADING DEALERS

Send for free catalogue No. 5 describing our complete line. Dealers—Write for proposition.

**PARKIN MFG. CO. — SAN RAFAEL, CALIF.**



**A  
ACE  
E**

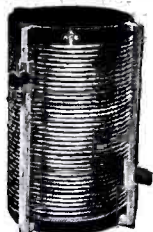

**A  
ACE  
E**

ACE C.W. Inductance, Complete, but without sliders, \$5.00.

ACE Receiver Cord Binding Post, nickel plated, pair, 35c.

The ACE CW Inductance is unquestionably the ideal unit for amateur experimental work in connection with CW Circuits. Comprises 40 turns of No. 10 HD bare copper, space wound on a heavy formica tube 4 1/4" o.d. Two heavy phosphor bronze sliders moving on solid 1/4" rods permit of single turn variation and assure positive electrical contact.

The ACE Receiver Cord Binding Post eliminates the harmful "cross pull" resulting when ordinary binding posts are employed. This condition causes excessive wear and tear to take place near the terminals or tips of the cord, eventually resulting in breakage. The ACE Post protects your cords and provides for a positive electrical connection.

We Carry in Stock at All Times a Complete Line of Radio Accessories  
Send 3c in stamps for catalog.

**THE PRECISION EQUIPMENT CO.**

MEMBER A. R. R. L. Incorporated **RADIO 8 X B**  
Manufacturers of Ace Radio Products  
Peebles Corner, Cincinnati, Ohio  
"YOU MAY PAY MORE BUT YOU CAN'T BUY BETTER"

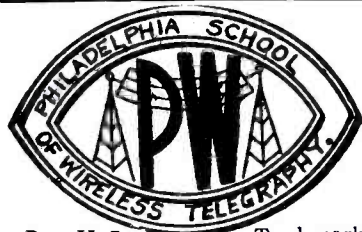

**HAS THE LATEST**

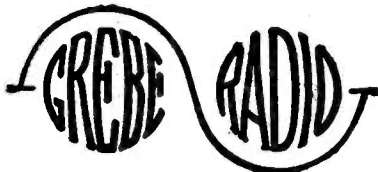

Reg. U. S. Trademark

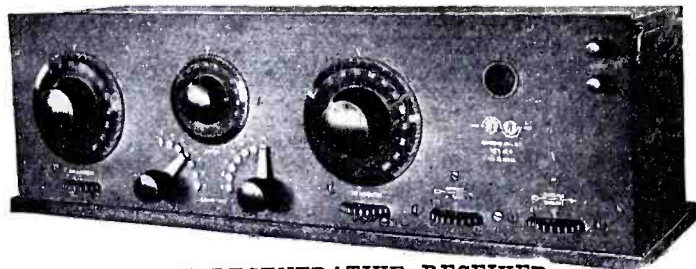

CR-8 SHORT-WAVE REGENERATIVE RECEIVER

is one in which perfection in even the minor details has been attained. It is indeed a masterpiece. Just look at these new features! Exclusive, every one of them:—

- New moulded variometers—that will last a century.
- Rubber-tired Verniers—make real tuning a pleasure.
- Aluminum shields eliminate troublesome change of frequency when receiving C.W.

Direct reading wave-change and rheostat controls.  
Battery binding posts in the rear—eliminating unsightly connections.  
Constant calibrated wave-length range—150 to 1,000 Meters.  
If it were possible to make a finer short-wave regenerative receiver, Grebe would be making it.  
Your dealer will gladly order one of these receivers for your inspection. Ask him for bulletin. CATALOG R FREE.

Philadelphia School of Wireless Telegraphy, 1533 PINE STREET PHILADELPHIA, PA.

**DON'T READ THIS**

If you are a millionaire  
Aerial Wire 7-22 Pure Copper at, 75c per 100 Ft.  
No. 14 Pure Copper Aerial Wire, 50c per 100 Ft.  
Amplifying Transformers (mounted) \$3.45  
Detector Panels, reg. price \$12.00... 7.00  
Amplifier Panels, reg. price, 18.00... 11.50  
Two-step Amplifiers reg. price \$35... 22.00  
6 Volt 100 Amp. Hr. Storage Batteries ..... 22.00  
Special one-half price sale on all kinds of magnet wire.  
Write for our catalog.  
Attractive proposition for dealers.  
Wilmington Electrical Specialty Company  
705 Adams Street Wilmington, Del.

GET THE NEWEST BOOK ON RADIO MATTERS ENTITLED

**The How and Why of Radio Apparatus**  
By H. W. Secor, E.E.

This book fulfills a distinct gap in wireless literature. It incorporates a wealth of technique and instruction for the Radio Amateur—the Radio Operator—the Installation and Designing Expert—as well as teachers and students of the subject in general. If you are engaged in any branch of the Radio or allied arts at all you will surely need this latest contribution to radio literature, which is destined to be found on every radio man's book shelf before long.

An appendix containing very useful tables, covering all subjects treated in its columns will be found in this very unusual book. Cloth bound in Vellum de Luxe, Gold Stamped and Hand Sewed. 160 pages. Size of book 6x9 inches. Postpaid \$1.75. Experimenter Publishing Co., Book Dept., 236a Fulton St., New York City.

**Transatlantic Reception Par Excellence**

(Continued from page 283)

end of which time the wire sank into the snow and the signals gradually faded out. The conditions had been just right for this experiment, viz., frozen ground, with dry hard snow above. Mr. Fabbri then again called on the Wireless Specialty Apparatus Co. for help and as a result Mr. Greenleaf W. Pickard of that company installed a combined static neutralizer and directional reception at Otter Cliffs.

This system worked perfectly and it soon became evident that Otter Cliffs was copying 100 per cent. schedules while the other stations of the system were handicapped with increasingly heavy static. It was obviously a fallacy to operate a number of stations to do the same work that could be done by one, so the other stations were abandoned and four stations were installed at Otter Cliffs, side by side, and simultaneous reception carried on from the following European stations: Rome, IDO; Carnarvon, England, NCI; Lyons, France, YN; Nance, France, UA; Hanover, Germany, OUI; Nauen, German, POZ; Horsea Island, England, and Liverpool. Madagascar was frequently heard, although not regularly worked.

Using a two-step amplifier normal signal strength from the above stations was over 1,000 times audibility. In order to let Mr. Pickard hear the signals in Boston, Mr. Fabbri frequently called Boston on the long-distance phone and the signals from Europe were plainly audible in Boston.

The Otter Cliffs Station, as shown in the photographs was, and is now, 100 per cent. perfect in reception. In other words, it has the same reliability of service as the cables, 24 hours a day. An additional spur in obtaining this efficiency was the well-grounded fear that the Germans would attempt to cut all the cables, a comparatively easy matter where all of the same 18 or 20 European cables pass through the shallow water of the Irish coast. As a matter of fact, evidence is at hand that they did actually succeed in cutting two cables.

The total force required to operate the Otter Cliffs station is about 200 men. Two men are on watch at each of the four stations all day and all night. By having two men in each station copying simultaneously, mistakes in reception are minimized.

The antenna of each of the four stations, as shown in the photograph, consists of a loop of four turns of No. 16 copper wire. The loop is in the form of a rectangle about 100' long with the top part about 20' and the lower side only 12' above the ground. The loops are so placed as to obtain the best directional effects from the European stations. The circuit used in this station, together with its description and method of operation, are completely shown and described in Mr. Greenleaf W. Pickard's article on "Static Elimination by Directional Reception," which appeared in the January issue of RADIO NEWS.

**The Hulbert Transrectifier**

(Continued from page 294)

ter. The possibility of working up a selective system of telephony by the Hulbert transrectifier method is a reality. The quietness and rapidity with which the transrectifier responds is a characteristic of its compactness and simplicity.

For X-ray work there is no other inexpensive electrical apparatus to equal it; 100 to 30,000 volts high potential direct current have been tried on evacuated tubes and it is possible to get any potential direct

Insure your copy reaching you each month. Subscribe to *Radio News*—\$2.00 a year. Experimenter Pub. Co., 236-A Fulton St., N.Y.



current, no current or very little current if desired. By reversing the direct current control, the pulsating direct current potential can be reversed showing an exchange of colors in an evacuated tube containing a gas.

The application of industrial and educational institutions is another unlimited field for high potential direct current. The value of having high potential direct current to compare with high potential alternating current cannot be estimated. Chemical and physical research laboratories have wanted high potential direct current for a number of years. The quality of high potential direct current for testing and research work is another value which cannot be estimated. Each kind of electrical current has its qualities, but high potential direct current has qualities second to none.

**A Universal Panel Type Receiving Set**

*(Continued from page 300)*

condenser, which is mounted just under it. On the right is the complete regenerative set, with unit and ten switches for the primary of the variocoupler.

**A New Type of Variometer**

*(Continued from page 300)*

segments should be of exactly the same length, with about  $\frac{1}{8}$ " spacing.

The brushes should be placed in such a position that they are in the spacing between the segments when the windings coincide. The method of connecting up the brushes and commutator segments is shown in Fig. 4.

Care should be taken when assembling the variometer, that the windings are directly underneath each other (longitudinally), otherwise the full effect of the variometer will not be obtained. No rod is necessary for the rotation of the variometer, as the guides for the wire will be sufficient for the inner tube to wear on; all that is necessary is to fasten a knob to the inner tube.

A vario-coupler can be constructed along the same lines as this variometer, with the exception that half of the secondary winding should remain outside of the primary winding. The brushes and the commutator may be omitted, but several taps must be taken from the primary.

**Complete Radio Receiver for Beginners at a Popular Price**

*(Continued from page 288)*

and time signals as well.

This receiver is herewith shown, and is furnished with all the necessary parts to erect a complete receiving station, including a little manual outlining the general principle of Radio reception and giving full directions to erect the set, with such details that anyone can do it.

This receiving outfit will prove especially valuable to Boy Scouts and others who are interested in Radio, but cannot afford expensive apparatus and do not know exactly what is necessary to receive Radio signals. Furthermore, being portable, it will prove useful for demonstrations in different places and may be carried out during a vacation or excursion in the open.

The set is not a toy, but a real well-built instrument and was designed by Mr. Joseph D. R. Freed, a Radio engineer who has had a long experience in the manufacture of commercial Radio apparatus; this alone is a guarantee for the buyer of the outfit who gets an instrument which has been carefully tested before it is delivered, the same as any expensive apparatus.

*Photo by courtesy of the Radio Mfg. Co.*

**KENNEDY EQUIPMENT**

**Announcing**

the New

**KENNEDY INTERMEDIATE WAVE REGENERATIVE RECEIVER**

Type 220

**RANGE 175 TO 3250 METERS**



Detects  
Regenerates  
or Oscillates  
as desired over  
entire range.

Licensed  
under  
Armstrong  
U. S. Patent  
No. 1,113,149

A unit worthy of the Kennedy trade-mark.

We believe that there is no other receiver on the market displaying such concentrated quality value in design and finish, workmanship and performance.

See it at your dealer's. Examine it thoroughly, have a demonstration, and form your own opinion. We don't ask you to accept ours.

*Bulletin 201, giving full description, will be mailed on request*

*Ask your dealer*

**THE COLIN B. KENNEDY COMPANY**

INCORPORATED

RIALTO BUILDING

SAN FRANCISCO

**NORTHERN ELECTRIC C-W APPARATUS TWO NEW C-W UNITS**

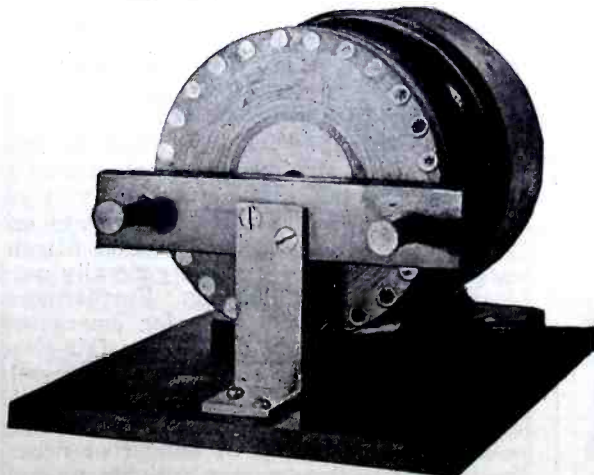

The ROTARY MODULATOR illustrated is the most efficient device you can use for tone transmission with power tubes. Many stations are using these tone wheels and they certainly cut thru Q.R.M.

A C-W OSCILLATION TRANSFORMER, designed especially for Radiotron power tubes, is now available. Made with heavy copper strip and genuine hard rubber insulation, yet it only costs \$8.00.

A postal will bring our latest catalogue. Tell us your technical troubles. Our Eng. Dept. is prepared to render a real service to those erecting new stations. There is no charge for this service.

**NORTHERN ELECTRIC COMPANY**  
P. O. Box 371 SCHENECTADY, N. Y.





## MAGNET WIRE

We carry in stock at all times the highest grade magnet wire and can quote the following prices:

PER 1/4 LB. SPOOL

Size	Single Cotton	Double Cotton
No. 18	.23	.25
No. 20	.25	.27
No. 22	.29	.31
No. 24	.30	.33
No. 26	.33	.38
No. 28	.37	.41
No. 30	.49	.52
No. 32	.62	.65
No. 34	.89	.93
No. 36	1.21	1.30

For 1 lb., 1/2 lb. and 1/8th lb. spools, proportionate prices. These prices are net, include the cost of spool, postage and guaranteed safe delivery.

*Aerial Copper Wire No. 14  
Special at 50c pound*

Complete line of standard radio equipment always in stock. Write for our new catalogue, No. 2.

### Dreyfuss Sales Corp.

"WIRELESS AMATEURS HEADQUARTERS"

179 Greenwich St., Near Cortlandt St.,  
NEW YORK CITY

## RHAMSTINE \*



**Rhamstine\*  
Vacuum Tube Socket \$1.00**  
ADD 4c FOR POSTAGE

This socket is the result of careful designing and mechanical skill in producing. The plated and polished shell is mounted on a black condenser-celoron base. Binding posts are outside, making them very accessible. The unit is attractive, sturdy and durable. Ask to see it at your dealers or order direct.

**Rhamstine\* Plug and Jack—Complete \$1.50**  
ADD 4c FOR POSTAGE

**Rhamstine\* Amplifying Transformer \$3.50**  
POSTAGE AND PACKING 10c

Circulars on request. Dealers write for discounts.

Manufactured by

**J. THOS. RHAMSTINE\***  
2152 E. Larned St., DETROIT, MICH.

\*Radio Products.

Just what you want for coil winding. Made in four and seven inch swing. Eleven and eighteen centers. Face plate and drill chuck also furnished. Workman-ship first class thruout.



Prices ranging from \$6.00 to \$11.50. Write for special catalog today.  
SYPPER MFG. CO.  
Dept. A Toledo, Ohio

## The Vaughan Radio-Controlled Car

(Continued from page 295)

farmer sought repose on his front porch. Then, too, if the tractor could be guided unerringly along the unbroken furrows, the classic phrase, "the ploughman homeward plods his weary way," would be thrown into discard. The tractor, accepting the somewhat far-fetched suggestion on its face value, could be directed by radio-control into the garage at sundown.

## Radio Reception at Ketchikan, Alaska

(Continued from page 295)

sel would repeat the message or any part of it, VAE would say: QRM, OM SORI QRZ also PSE RPT. Undoubtedly this got on the nerves of both the operators, it should have, at least. Well, the steamer was very QSA at 7IT and so was Estevan. The writer reasoned that the boat was directly west of Ketchikan, and only a few hundred miles at that, as the steamer was coming to Seattle from Japan and was evidently coming over the Great Circle route. It, therefore, seemed funny the Estevan was reporting signals QRZ. Suddenly, however, the steamer's signal strength died out so as to be barely audible at 7IT. This never took more than two seconds. When the boat operator stopped sending, VAE reported: very QSA NU OM GA NXT MSG.

What caused this? Was there some intervening mountain or mountain range that came between the vessel and VAE and which later was between the boat and 7IT? In a way, it sounds plausible, and in a way it does not. However, the former conjecture is probably true.

It might be well to state here that not more than once or twice has fading been experienced at 7IT, that is, so as to hinder reception.

There are several stations situated on the Alaska coast which are heard at 7IT and not at the local station, and vice versa. The lighthouse tenders *Fern* and *Cedar*, stationed at Ketchikan, are also able to hear many stations not heard by 7IT or the local station, or by both of these, and some are heard by 7IT and NVH that neither of the lighthouse tenders are able to hear. Why is this? When in port both the lighthouse tenders are plainly seen from 7IT and they are no more than two miles from NVH. It might be well to state that the *Cedar* uses two stages of amplification, the *Fern* uses one stage, NVH uses two or more stages, while 7IT uses none, only a tube detector.

## Is the Storage Battery to be Replaced as a Source of Auxiliary Power for Marine Radio?

(Continued from page 280)

obtains where gasoline is used for such purposes.

### THE UNIT ITSELF

The machine illustrated is rated to supply 1,500 watts and its voltage at normal is the same as the ordinary ship's voltage, namely 110. This is enough power to operate a 1-K.W. transmitter at 100 fifteen-watt lamps, which is the size generally used for emergency ship lighting. Furthermore, 100 lamps, used exclusively for emergency purposes, is the quota for a very fair-sized vessel. On most of the passenger vessels which ply our coast there are considerably less than that number, so that the unit may be relied upon, in case of danger or necessity to operate the emergency lights, as well

## KEYSTONE WIRE

Wire for every Wireless Purpose

## MAGNET WIRE

We are prepared to furnish best grade magnet wire on 1/4 and 1/2 lb. spools at the following revised prices:

PRICE PER 1/4 LB. SPOOL

B&S Ga.	Single Cotton	Double Cotton	Single Silk	Enameled
No. 22	\$0.56	\$0.68	\$0.82	\$0.45
No. 24	.60	.77	.87	.47
No. 26	.65	.88	.71	.49
No. 28	.75	1.10	.85	.52
No. 30	.85	1.24	.97	.53
No. 32			1.15	.55
No. 34			1.52	.59
No. 36			1.77	.69

Price on 1/2 lb. spools double above list.

All prices are net and include cost of spool and delivery charges via Parcel Post to any Post Office address in the United States; safe delivery guaranteed.

Send for Circular 21-A giving prices on other sizes, insulations and quantities of Magnet Wire. This circular lists "WIRE FOR EVERY WIRELESS PURPOSE."

Dealers—write for our proposition.

## KEYSTONE WIRE COMPANY

P. O. BOX 120 SCRANTON, PA.



## RADIO

### TELEPHONE & TELEGRAPH APPARATUS OF MERIT

K20A Rotary Enclosed Gap.....	\$25.00
K20B Same without motor.....	20.00
K1 Open Rotary Gap.....	16.00
UV200 Radiotron Detectors.....	5.00
UV201 Radiotron Amplifiers.....	6.50
UV202 5-Watt Transmitter.....	8.00

Send 4c for our 55-page Catalog. Full of illustrations, information and prices that will prove attractive

### KARLOWA RADIO CO.

611 Best Bldg., Rock Island, Ill.

## GENERAL MACHINE WORKS

Mechanical or Electrical General Manufacturing, Experimental Work, Telephone and Wireless parts manufactured, Tools, Fixtures, Dies, Jigs, etc., Stamping.

Engineering Dept. of

**G. Boissonnault Co., Inc.**  
26 Cortlandt St. New York

Factory  
WHITESTONE, L. I.

## WE "PICK UP" YOUR S. O. S.

for any apparatus from a complete station to a 3-cent contact point.

Radiotron Tubes.....	\$5.00
Paragon Rheostat No. 25.....	1.75
Chelsea Dials 3 3/4".....	1.00
Tested Galena.....	.20

Write for list.

**INDIANAPOLIS RADIO SUPPLY COMPANY**  
3023 Boulevard Place Dept. C. Indianapolis, Ind.



as the radio equipment. Units of greater power are to be had, but we will merely consider the performance of this particular outfit.

The transmitter shown in one of the accompanying photos is rated 6/10 T.K. by its makers (Telefunken) and corresponds very closely to the American rating of 1 K.W. It was operated on full power with all the emergency lights burning and the drop in voltage was negligible. When the emergency lights were turned off and the set operated at full power, there was even less of a voltage drop and the effect of transmitting was so well taken up by the governor on the machine that no change could be noticed.

A detailed description of the machine would merely be a repetition of the same general characteristics to be found in machines of this type, which find their greatest utility in farm lighting, but there are unique points in its operation which are very interesting. After the machine has been installed and wired properly, it is but necessary to turn on the current in any part of the ship the generator is to supply and it starts the gasoline engine. Whether you are in the radio shack, engine room, on the bridge or in one of the staterooms, so long as you can turn on one of the lights or throw the switch on the radio outfit, the generator will start itself. This is made possible by a special wiring scheme which controls the output of an automobile starting battery. As soon as the battery has turned the engine over and the explosions begin to take place in the cylinders, the battery is automatically cut off and the current from the dynamo is directly connected to the supply lines. The time necessary for the machine to develop normal running, from a standstill, is less than four seconds. The machine will then keep right on running until every light has been turned off or the gasoline runs dry in the tank. A suitable governor serves to compensate for variations in the load and an actual test given one of these units by the author, after it had been inoperative for considerably more than 24 hours, proved conclusively to him that it made no difference whether only a 15-watt lamp or the radio transmitter, which consumed considerably more than 1,100 watts on starting was in circuit when the starting switch was thrown in. The action of the governor is very precise and it was surprising to see how uncannily the machine followed the will of the operator when rapid changes of the load were made. This machine really seems to have brought the auxiliary problem to the point where the radio man merely has to turn on the switch in the radio shack and there is a source of unfailing power available for his demand, limited only by the amount of gasoline kept in the tank. Equipped with an external exhaust, the machine is almost noiseless in operation and when used on shipboard the noise it makes is entirely drowned out by the noise of the main engines. Of course it is not necessary to confine the installation to the engine room, but that is the logical case and, as has been proven by the *Relief*, is entirely a satisfactory arrangement.

#### THE RADIO CABIN ON THE RELIEF

Many of the old-time commercial operators will recognize the equipment used for the transmitting set on the *Relief*, as being a Telefunken set which has been trimmed up a little. The bank of leyden jars, which in bygone days used to make the set look so well with its nickel-plated surface, is no longer to be seen. This has been substituted by the modern mica and copper foil condensers, which serve the purpose just as well, break down less frequently and take up a great deal less room. The transmitter is adjusted to four wave-lengths 300, 450, 600 and 800 meters. By following the leads it is possible to see that the cir-

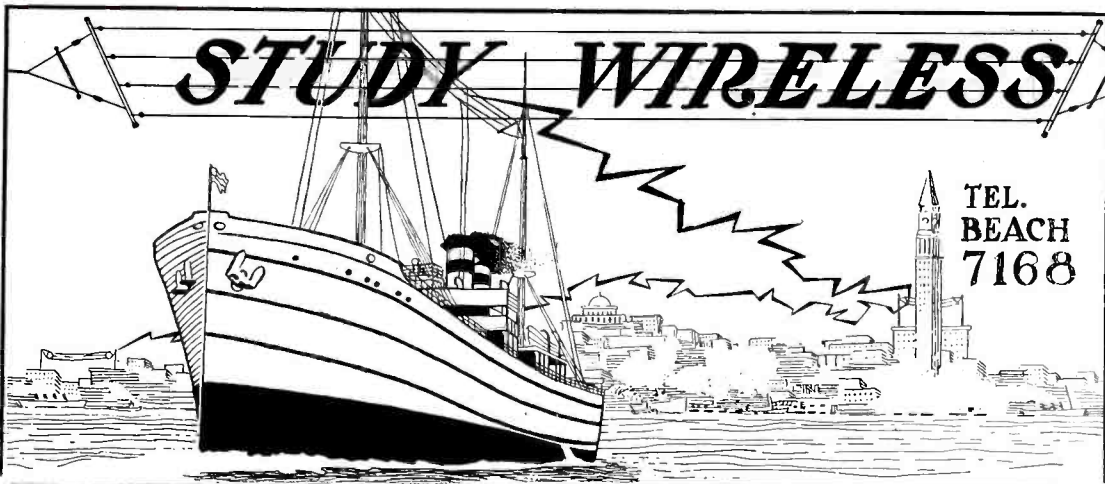

### The Oldest Wireless School in New England

Formerly the Boston School of Telegraphy, established in 1903. The home of Boston's first Wireless Station, when a De Forest Transmitter was installed at 18 Boylston St. in 1907.

We teach RADIO and TELEGRAPHY exclusively.

## Results Count!

Did you know that the Massachusetts Radio & Telegraph School produced *more* Licensed First Grade Commercial Operators during the first six months of 1921 than any other wireless school in New England?

Did you know that these men were trained in a *shorter* time and obtained *higher* marks on their government examinations than students from other schools?

Did you know that the Massachusetts Radio & Telegraph School established a *record* for the entire country by producing 22 graduates during a single month who obtained their first grade licenses?

Did you know that 50 graduates averaged 80% out of a possible 90% on their government examinations?

Send for our 44-page catalogue containing full information for prospective wireless students.

Fall Term, both day and evening classes begin Sept. 12.

GUY R. ENTWISTLE,  
Director of Radio

**MASS. RADIO and TELEGRAPH SCHOOL**  
18 BOYLSTON ST. COR. WASHINGTON ST., BOSTON  
Dept. A *Send for FREE Catalogue* Dept. A

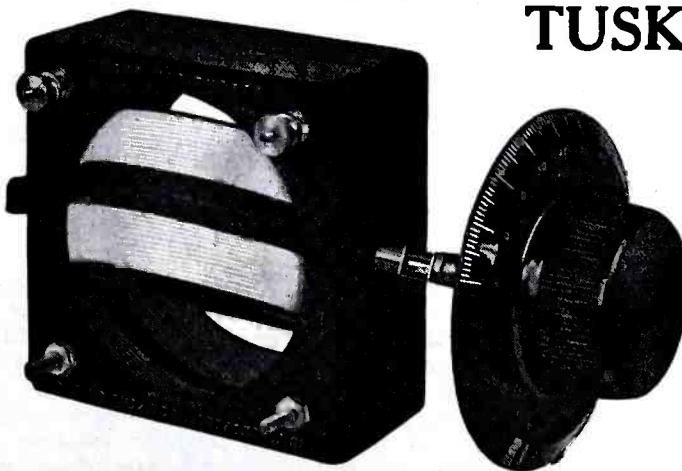

TYPE 200

PRICE \$7.25

## TUSKA MOULDED VARIOMETER

*Mechanically and Electrically Peerless*

See them at your dealer's

Send 5c for Catalog No. 2

Receiving Sets, Knobs, Dials, Variometers, Variocouplers, C.W. Inductances, C.W. Transformers.

The C. D. Tuska Co.  
HARTFORD CONN.

### COMPARE THESE PRICES

Triple Honeycomb Mounting (For panel Mounting)	\$5.00
Variometer Wood Parts (Unassembled and Unmounted)	2.00
Miniature D.P.D.T. Panel Switch	1.00
Vario-coupler Rotor	.60

Send 10 cents for Bulletin and future announcements.

PARAGON ELECTRIC COMPANY  
215 North 6th Street, B. Newark, New Jersey

### CARDBOARD TUBING

In any length up to 25"  
3" and 3½" Dia. 2½¢ per inch or fraction—  
25¢ per foot; 4" and 4½" Dia., 3¢ per inch or  
fraction—30¢ per foot; 3", 3½" and 4" has ½"  
wall; 4" has 5/32" wall.  
Postage extra—Shipping weight about 1½ lbs.  
per foot. Circular for stamp

JEFFERY-CRAWFORD CO.  
2173 Hillger Ave. Detroit, Mich.



## GET A WIXICO

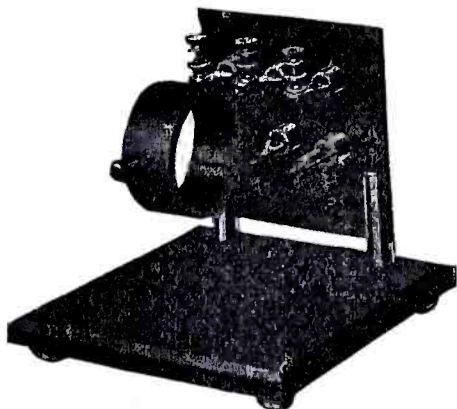

### COIL MOUNTING

Pat. applied for

and bring your set up-to-date.

WRITE FOR PARTICULARS

Table Type Mounting.....	\$8.00
Panel Type Mounting.....	6.00
Plug Complete with Handle and strap..	.70

Above does not include coils. Plugs fit only WIXICO Mounting but are sold separately if desired.

See your dealer or write us.

We also handle a complete line of Radio apparatus. Send 4 cents for our catalog. Write us your wants.

**THE AMOLECCO CO.**  
CINCINNATI, OHIO

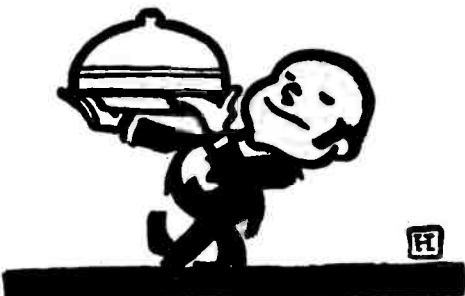

We carry a full line of all Radio Apparatus advertised in this Magazine.

B. Bat. Small.....	\$1.25
Murdock Phones.....	4.50
Fada Rheostat.....	1.25
Murdock Socket.....	1.00
Chelsea Condenser.....	4.50
Chelsea Dial.....	1.00
U.V. 200.....	5.00
U.V. 201.....	6.50
U.V. 202.....	8.00
Vocalloud.....	30.00
Brass C.P., One Dozen.....	.35
Grid Condenser.....	.35

**KELLY & PHILLIPS**  
312 Flatbush Avenue  
BROOKLYN, NEW YORK

AMPLIFY YOUR RADIO SIGNALS WITH



Practical Instruments for Commercial & Scientific Purposes  
Super-Sensitive Detectagraph Transmitter No. 2, Price \$8.00 complete.  
Adjusted Model No. 60 Horn, High Grade Loud Talking Receiver, Cord Plugs and Desk Stand Base, Price \$15.00 complete.  
Our New Special Loud Talking Receiver No. 25, Price \$7.50.  
Detectagraph Rheostat, especially made for amplifying circuits, Price \$2.00 complete.  
Write for our free descriptive new catalog showing our complete Super-Sensitive Hearing and Talking Devices

**G. BOISSONNAULT COMPANY (Inc.)**  
25 Dey St., New York City  
Factory: Whitestone, L. I.

cuit is close coupled. The twin pancakes on the wall, which would serve very well as an oscillation transformer for amateur station, in this case are used together to form a variometer for fine wave-length adjustment. The transmitter is designed to operate on a 500-cycle supply. Transmitters of this type have done some very fine work, especially those which were installed on the Panama Line several years ago. When the station down at the Battery, in New York, was operated by the *N. Y. Herald*, some of these ships communicated directly with it from Colon, Panama.

The receiving set is an entirely new development of the Kilbourne & Clarke Company, which covers a wave-length range of 150 to 12,000 meters. The receiver is provided with a "wave trap" circuit for eliminating interference from undesired transmitting stations as well as from static.

All in all, with all these new and improved features, it would seem as though the *Relief* is a pretty desirable berth for any radio man. That automatic generator thing almost makes a fellow feel like packing up and having a good old trip to no place in particular, where the smell of the ozone is thick and there is plenty of QRM to fume over and you don't have to salaam to some chief engineer when you want the juice to get a TR ashore.

### Construction of a C. W. Power Transformer

(Continued from Page 298.)

always think in terms of induced volts. Also since these voltage are known, we may solve the equation for some other factor, such as n, the number of turns, or o the flux in the core, as f will be known for any specific purpose, being 60 cycles in most cases.

We may assign any value to either n or o, but to prevent the transformer from becoming ill proportioned we had better consult a little table which represents good practice and which gives the proper value of volts per turn for transformers of various ratings or power outputs in watts. We will consider in this table only the case of transformers to operate on the almost universal 60-cycle alternating current supply. For other frequencies the voltage per turn should vary about as the frequency, for all commercial frequencies.

Rating in Watts	Voltage per Turn
50	1/8
200	1/4
500	1/2
1,000	1

This table will determine the number of turns needed for primary and secondary and so we can proceed to the determination of the other unknown o. The formula, by a slight change, reads  
 $o = V \times 100,000,000$  (all known except o.)

$$4.44 \times 60 \times n$$

For the low frequencies under consideration the flux is so large that it is imperative to use an iron core permitting a large flux in a small area. For this purpose two kinds of iron are available, generally; "stove pipe iron" and the regular silicon transformer steel. For stove pipe iron, the value of o may be about 40,000 "lines per square inch," and for silicon steel it may be about 70,000 "lines per square inch." In either case the core loss will be about one watt per pound of core, a nominal and safe value.

Iron transformer cores must be laminated or subdivided to reduce the eddy currents, which in a solid core would be a source of large power loss and heating. So the core is built up of strips of sheet iron, which are varnished on both sides to afford an insulating film that will pre-

### THE IMPROVED VICTOR PIN SOCKET

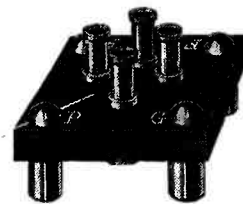

Insert tube prongs in slotted pins and you get a contact surface of 3/8" x 1/4" positive and permanent. Fused with new type fuse on each filament and plate lead. You can't

#### "PUT OUT THAT LIGHT"

1 1/4" screws at corners for mounting and connecting. 1/4" machined Bakelite base. Lettered and filled with white as shown. N. P. screws and supports. The price is \$1.00 by mail post paid, and it's worth it. If you want to mount your own, pins only 10 cents each. Extra fuses new copper mica type, 10 cents each. State tube. SPECIAL 3 SOCKET MOUNTING. Lettered for leads and det. 1-Amp., 2-Amp., on 1/4" machined base. Fused of course. A well made beautiful unit just the thing for det and 2 step Amp.. 7 1/2" by 2 1/4" overall, postpaid, \$4.50. Three contact plug. Mounted in bakelite. Off-set type. You can't insert wrong. Use 3 slotted pins for jacks. Fine for 6-40 volt control. \$1.00 postpaid. Fuse block with any desired capacity fuse (double), 50 cents P.P.  
Radio Clubs Write for Special Prices on Above.

**V. H. LAUGHTER**  
P. O. BOX 78

MEMPHIS TENN.

### \$5. Audion Panels \$5.

Panel is lettered, has grid leak and condenser, dial, posts for tickler, etc. Send 3c in stamps for enlarged lists about this and others.

50c For AUDION BULBS 50c

"ARK" RADIO SUPPLY  
97 Hill St., Dept. A SHELTON, CONN.

#### ATTENTION:

Get our bulletin describing the Sterling Honeycomb coil mounting. Rubber binding posts 8 cents each. No. 14 hard drawn copper wire 45 cents per pound postpaid. Get our bulletin of other useful parts.

**Sterling Radio Equipment Co.**  
2723 Cooper Avenue, Brooklyn, N. Y.

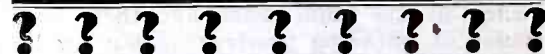

Let us answer your difficult questions. Our service includes queries on the following:  
Transmitting and receiving sets, hook-ups, disinterested description of new apparatus for prospective purchasers, CW apparatus, fones, amplifiers, tubes, etc.  
**PROMPT SERVICE—ANSWERS SENT DAILY**  
One question 25 cents, each additional one 15 cents, three for 50 cents.  
RADIO, 212 E. Green St. Champaign, Ill.

### RADIO CLUB PINS

Radio Clubs Everywhere have a special club pin. We make them to order, 25c to \$10.00 each. 1922 catalog of 48 pages showing designs of Radio School and Fraternal pins and rings FREE. Samples loaned to officers.  
**METAL ARTS CO., INC.**  
7755 South Ave. Rochester, N. Y.

You can be quickly cured, if you  
**STAMMER**  
and 10 cents for 288-page book on Stammering and Stuttering, "Its Cause and Cure." It tells how I cured myself after stammering 20 yrs. B. N. Bogue, 875 Bogue Bldg., 1147 N. Ill. St., Indianapolis.

**TELEGRAPHY**  
(Morse and Wireless) and RAILWAY ACCOUNTING taught thoroughly. Big salaries; great opportunities. Oldest, largest school. Endorsed by Telegraph, Railway, Radio, and Government officials. Expenses low—opportunities to enter large portion. Catalog free. **DODGE'S INSTITUTE.** 8 Street, Valparaiso, Ind.



vent the flow of the eddy currents, which, it will be noted, follow a path similar in direction to that of the current in the coils.

A square cross-section is best for the core as, for a given area, a square has the shortest perimeter of all four-sided figures and so permits the shortest mean length of turn in the windings and hence the greatest economy and efficiency.

Good proportions will generally demand that the width of the "window" in this type shall be from two to three times the width of the core laminations and the length of the "window" from four to six times the lamination width. This is based on the provision of sufficient space for the windings, proper clearance between coils and adequate ventilation.

A core of this type may be built up using only two sizes of laminations, one having a length equal to the width of the window plus the width of the laminations, and the other having a length equal to the length of the window plus the width of the lamination. A stack of each size, twice the height of the lamination width, will suffice. Each lamination should be varnished, the thinnest coating being sufficient as the eddy current voltages are very low. When assembled in a core, as shown in the figure, lapping the joints in each consecutive layer, the laminations are tightly clamped between strips of wood or iron. If the latter are used, they should be insulated from the core by cardboard or other material. Through bolts at the end of the strips are a convenient means of getting the necessary pressure.

For a conservative rating it will be best to have the windings made with wires that afford from 800 to 1,000 circular mils per ampere. The sizes necessary may be determined by reference to a wire table for the B. & S. gauge (not a Fire Underwriters' table of carrying capacity).

The dimensions of the coils may be determined in the following way. The diameter of double cotton covered wire is 8 to 12 mils more than the bare diameter. The number of turns per layer and the number of layers may thus be calculated from the covered diameter and the number of turns. A space of  $\frac{1}{4}$ " or  $\frac{1}{2}$ " at each end of coil will provide necessary clearance between coil ends and core. A single warp of varnished cloth between layers will facilitate the winding and provide additional insulation. Ordinary voltages up to 1,000 or 2,000 may be taken care of in layer-wound coils of this description. For higher voltages the windings may be made in sections of about this voltage per section with insulation between sections. With heavy wire the windings will be self-supporting, but for smaller than No. 24 wire the winding should take the form of a spool with ends to hold the end turns in position.

The winding form may be as follows: A block of wood of the same dimensions as one long leg of the core, should be mounted on a shaft by means of a hole through the center from end to end. A layer of heavy cord on this block will provide the  $\frac{1}{8}$ " or  $\frac{1}{4}$ " clearance all around between coil and core that is necessary for ventilation and core assembly. A square cardboard or fibre tube should be built on this with a  $\frac{1}{8}$ " or  $\frac{3}{16}$ " wall. With the shaft mounted between a pair of simple bearings the winding may then be accomplished easily by either hand or power drive. For small wire, spool ends may be added to the tube. Short lengths of flexible wire should be soldered to the magnet wire for leads, particularly in the case of small wire which is easily broken. All other internal connections should be well soldered and insulated, too.

The length and quantity of wire for windings may be determined from the

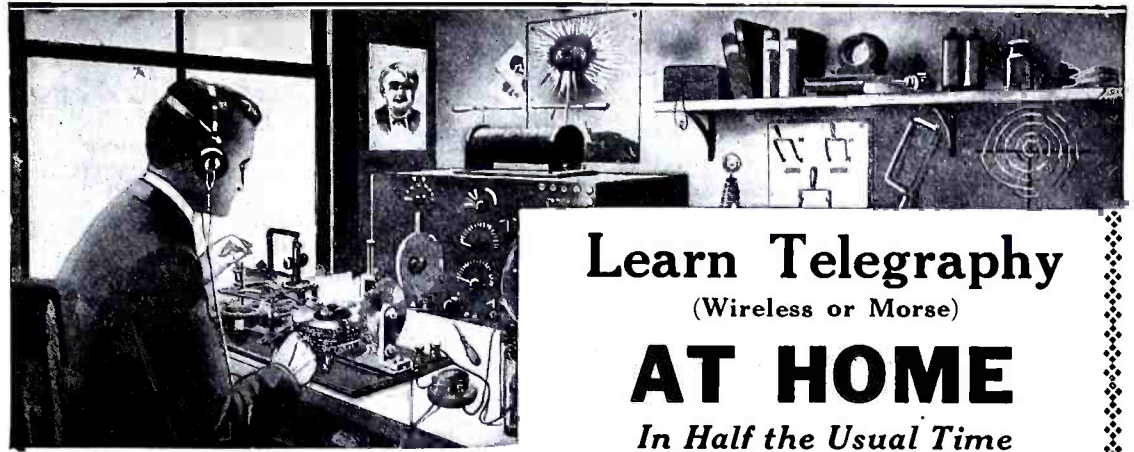

## Learn Telegraphy

(Wireless or Morse)

# AT HOME

In Half the Usual Time

## Let the OMNIGRAPH Teach You Wireless

"Just Listen—The Omnigraph will do the teaching"

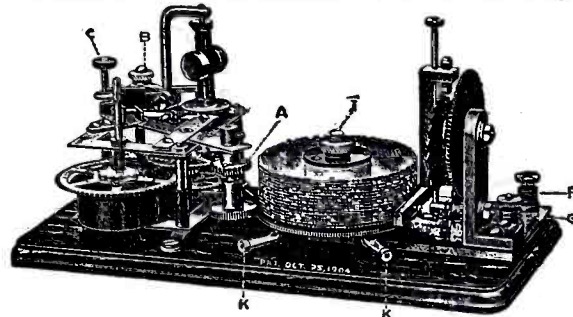

Write for Free Catalogue

For a few dollars you can have a complete outfit that will make you an experienced operator in the shortest possible time. No hard, laborious work—just learn by listening. The omnigraph is adjustable so you can start receiving messages slowly, gradually increasing the speed as you become proficient.

You'll be surprised how quickly you will attain speed. Even if you are already an operator the Omnigraph will help you. It will make you more proficient, more accurate and more confident. Thousands of Omnigraphs are in use today and thousands of operators owe their success to them.

The Omnigraph is an *Automatic Transmitter* that teaches you both the Wireless and Morse Codes, at home, without any expense except the cost of the machine itself. Merely connect to battery and your Buzzer, or Buzzer and Head Phones, or to your Sounder and the Omnigraph will send unlimited messages by the hour, at any speed you desire.

USED BY THE U. S. GOVERNMENT

The Omnigraph Mfg. Co., 26-H Cortlandt St. N.Y.

Gentlemen:—

As per your ad in Radio News please mail me your free catalog of Omnigraphs.

Name.....

Address.....

City..... State.....

## The Omnigraph Mfg. Co.

26-H Cortlandt St.

New York City

# "ILLINOIS" THE RELIABLE MADE RIGHT - STAYS RIGHT



STYLE No. 1



STYLE No. 2

Three Styles: No. 1, Panel; No. 2, Open Type as shown; No. 3, Fully Encased. Anti Profiteer. Less than pre-war prices. Fully assembled and tested.

	Style No. 1	Style No. 2	Style No. 3
67 Plates,	\$7.00	\$8.00	\$8.50
43 "	3.50	4.50	4.75
23 "	2.75	3.75	4.00
13 "	2.25	3.25	3.50

Money back if not satisfied. Just return condenser within 10 days by insured Parcel Post.

Options:— With Style No. 1—instead of Scale

and Pointer, a 3-inch Metal Dial at 50 cents extra, or a 3-inch Bakelite Dial at \$1.00 extra. Large Knobs. Both excellent values. Or we will, if desired, supply the Condenser with smooth 3-16 inch center staff, without Scale, Knob and Pointer, at 15 cents off the list to those who prefer to supply their own dial.

Vernier with single movable plate applied to 13, 23 or 43 plate condenser, \$3.00 extra.

We allow no discounts except 5 percent on orders of 6 or more.

Sent Prepaid on Receipt of Price

Except: Pacific States, Alaska, Hawaii, Philippines and Canal Zone, add 10c. Canada add 25c.

Foreign Orders other than Canada not solicited.

G. F. JOHNSON, 625 Black Ave., Springfield, Illinois.

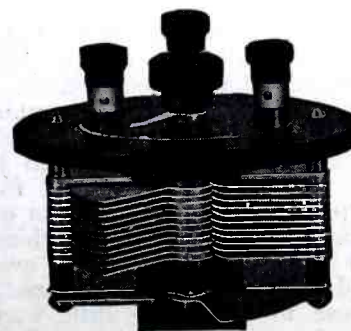

VERNIER



# OPPORTUNITY AD-LETS

Follow these advertisements every month. Reliable advertisers from all over the country offer you their most attractive specials in these columns.

Classified advertising rate six cents a word for each insertion. Ten per cent discount for 6 issues, 20 per cent discount for 12 issues. Name and address must be included at the above rate. Cash should accompany all classified advertisements unless placed by an accredited advertising agency. No advertisement for less than 10 words accepted.

Objectionable or misleading advertisements not accepted. Advertisements for the December issue must reach us not later than November 10.

## THE CIRCULATION OF RADIO NEWS IS OVER 42,000

EXPERIMENTER PUBLISHING CO. INC., 233 and 236 Fulton Street, New York, N. Y.

### Aeronautics.

**Unbreakable Model Aeroplanes** fly 600 feet, \$1.25 post-paid. Wanted Mignon RW 3. H. W. Turner, c/o Marconi Company, Montreal, P. Q.

### Agents Wanted.

**Agents Coining Money** selling Universal Gas Savers for every gas stove. Wonderful device. Cuts gas bills in half. Increases heat. Popular prices. 100% profit. Exclusive territory. Write quick. B. E. Moore, Gas Saver Company, Topeka, Kansas.

**Big Money, Quick Sales, Fine Profits** and steady demand selling Clows-Knit guaranteed hosiery direct from mill to wearers. All styles for men, women, children. Many making \$3000 year. George Clows Company, Desk 57, Philadelphia.

**Big Money** and fast sales. Every owner buys gold initials for his auto. You charge \$1.50; make \$1.35. Ten orders daily easy. Write for particulars and free samples. American Monogram Co., Dept. 133, East Orange, N. J.

### Automobiles.

**Automobile Owners, Garages, Mechanics, Repairmen,** send for free copy of our current issue. It contains helpful, instructive information on overhauling, ignition troubles, wiring, carburetors, storage batteries, etc. Over 120 pages, illustrated. Send for free copy today. Automobile Digest, 528 Butler Bldg., Cincinnati.

### Automobile Accessories.

**56 Miles Per Gallon** made with new patented gasoline Vaporizer. Write for particulars. Vaporizer Co., Pukwana, South Dakota.

### Motorcycles—Bicycles.

**Don't Buy** a bicycle motor attachment until you get our catalog and prices. Shaw Mfg. Co., Dept. 1610 Galesburg, Kans.

### Books.

**Concordia Magazine, Quarterly,** 9 Water, York, Penna., prints essays, stories, current events, poetry, formulas and plans. Send \$1 for three-year subscription. Sample copy 10c.

**We Buy and Sell** back issues of Radio Amateur News and Electrical Experimenter. Boston Magazine Exchange, 109 Mountfort St., Boston, Mass.

**"Amateur Licenses, and How to Get Them,"** Answers every question you could ask about amateur licenses, and prepares you for examination. Postpaid 15 cts. Philadelphia Radio Supply, 5714 Hazel Ave., Philadelphia.

### Business Opportunities.

**Substantial Manufacturing Corporation** wants capable men to establish branch and manage salesmen; \$300 upward necessary. Will allow expenses to Baltimore as explained. Address secretary, 343 St. Paul Place, Baltimore, Md.

### Chemistry

**Test Tubes.**—6 in., dozen, 30c. Bulletin free. Chemo Scientific Company, 680 49th St., Milwaukee, Wis.

**Learn Chemistry at Home.**—Dr. T. O'Connor Sloane, noted educator and scientific authority will teach you. Our home study correspondence course fits you to take a position as chemist. See our page ad on page 278 of this issue. Chemical Institute of New York, 140 Liberty Street, New York City.

### Correspondence Courses.

**Dollars Saved.**—Used correspondence courses of all kinds sold, rented and exchanged. List free. (Courses bought.) Lee Mountain, Pisgah, Alabama.

### Health.

**Tobacco or Snuff Habit Cured** or no pay; \$1 if cured. Remedy sent on trial. Superba Co., SB, Baltimore, Md.

**Pyorrhea (Rigg's disease—bleeding or swollen gums)**—hundreds have been helped by "Pyorident" the successful home pyorrhea treatment. Purifying, healing, preventative. Full month's treatment, consisting of a very beneficial massage paste and an antiseptic tooth-cleansing paste to be used in place of your ordinary dentifrice, together with full directions for treatment, \$1 postpaid. Or write for free booklet "R." Pyorident Mfg. Co., 439 Seventh St., Brooklyn, N. Y.

### Exchange.

**Sell-Swap.**—150 Stamps, mounted in looseleaf book, \$12; Arnold detector, audiotron, "B", \$15; 43 plate Murdock variable, \$3. Want unit panels, honeycombs. Perkins, 365 Union St., Jersey City, N. J.

**Bargain.**—2500 meter, crystal receiver complete including new Murdock phones, \$12. Ralph Leffler, Tiffin, O.

### (Exchange continued)

**Sell.**—Receiving set two stage amplifier, other articles. Winkler, 1314 First Ave., N. Y.

**Trade for Transmitting Apparatus.** New Colt Automatic 11 shot pistol worth \$42.50 or sell for \$18. Theodore Breyer, New Phila., Ohio.

**For Sale.**—Will sell outright for best offer. Pat. 1,274,380. Socket Transformer. A detachable voltage reducing device for electric light sockets. Address L. F. Brislin, 506 E. Win. Ave., Ashland, Ky.

**Radio Apparatus for Sale.**—Write Loren Covey, 902 S. Lincoln, Urbana, Illinois.

**Memorize Continental Code** in one hour. Qualify quickly for amateur license. See our ad on page 354 this issue. C. K. Dodge.

**DeForest.**—Type P-300, \$36; Type P-200, \$28; Type DB-100, \$6. Short Wave variometer regenerator, \$30. Perfect condition. Charles Ettl, Leonta, N. J.

**For Sale.**—15 dial omnigraph with buzzer and key. First money order for \$15 (Fifteen Dollars) takes it. Norris Glasoe, Northfield, Minn.

**Real Bargain.**—Grebe \$210 five hundred-twenty thousand meter receiver. Nothing better made. Good as new. \$120. P. A. Hardaway, Box 208, Pawtucket, R. I.

**Sell.**—Single dial omnigraph with 8 dials, \$6; Chelsea Oscillator, \$2; Pada rheostat, \$1; Mesco crystal detector, \$2; 5000 ohm B-battery resistance, 75c; key, \$1; gap, 50c; 2 Radisco 750 coils, each \$1; Mesco 6-volt rotary motor, \$5; Murdock O. T., \$3.50; 3 sections Murdock each \$2; 1/2 K.W. coil, \$5. Wm. Jepson, 278 New York Ave., Brooklyn, N. Y.

**Bargains.**—Re-entering college. 1/2 K.W. transmitting outfit. Receiving equipment, tools, Kodak material, coins, stamps. Miscellaneous. Howorth, University, Mississippi.

**Unusual Buy.**—200-20,000 meter receiver complete. High grade tuner control, bulb, phones Perfect shape. Seventy-five dollars. Box 1504, Providence, R. I.

**Trade.**—10 W. C.W. for spark. Daryl McClung, 1221 9th Ave., Huntington, W. Va.

**For Sale.**—1 K.W. condenser, non-synchronous gap, 1200 ft. 7/22 bronze antenna wire, several 1/2 H.P. induction motors. Clapp-Eastham wavemeter. Harry Weber, 1113 Walnut St., Dover, Ohio.

**Bargain.**—Don't pass this up. Paragon, \$20, not home made. Gail Wade, 1308 Hamilton St., Manitowoc, Wis.

**For Sale.**—Cabinet receiving set, panel is bakelite 12 x 18, honeycomb long and regenerative short wave set with change over switches. \$50. Kenneth Wright, Corydon, Iowa.

**For Sale.**—Regenerative receiver, \$16.50; coupler, \$4.50. L. G. Wise, 308 N. Shaffer St., Springfield, Ohio.

**Exchange.**—Complete I.C.S. advertising course (4 bound volumes) also 133 cycle, 10 inch electric fan for wireless receiving apparatus. John Bingham, 15 Riverdale Ave., Toronto, Canada.

**Sell.**—2 H.P. gasoline engine, good condition. Price, \$20. John Burke, Geldard St., Valley Falls, R. I.

**Will Trade New Set Hawkins Guides** for paid used Baldwin type C fones. William Braverman, Redding, California.

**If You Need** complete one kilowatt spark transmitter I have bargain for you. All inquiries answered. Clarence Carpenter, Champlain Avenue, Whitehall, N. Y.

**For Sale.**—5 dial omnigraph with ten dials, excellent condition, \$15. Harlie Stott, 153 E. 86th St., New York.

**Trade.**—Have Smith & Wesson police model revolver, cal. 38. Brand new. Want detector two-step cabinet. E. H. Reeves, 1237 E. 100th St., Cleveland, Ohio.

**Special Overstock Sale.**—New guaranteed materials, 3" genuine Bakelite dials, 35c; amplifying transformers, \$3; filament ammeters, \$3; voltmeters, \$4; milliammeters, \$4; twelve point variable grid leaks, \$1.25. Also few special bargains new display instruments. Quality Radio Shop, Box 126, Richmond, Indiana.

**Sell Quick.**—New Vocaloid, \$18; Filter chokes, \$3.50; Murdock variable condenser, \$3; Arme type filament transformer, \$8; modulation transformer, \$3.50; amplifying transformer, \$3.50. W. H. Schultz, 1125 North B St., Richmond, Indiana.

**Western Electric Apparatus Cheap.**—Three 4400 ohm fones, \$8 each; two loud speakers, \$20 each; four VT-1's, \$5 each; six VT-2's \$7 each. Everything new. Send your money order early. P. J. Stockwell, Box 53, West Medford, Massachusetts.

**Set of variometers.**—Cost new \$18, sell same as new, \$13; Marconi VT2, used ten hours, \$6. Joseph Smith, 1290 Belvidere Ave., Detroit, Michigan.

**For Sale.**—One P100 DeForest receiver and audion detector complete with bulb, B battery and three coils almost new, \$40. Claude Simpson, Lawton, Okla.

**Exchange.**—New type variometer regenerative cabinet, with tube control for motorcycle. Edwin Stowe, 13 Silk St., Chelsea, Mass.

**For Sale.**—Regenerative receiver with detector unit, \$40; 2 Amrad crystal receivers, \$15 each; Amrad variometer, \$10. Frank Sandulli, 345 B'way, So. Boston, Mass.

**For Sale.**—Wireless set coupler Murdock phone, etc.—new, \$12; Lineman's telephone, complete, \$8. Biely Thorn, Loreley, Md.

**Sale or Trade.**—Several good rebuilt storage batteries, \$7 to \$10. Guaranteed. Standard apparatus only considered in trade. P. C. Smith, Box 237, Seymour, Indiana.

### (Exchange continued)

**R A—6 Type Receiver,** twenty-five dollars; audion panel, four dollars; Rhamstine amplifying transformer, new, three dollars. Francis Bethell, Upper Montclair, New Jersey.

**Amateurs.**—Rotary gap motor, \$6; Packard 1/2 K.W. transformer, \$9; 2 Murdock transmitting condensers at \$2 each. F. W. Caitland, 243 Maple Ave., Edgewood, Pennsylvania.

**Grebe Special,** \$50.—Or trade for Westinghouse regenerative. Ray Schlegel, 1118 N. Negley Ave., Pittsburgh, Pa.

**Bargain.**—Nearly new, Duck's 1-inch spark coil, \$5.50; transmitting condenser, \$1.25; zinc spark gap, 75c; No. M560, parts for helix, assembled, \$2.50. All apparatus in fine condition. Will sell all for \$9.50. Robert Shelby, 1114 W. 9th St., Austin, Tex.

**Miscellaneous apparatus** for sale or trade; two mercury rectifier tubes; two six volt generators; one 220-volt generator; three transformers; variable condensers; Benwood discs; one heavy O.T.; one G.E. induction motor, etc. Write for complete list. B. C. Smith, Box 237, Seymour, Indiana.

**For Sale.**—Complete receiving set composed of Arnold coupler, Murdock phones, Crystal detectors, etc. Excellent condition. Thirty dollars. L. R. Warner, East Greenbush, N. Y.

**For Sale.**—One K.W. 500 cycle generator and transformer, new, \$80; also 600 ft. of navy standard antenna wire, \$10. H. M. Warner, Great Notch, N. J.

**For Sale.**—Amplifon AG N-1, Seals Unbroken, \$45; Grebe CR-2 short wave regenerative receiver, new, \$45; Cast iron housing (Cambridge semi-quenched rotary. Just the thing for a Benwood, \$6; Clapp-Eastham change over switch, \$7; 3/8 inch copper tubing, 25c; foot lighting switch, \$2. That Lab at Baton Rouge, La., 645 Mills Ave.

**Sell.**—At reasonable prices, wireless instruments of all descriptions; motors, generators, batteries, transformers, meters, wire, and an assortment of electrical instruments. For general information phone A. Link, Juniper, 2584 or call personally at C. Unverzagt, 1417 N. Kildare Ave., Chicago, Ill.

**Tresco BS Tuner,** \$8. Write for list of bargains. B. W. Casselberry, 620 Plumus St., Reno, Nevada.

**For Sale.**—6 DeForest unit panels, also regenerative set. Merrill Wenner, 3106 Midvale Ave., Phila., Pa.

**Sell or Trade** Mignon R. C. 2, cabinet tuner, \$15. S. Andrews, 2504 W. 7th St., Cleveland, O.

**For Sale.**—Grebe variometer, two variometers, detector panel, radiotron tube, no batteries, A-1 condition, \$28. Also complete set Hawkins Guides, \$6. Buehrer, 260 St. Nicholas Ave., Brooklyn.

**For Sale.**—Amrad quenched gap 1 K.W., \$27.50; 1/2 K.W. oscillation transformer, \$3.25; 3500 meter loose coupler, \$7.75; Meteor key, \$5; Standard key, \$3.50. Lawton Biddle, 442 Bosart Avenue, Indianapolis, Indiana.

**600-20,000 Meter Receiving Cabinet** including audions, \$35. Murdock variable, \$2.50. Wireless magazines cheap. Box 205, Williamsport, Pa.

**For Sale.**—Complete receiving equipment and accessories. Write R. Ekholm, 17 Orchardfield St., Dorchester, Mass.

**Sell or Swap.**—Van Dorn Electric Drill, used short time. Would consider Det and 2 step. For particulars write. Carl Cardin, Cushing, Okla.

**Swap.**—15,000 meter loose coupler and loud speaker receiver for storage battery and audion, 6 volt motor for .0005 variable. Jack LeFerre, 714 S. 20th St., LaFayette, Indiana.

**Trade or Sell.**—Yale motorcycle, sidecar with new tire, 4 bicycle frames, Stewart speedometer, 3000 meter loose coupler, 7 jewel gold Waltham, Daisy pumpgun. Want complete 2 step amplifier, regenerator. Howard Gould, Alfred, N. Y.

**Selling Out.**—Install for Winter season—new 1/2 K.W. Thordarson transformer, \$25. Rotary gap with Hamilton Beach motor, \$10; oil immersion condenser for transformer in tank, \$5; oscillation transformer, \$3. Complete set \$40, regenerative tuner on panel, two radisco variometers and one radisco coupler, \$25. Charles Harrison, Chestnut Ridge, Lockport, N. Y.

**Sacrifice.**—New and guaranteed two filament audiotrons, \$4. Hudson City Radio Shop, 89-91 Franklin St., Jersey City, N. J.

**What Am I Offered** for a 1/2 kilowatt panel transmitting set? H. M. Hall, 1731 Winna St., Chicago, Ill.

**For Sale.**—Grebe Type Rorh, vacuum tube control unit, \$12. Never used. Gerald R. Harbin, Manistique, Michigan.

**Trade.**—Nearly new 3 1/2 x 4 1/4 Auto Graflex, Velostigmat lens, plate-holder, film-pack adapter, developing tank and complete outfit in perfect condition for good C.W. receiving set. No junk, but might pay cash difference if your stuff is worth it. F. V. B., 447 Division Ave. S., Grand Rapids, Mich.

**Bargain.**—DeForest P-500 new bulb and batteries, \$18. Brandes superiors, \$4.50. Kenneth Dixon, Colorado Springs, Colo., M.R.S.

**Sacrifice.**—Detector two step amplifier, complete, "B" Batteries, bulbs, etc., \$65. A. J. Ellsworth, Fowlerville, Mich.

**For Sale.**—Complete 1/2 K.W. spark set, 1 K.W. Amrad quenched gap, and Grebe RORH. A-1 condition. Noel Olmstead, Concordia, Kansas.

**Wanted.**—1/2 K.W. sending cond. Helix, and gap, or what have you? All letters answered. E. H. Maack, Kimball, S. D.



(Exchange continued)

**Selling Out Cheap.**—Wireless receiving instruments. Write Neal Mitchell, Mason St., Beverly, Mass.

**Battery.**—4-40, \$8; 25 plate DeForest condenser, \$4.25; L25, L35, L50 Honeycombs, \$2.75. J. Lindauer, 8 Park St. Jersey City.

**For Sale.**—Radio phone transmitter complete with tubes and motor generator. F. W. Lehr, 218 College Place, Norfolk, Va.

**Omnigraph,** number five, with fifteen dials, seven dollars. Universal tuner, 3500 meters, five dollars. J. R. Lynch, 690 West 112th St., New York City.

**For Sale.**—All kinds of radio apparatus, write for particulars. Henry Nalbach, Moweaqua, Ill.

**V.T. Control,** complete with bulb and "B" Battery, \$15. Short wave regenerative receiver, \$30. Other bargains. Price list on request. C. C. Perkins, Sangerville, Me.

**For Sale.**—Radio and radiofone course complete with automatic transmitter, fifty dollars. John Pavo, 463 Underwood St., Fall River, Mass.

**For Sale.**—Loose coupler Duck's 5 BB, \$16; two Clapp-Eastham variometers, \$11.50; two Murdock variable condensers, \$6.60, \$6.50; one Murdock fixed condenser, 75c; three Murdock sockets, \$2.25. All practically new. Harold E. Peck, 62 Governor St., Providence, R. I.

**For Sale.**—1/4 K.W. transformer, \$6. Detector panel, regenerative receiver and parts. 9 AVO, 746 So. Armstrong, Kokomo, Indiana.

**For Sale.**—Willard eleven plate battery. Used very little. Only \$15. Luther McGinty, Elberton, Ga.

**Bargain.**—Three Grebe units, receiver, two step and detector, Ninety Dollars, or separate. F. B. Meeker, 52 Elliott Ave., Yonkers, N. Y.

**Long Wave Set,** \$16.50. Short wave with audion control combined, \$18. Gordon Rideout, Linden St., Everett, Mass.

**For Sale.**—Honeycomb tuner with coils, detector, two-step amplifier all in cabinet 26" x 13", price \$70. Complete disc and photo, 5 cents. H. Peacock, Barker, N. Y.

**Omnigraph No. 5,** \$5; two filament audiotron, \$4; adapter, \$1; Superior key, \$1.50; 1500 meter loading coil, \$1; Murdock .001 variable in case, \$3.75; Postcard size Premo special lens, \$18. H. W. Ritter, Tippicanoe City, Ohio.

**Sacophone.**—Straight model soprano, brass, fitted with new pads and mouthpiece. Will exchange for Magnavox or other radio equipment. R. P. Ruddy, 542 Maple Ave., Cincinnati.

**Must Sell.**—2500 meter loose coupler, \$5.50; audiotron, both filaments good, \$5; 5 dial Omnigraph, new, \$18; Murdock 23 plate variable, new, \$3.50; Century buzzer, \$1.75. Chester Park, Mountain View, Missouri.

**Bargain.**—Complete five thousand meter crystal set, Eighteen Dollars; audion panel, five-fifty. Write Radio, 1015 E. Columbia Ave., Phila., Pa.

**Complete Receiving Panel,** containing 3000 meter loose coupler, 600 meter variocoupler, two condensers, potentiometer, galena. Surprisingly efficient. Photo, full details upon request. Bargain, \$35. Spark coil, 1 1/2" new, \$8. Wilfred Rausenberger, River Edge, N. J.

Electrical Supplies and Appliances.

**Did Your Battery ever run down without you knowing it?** It won't happen if you get one of our battery hydrometers. 70 cents each postpaid. Sterling Radio Equipment Co., 2723 Cooper Ave., Brooklyn, N. Y.

**Supplies and Materials,** all kinds, electrical, mechanical, also books, we furnish what you need. Tell us your wants. We give you price and quick delivery. No catalogue. Steffy Mfg. Co., Electrical Dept., 5025 Brown St., Phila., Pa.

**Ironclad Exide Storage Batteries,** Type MV-9 plate, 140 ampere hour capacity, in sealed rubber jars, assembled in four cell trays, or sold singly, for \$15 a cell F.O.B., New York. First class condition, never used. V. C. Wagner, Summit, New Jersey.

**Blueprints.**—Electrical connecting diagrams. Samples, 20c. Catalog free. Charles Chittenden, N3024 Matthews, Kansas City, Missouri.

Formulas.

**Amateurs and Experimenters** Silver plating without a battery, cyanide or other objectionable ingredients. Make money playing radio instruments, etc., or manufacture and sell the compound. Two formulas, \$1. Jos. Fezekas, 430 Prescott St., St. Paul, Minn.

For Men.

**Hand Made Razors,** \$1.98. 15 days' trial. Send no money. A. E. Schwemler, 748 Parkwood, Cleveland, Ohio.

For Advertisers.

**Don't Wait for Business.**—Advertise and get it. We will help you. Jacobus Service, 41 Bruen, Irvington, N. J.

For Inventors.

**Inventors Test Your Idea** before getting that patent. Write P. Fonos, New Richmond, Wis.

Help Wanted.

**Wanted.**—Live boys to sell regenerative sets. Big money. Jno. Sensenig, Jr., New Holland, Pa.

**Earn \$25 Weekly,** spare time, writing for newspapers, magazines. Experience unnecessary; details free. Press Syndicate, 5665, St. Louis, Mo.

**Detectives Earn Big Money.** Excellent opportunity. Travel. Great demand everywhere. Fascinating work. Experience unnecessary. Particulars free. Write, American Detective System, 1968 Broadway, New York.

**Be a Mirror Expert,** \$3-\$10 a day; spare time home at first; no capital; we train, start you making and silvering mirrors, French method. Free prospectus. W. R. Derr, Pres., 579 Decatur St., Brooklyn, N. Y.

Novelties.

**Genuine Indian Baskets.** Wholesale catalogue. Marion Gilhams, Kelseyville, Calif.

Instruction.

**Learn Chemistry at Home.**—Dr. T. O'Connor Sloane, noted educator and scientific authority, will teach you. Our home study correspondence course fits you to take a position as chemist. See our full page ad on page 276 of this issue. Chemical Institute of New York, 140 Liberty Street, New York City.

**Watchmakers.**—Send for most practical information on adjusting watches. Walter Kleinlein, Waltham, Mass.

**Play Mouth-Organ.**—Complete, easy instructor, 25c. Elsea Co., Bowling Green, Ohio.

Manufacturing

**Small Induction Motor** punchings and castings. Robert Vondrau, Preston, Ont., Can.

Miscellaneous.

**Preserve Your Call Book.**—Binders for Consolidated Call Book. Black cloth binding, stiff covers, gold stamped. Easy to insert book. Binder can be used again for new editions. 60c money order brings your binder. Louis Prudon, West Hoboken, N. J.

**Protect Tools With Your Signature.** Solution eats hardened steel. Formula, 25c. Instructions 10c. George McBeth, Bucyrus, Ohio.

**One-Armed Men Play Cards!** I shuffle, deal and hold cards with one hand with my own invention. Highly finished, artistically designed machine. Weight 1 lb. Size, 6" x 8". No cogs or springs. Simple to operate. \$5. Postage Paid. Victory Card Playing Machine Co., 1148 Hancock St., Brooklyn, N. Y.

**Artifical Marble.** sanitary flooring instructions, ornamental casting, concrete plaster, papier-mache decoration, garden furniture, statuary. Rubber-moulds, electro-metallurgy, particulars and 200 illustrations free. C. Mahler, Box 122 Huntington, N. Y.

**At Stud Airedale Vagabond.** Ideal, \$25. Other varieties for sale. Circular, 10c. Shadydell Kennels, York, Pennsylvania.

News Correspondents

**Earn \$25 Weekly,** spare time, writing for newspapers, magazines. Experience unnecessary; details free. Press Syndicate, 566 St. Louis, Mo.

Office Devices

**Multigraphs, Typewriters, Addressing Machines.** Duplicators, Folders, Sealers, Check Writers, Dictaphones, Office Equipment. Bought, sold, exchanged, rebuilt. Pruitt Company, 110 North LaSalle, Chicago.

Personal.

**Astrology.**—Stars tell Life's Story. Send birthdate and time for trial reading. Eddy, Westport St., 33-30 Kansas City, Missouri.

Patent Attorneys.

**Patents.**—Send for free book. Contains valuable information for inventors. Send sketch of your invention for free opinion of its patentable nature. Prompt service, twenty years' experience. Talbert & Talbert, 440 Talbert Bldg., Washington, D. C.

**Millions Spent Annually for Ideas.** Hundreds now wanted! Patent yours and profit! Write today for free books—tell how to protect yourself, how to invent, ideas wanted, how we help you sell, etc., 301 Patent Dept., American Industries, Inc., Washington, D. C.

**E. T. Brandenburg** (former patent expert, Ordnance Division, War Department). Attorney-at-law and Solicitor of Patents, 927 Loan and Trust Bldg., Washington, D. C. Send sketch and description, or model of your invention for careful investigation at Patent Office and unbiased report as to patentability.

Photo Developing.

**Get Acquainted Offer.**—Mail us 20c with any size film or six negatives for development and six velvet prints. Twenty-four hour service. Fine work. Roanoke Photo Finishing Co., 324 Bell Ave., Roanoke, Va.

Printing.

**Printing.**—The Better Kind. May we quote on your next printing order? Olde Tye Press, 328 Richards Ave., Dover, N. J.

**Everything Printed.**—Long run specialists. Samples. Quality Printery, Marietta, Ohio.

**250 Letterheads,** and 250 envelopes for \$2.75. Write for price list and samples. Balkow Printing Co., Meriden, Conn.

**Labels,** 60c per 1,000 up. Irvin J. Wolf, Station E, Philadelphia.

Scenery for Hire.

**Settings for all operas and plays.** Catalog. Amelia Grain, Philadelphia.

Song Writers.

**Song Writers!**—Learn of the public's demand for songs suitable for dancing and the opportunities greatly changed conditions offer new writers, obtainable only in our "Song Writers' Manual and Guide," sent free. Submit your ideas for songs at once for free criticism and advice. We revise poems, compose music, secure copyright and facilitate free publication or outright sale of songs. Knickerbocker Studios, 319 Gaiety Bldg., New York.

Stammering.

**Stammerers.**—You can be permanently cured by my course of private individual lessons. Interesting booklet free. Samuel I. Robbins, 246 Huntington Avenue, Boston.

Stamps and Coins.

**1000 Different Stamps,** \$3; 500, \$1.25; 200, 25c; 100, 12c. Approvals. Michaels, 5602 Prairie, Chicago.

**Three Old Coins,** 10c; coins, cameras, shotguns, etc. bought. Chas. Dursc, Dept. 50, 25 Mulberry, N. Y. City.

**Approvals 70% Disc.** Wells, 3730 Fruitvale Ave., Oakland, Cal.

**Free.**—Menagere. Packet to Approval Applicants, Reference. Liberty, 3974 Arsenal, St. Louis, Mo.

Telegraphy.

**Telegraphy**—(Morse and Wireless) and Railway Accounting taught thoroughly. Big salaries. Great opportunities. Oldest, largest school. All expenses low—can earn large part. Catalog free. Dodge's Institute, 41 St., Valparaiso, Indiana.

Wireless.

**Regenerative Coils and Hook-up.**—Amateur, commercial, time. Any three-coil set, \$2. Three sets complete, \$5. Theodore Cutting, Campbell, California.

**Ten Sections Murdock Transmitting Condenser;** oscillation transformer; enclosed rotary gap; variable speed motor; panel transmitter; variable grid leak; vibroplex key; eight pounds 32 wire; complete radiophone and CW set; 220 volt synchronous motor. Write for particulars. Crowlus, 5047 Washington Ave., St. Louis, Mo.

**Short Wave Regenerative Sets** with dials for sale, \$25. Guaranteed. Robert Emery, Grove City, Pa.

**\$3 Brings You a Roller-Smith Panel** type hot-wire Ammeter, new, tested, and in perfect condition. Regular price \$13. Range, 0-2.5 Amp. Ideal for small C.W. transmitters. Unusual opportunity. Sent prepaid or parcel post C.O.D. for \$3. Beiter act today as the quantity is limited. C. J. Goette, 21U, 1624 Hamilton Ave., Woodhaven, N. Y.

**Western Electric V.T. 1.s,** \$8; V.T. 2.s, \$12; Baldwin phones, \$10; regenerative receiver, \$28, variocoupler, \$3.75; variometers, \$4.25; detector, 2 step, \$45; amplifying transformers, \$3.50; Radisco coils at cost. Send stamp for list. Haas, 2011 Atlantic Ave., Atlantic City, N. J.

**500 Volt Motor Generator Set.** 500 volt Holtzer Cabot generator direct connected to 1/4 H.P. General Electric 110 volt alternating current motor, mounted on heavy cast iron base, \$65; 1/4 H.P. Sprague Electric 500 volt series wound motor, \$20; 10 volt 8 amp. Holtzer Cabot direct current generator, \$16; 1/30 H.P. General Electric 110 volt induction motor, speed 1800, \$7; 110 volt Dicht direct current fan motor, \$5. Enclose stamp for reply. All these will be shipped express collect. E. Hubner, 1607 McKee Street, Houston, Texas.

**Attention Amateurs.**—Hear POZ, FL, LY, and radiophone concerts with single audiotron bulb. We sell blueprints of design, wiring and instructions for building panel that will accomplish this, \$0.50. 8" x 9" blueprint of wireless code, \$0.25. Money orders preferred. Promptness guaranteed. Radio Blueprint Co., Lock Box 73, Shepherdstown, West Virginia.

**Wireless Men of the 3d District.**—It will pay you to get RA-Cond prices and service before all others, compare this list of Guaranteed Apparatus—Variometers, \$5; Variocouplers, \$4.75; short-wave regenerators, \$33; audion controls, \$6; fleish oak cabinets, specially made any size on short order, stock sizes, 16 x 8 panel, \$3; 10 x 5 panel, \$2.50, made from 1/2 quartered oak, solid construction. Special turned parts, brass and wood done for experimenters special apparatus constructed from your own parts. We carry standard apparatus in stock, specialists in all types of receiving and transmitting valves, at amazing prices all guaranteed. Our RA-Cond Nichrome Rheostats lead all others for Power Valves, Licensed under the Marsh Patents, for panel mounting, \$1.25 each, open daily from 10 A. M. to 10 P. M. The Radio Equipment Company, 1525 N. Fawn Street, Philadelphia, Pa.

**Amateurs.**—Send dime for set of 3 radio signs. 5 for 15c. Service Printing Co., Sharpville, Pa.

**Cunningham Tubes** at reduced prices, detectors, \$4.30; amplifiers, \$5.20; have a few left. First come first served. E. Hubner, 1607 McKee Street, Houston, Texas.

**New Synchronous Motors,** \$27.50.—1/5 H.P., 220 volt, 1800 R.P.M. Also 1/4 and 1/2 H.P., 110 and 220 volt synchronous motors at very low prices. Stock limited—order at once. Stahl Rectifier Company, 1405 W. Jackson Blvd., Chicago, Ill.

**Unit Receiving Inductances** assure satisfactory, efficient, and unparalleled long distance reception of all forms of radio transmission. For long wave work our Bi-Lattice coils (Duo-lateral) need no introduction. For short wave reception a set of single layer coils compares favorably with the best regeneratives; and the cost is but a fraction of the regular regenerative receiver. Send 3c for bulletin. Our prices and service will surprise you. P. J. Stockwell, Box 157-C, Reading, Massachusetts.

**Short Wave Regenerative Set.**—Splendid new \$45 set sell quick, \$30. New detector panel set. Ammeter, variable condenser, voltmeter, choke coils, crystal set, 1/2" induction coil, tuning coil, buzzer, fixed mica condensers. C. O. Snyder, National Ave., Richmond, Indiana.

**Audion Renewals.**—Any type of detector, renewed for \$2.75; any type of amplifier, for reception, \$3 only single stem tubes, no tubular audiotrons accepted. 10 years' experience guarantees results, all tubes tested on our wireless before shipment. Cash with order makes for quick results. Trimount Laboratory, Milford, Mass.

**Hawaiian and German stations** read with a single bulb. Are you satisfied with your receiving set? Would you like to build one that will receive over 6000 miles on a single bulb and quit experimenting? One that will be the equal of any regardless of claims or price. Using the instruments you now have, you will be able to duplicate the long distance records you read about every day. Get our simple diagram of a complete short and long wave receiver, 175 to 20,000 meters, with which we read Honolulu, California, German, South American, French and English stations, and practically all the high powered foreign and domestic stations, amateurs as far west as New Mexico and numerous telephone and musical concerts come in good. Diagram and complete instructions, leaving nothing to guess about, will be promptly mailed for 50 cents in coin or stamps. Wire a set up and quit wasting good money. Virginia Novelty Company, Martinsburg, West Va.

**New Rochelle,** has a radio shop. Get your Radio supplies at Sutton's Sport Shop, 57 Huguenot Street.

**Attractive Prices.**—On V.T.'s and other apparatus. George Stackpole, Exeter, New Hamp.

(Continued on page 366)



### RADIO SUPPLIES 4th DISTRICT

We have a complete line of radio apparatus of standard makes, Acme, Amrad, Chelsea, Clapp-Eastham, Eveready, Federal, General Radio, Murdock, and Radio Corporation of America.

**FORMICA PANELS**

6 x 12 x 3/16 in.....	\$1.35
6 x 18 x 3/16 in.....	2.00
9 x 12 x 3/16 in.....	2.00
12 x 18 x 3/16 in.....	3.85

**RADIOTRON TUBES**

UV-200 Detector.....	\$5.00
UV-201 Amplifier.....	6.50
UV-202 5 Watt transmitting	8.00
UV-203 50 Watt transmitting	30.00
UV-712 Amplifying Trans-	
former.....	7.00
PR-536 A. Bat Potentiometer.	2.00
677B Battery 22½ V. 5 taps..	3.00

Write for complete price list of Material Carried in Stock.

**CARTER ELECTRIC CO. RADIO DEPT.**  
63 Peachtree St. Atlanta, Ga.

Radio Amateurs of COLORADO UTAH, NEBRASKA and WYOMING

DO YOU KNOW

## DENVER

HAS THE LARGEST WIRELESS SUPPLY STORE in the MIDDLE WEST

We are Exclusive Agents for DeFOREST, REMLER and RADIO SHOP. Complete stock of MURDOCK, FIRTH, CLAPP-EASTHAM and all standard Radio Supplies, from which we make

**IMMEDIATE DELIVERY**

Write for our Bulletins and Price List. We will give prompt Mail Order Service by Parcel Post or Express, as requested.

Our "REYNARD" Short-wave Coils are best on the market—\$2 each.

**REYNOLDS RADIO CO., Inc.**  
613 19th Street, DENVER, COL.

NEW ORLEANS RADIO APPARATUS and SUPPLIES

**ROSE RADIO SUPPLY**  
604 Gravier St., New Orleans, La.  
Send 10c for Latest Catalog

## Radiograms

Message Blanks for Radio Men

**RADIOGRAMS**

Per pad of 100 sheets.....	30c
Per 10 pads (10% discount).....	\$2.70

**RELAY RADIOGRAMS**

Per pad of 100 sheets.....	30c
Per 10 pads (10% discount).....	\$3.15

No postage stamps accepted (Size 5½x8½ inches) **POSTPAID**

Attractive discounts to dealers and clubs purchasing in quantity lots.

Dept. R-1  
**American Radiogram Company**  
Room 708, 305 Broadway, New York, N. Y.

(Continued from page 365)  
(Wireless continued)

**Cabinets.**—Finished oak 6x6 ¾ x 6 deep, any quantity, \$1 each, weight 3 lbs. Bakelite panels to fit cabinets, ¼ inch thick, drilled for variometers, varcouplers, audion detectors, detector amplifiers, or two stage amplifiers. 75c each. Weight 1 lb. No blank panels. Variable condensers, heavy aluminum plates, for panel mounting, without dials, .001 Mfd., \$3.75. .0005 Mfd., \$2.75. Weight 5 lbs. All brand new stock. No C. O. D.s. Add postage. H. Butterworth, 331 Quincey St., Brooklyn, N. Y.

**Pure Hard Drawn copper strips** for oscillating transformer primary two inches wide, fifteen feet long; secondary, one inch wide twenty-three feet long. Makes the best of transformer; price per set of two, \$5 F. O. B. factory; shipments ten days direct from factory. C. S. Newcomb, Mars Hill, Maine.

**Stop! Look! and Act! V.T.'s.** With each radiotron U.V. 200 V.T. detector or A-P Moorehead V.T. detector or radiotron U.V. 201 V.T. Amp. or A-P Moorehead V.T. Amp., we will supply free of charge your choice of either a Murdock V.T. socket improved contact type or a Remler Bakelite Smooth running rheostat latest type, radiotron U.V. 200 \$5; radiotron amp. V.T. U.V. 201, \$6.50; Moorehead A-P detector, \$5; Moorehead A-P Amp. V.T., \$6.50; Remler Bakelite rheostat latest type, \$1; Murdock V.T. socket, \$1; Clapp-Eastham panel mounting rheostat of 4 ampere capacity or Murdock socket supplied free of charge with each \$8 U.V. 202, 5-Watt radiotron power tube for C.W. or radiophone transmission. We absolutely guarantee the foregoing apparatus. Only new and high grade equipment carried in stock. All orders are filled within twelve hours and shipped postpaid and insured, thereby saving time and money. Remember us. The Kehler Radio Laboratories, Dept. R, Abilene, Kansas.

**Attention Amateurs.**—Use plate glass instead of bakelite or rubber panels in your cabinet sets. Can see working parts at all times. Send design. We drill holes and finish edges. Johnston Glass & Mirror Works, 1118 Varlo St., N.S., Pittsburgh, Pa.

**Memorize Continental Code** in one hour. Qualify quickly for amateur license. See our ad on page 354 this issue. C. K. Dodge.

**Orders Filled in Twelve Hours.** The Kehler Radio Laboratories.

**Special Two in One double service plugs** makes—single sockets. Double workers. Fits any Standard socket. Regular \$1 value for 75c. Postage paid. Howard Hunt, Box 108, Macedonia, Ohio.

**Variable Condenser Parts, Plates .04c.** Washers .05c and .10c a dozen. Dime for samples. Complete line of Radio Apparatus. Gravenstede, 84 Hancock Ave., Jersey City, N. J.

**Are You Next to the prices on our detector and amplifier control panels?** If not it will be worth your time to investigate. We will have one and two step amplifiers with plug and jack control ready by November Tenth, get our prices on these. Every instrument that leaves us has been given a rigid test under actual signal conditions. Get in touch with us. Devore Radio Supply Co., Gibson City, Illinois.

**Orders Filled in Twelve Hours.** The Kehler Radio Laboratories.

**Baldwin Phones.**—Reduced prices and? Why are Baldwin's so sensitive? Briefly, because—1. The small armature is pivoted and designed to act as a fulcrum when connected to the diaphragm by a small link. There is no tension or springing of metal as in ordinary receivers. 2. Four pole pieces of a single solenoid act upon both sides of a lightly balanced armature. 3. The force is concentrated at the exact center of a sensitive mica diaphragm, (identically the same as in all high grade phonograph reproducers.) Original, type "C"—\$13.75. Improved type "E"—\$15. Lighter, type "F"—\$16.25. Single loud speaker unit, without cord type "C"—\$6.80. Without cord type "E"—\$7.50. With each pair of phones purchased, we will extend or give, free of charge, a one year's subscription to the Radio News. These well known head sets are absolutely guaranteed and subject to return in five days if not satisfactory. Postpaid, insured, twelve hour service. The Kehler Radio Laboratories, Dept. R, Abilene, Kansas.

**Get Ready for the Good Radio Weather.** Our VT circuits, each on separate blue print will enable you to try out a large range of proven hookups. Set of twelve, receiving or phone transmitting, 50c. Complete set of 24 for \$1. The Plan Bureau, 1929 McCausland Avenue, St. Louis, Mo.

**Audion Detector and Amplifier, V.T.,** 50 cents. Honeycomb coil mountings, 25 cents. Back mounted rheostats, 40 cents. Composition for molding your own knobs, panels, etc. 35c pound. Send stamp for particulars. Palmers Electrical Equipment Co., Palmers, Minn.

**Special Offer.**—For a limited time we are giving everyone a chance to buy a reliable amplifying transformer of correct design at the lowest price on the market. We are offering the Clapp-Eastham amplifying transformer which gives results second to none. (Same as illustrated in recent issues of the Radio News), list price, \$4 our price \$3.45 postpaid. Immediate delivery, subject to return if not satisfactory. The Radio Distributing Company, Dept. R, Abilene, Kansas.

**Mr. Amateur.**—Try one of our thirteen thousand R.P.M. gap motors just Fifteen Dollars. Ten point disk ¾ inch face only Four Fifty. Many other bargains. Let us help you design your station, we know how. Southern Radio Laboratory, Dublin, Texas.

**We Have Firco apparatus, Baldys, Sacoclads, etc.,** Chl-Rad variometers knockdown, \$4, set up, \$5. Get our little set. Variometer, wavemeter, receiver, and only \$9. With crystal detector, \$10. Murdock's type 56's. Write Port Arthur Radio Laboratory, 2048 Fifth Street, Port Arthur, Tex.

**Another Remarkable Stride in radio progress.** The development of a simple, efficient and inexpensive means of sending and receiving pictures, hookups, panel designs, etc., making possible the establishment of a uniform medium of picture communication throughout the entire amateur world. Our goal, 50,000 in use by Christmas. We can do it, easily, with your support. Introductory price, per complete system, 35c. Send for your system now. The Radiograf System, Box 154, Eureka, Kansas.

**Vocaloud Loud Speakers.**—Station type, \$30; Laboratory type, \$25; your choice of Saco Clad, Acme or Clapp-Eastham amplifying transformer free of charge with either type. Guaranteed. Postpaid, insured, twelve hour service. The Kehler Radio Laboratories, Dept. R, Abilene, Kansas.

The original tested crystals



Now 25c  
GALENA or SILICON

**Be Sure of Results!—Insist Upon Getting N. A. A. TESTED CRYSTALS**

These exquisitely sensitive minerals are the best that money can buy for radio detector and wave meter work. Each crystal is individually tested, wrapped in foil and packed in a convenient lithographed tin container. N. A. A. (Arlington) Tested Minerals are the original tested crystals. To avoid their many imitations, look for the signature of J. S. NEWMAN on each box. Galena or Silicon, now.

At good Radio Dealers everywhere, or shipped direct postpaid on receipt of price.....

**25c**

**THE NEWMAN-STERN CO.**  
Newman-Stern Bldg. Cleveland, Ohio

Shaft solid embedded in Knob Cannot work loose.

**45c Prepaid**



Lever 1¼" radius

Guaranteed not to work loose here either. Note the secret.

**CONTINENTAL ELECTRIC CO.**  
118 E. 129th Street  
New York, N. Y.

**Bound Volume of RADIO NEWS**

THE second year Bound Volume of RADIO NEWS Magazine is ready for shipment. Volume No. 2 contains twelve numbers, starting with July, 1920, and ending with June, 1921.

There are 936 pages, containing over two thousand articles and over three thousand illustrations, bound in red cloth, gold stamped.

With its wide variety of original articles, editorials, suggestions and drawings, this bound volume forms a valuable reference book on all questions of radio.

Send your orders at once, as we have only a very limited supply on hand.

Vol. No. 1 is sold out completely and cannot be procured any more; supply of Vol. No. 2 will not last very long; orders will be filled within 24 hours.

SEND check or money order in the amount of \$2.50 to

**EXPERIMENTER PUBLISHING CO., INC.**  
233 Fulton St., New York.

Indicate mode of transportation if parcel post, enclose charges. Sent by express collect. Weight 3 lbs.

(Continued from Preceding Column)

(Wireless continued)

**Transmit and Receive Pictures by Radio.**—Our inexpensive "Radiograf System" is being recognized by all amateurs. Expensive radio apparatus optional. One Radiograf postpaid, 35c, two 60c. The Radiograf System, Box 154, Eureka, Kansas.

**Mr. Amateur.**—We have designed an eighteen inch variometer split type no lead Oscillation Transformer you can manufacture in one day and will furnish with drawings and instructions to tune twenty-four feet of one and two-inch copper ribbon all for Five Dollars; or two and three at Six; or three and four at Seven. Guaranteed to please. Order at once. Use copper plates in your condenser. We have any size you want. Full line of radio accessories in stock. Southern Radio Laboratory, Dublin, Texas.

**Cabinets Our Specialty.**—Made to your specifications. Write for estimate. Dept. A., Star Cabinet Shop, 7th and Chestnut Sts., Lansdale, Montgomery Co., Pa.

**Wanted to Buy**

Audibility Meter, General Radio Type 122, also Arnold 2000 M. coupler. State cash price. Bizozer, 6 East 128th St., New York.



# SPECIAL 30 DAY OFFER

## Save Money—Get a FREE Premium Besides

The subscription price of Science and Invention has been \$3.00 per year. For 30 days, not only will we give you a full year's subscription (12 big numbers), for \$2.50, but we will also give you absolutely FREE, your choice of any of the well known books shown below. Read the special offers. If you want more than one book free take a two or three-year subscription. For each year you can take advantage of one offer.

If you are already a subscriber to one of our magazines, take advantage of this opportunity and send in your renewal subscription, stating what free pre-

mium you prefer; you are at liberty to send as many subscriptions or renewals as you desire, and you can pick out a free premium for each year's subscription.

You may also take subscriptions of your friends and earn the free premium for yourself.

You must act at once—Today.

These sensational offers are made by us at a tremendous sacrifice in the hope that your acceptance will make you a life-long friend of our magazines.

!! Please use order blank below! !

**The Experimenter Publishing Co., Inc.**

236 FULTON STREET, NEW YORK

### Special Free Premium Offer No. 1



#### The How and Why of Radio Apparatus

By H. W. Secor, E.E.

This newest of Radio Works has 160 pages. 6 x 9 inches.

#### OFFER No. 1

Above Book, bound in special cloth, flexible, hand sewed. FREE with a year's subscription to Science and Invention for \$2.50.

### Special Club Offer



THE 100% WIRELESS MAGAZINE

AND

## Science and Invention

Electrical Experimenter

THE UNDISPUTED AUTHORITY ON SIMPLIFIED SCIENCE AND MECHANICS

**BOTH MAGAZINES**

With any one of the FREE Premiums, as described:

**\$3.50**

- Offer 6A SCIENCE & INVENTION and RADIO NEWS with Premium 1
- Offer 6B " " with Premium 2
- Offer 6C " " with Premium 3
- Offer 6D " " with Premium 4
- Offer 6E " " with Premium

**The Biggest Clubbing Bargain Ever Offered.**

### Special Free Premium Offer No. 3

#### Wireless Course in 20 Lessons

By S. Gernsback, A. Lescarboura and H. W. Secor, E.E. (10th Edition)

Size of book is 7 x 10 1/4 in., 160 pages, 350 illustrations, 30 tables.

#### OFFER No. 3

Above Book, bound in special cloth, flexible; hand sewed. FREE with a year's subscription to Science and Invention for \$2.50.



### Special Free Premium Offer No. 2

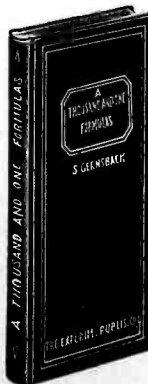

#### A Thousand and One Formulas

By S. Gernsback

It contains 160 pages. The paper has been especially selected to stand rough handling in laboratories. Size 6 x 9 inches.

#### OFFER No. 2

Above Book, bound in special cloth, flexible, hand sewed. FREE with a year's subscription to Science and Invention for \$2.50.

### Special Free Premium Offer No. 4

#### Experimental Electricity Course in 20 Lessons

By S. Gernsback and H. W. Secor, E.E.

The book contains 128 pages and more than 400 illustrations. Size of book is 6 x 9 inches.

#### OFFER No. 4

Above Book, bound in special cloth, flexible; pocket size. FREE with a year's subscription to Science and Invention for \$2.50.



### Special Free Premium Offer No. 5

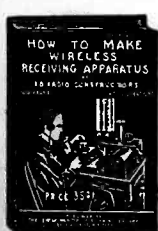

Design and Construction of Audion Amplifying Transformers Radio and Audio Frequency Type

How to Make Wireless Sending Apparatus

How to Make Wireless Receiving Apparatus

#### OFFER No. 5

Above three Books as described FREE with a Year's Subscription to Science and Invention for \$2.50.

EXPERIMENTER PUBLISHING COMPANY, Inc.  
236 Fulton Street, New York City, N. Y.

Gentlemen:

Enclosed find \$..... for which send me:

- Offer No. 1
- Offer No. 2
- Offer No. 3
- Offer No. 4
- Offer No. 5
- Offer No. 6A
- Offer No. 6B
- Offer No. 6C
- Offer No. 6D
- Offer No. 6E

MARK SQUARE ABOVE FOR ITEM WANTED.

Name .....

Address .....

Town..... State.....



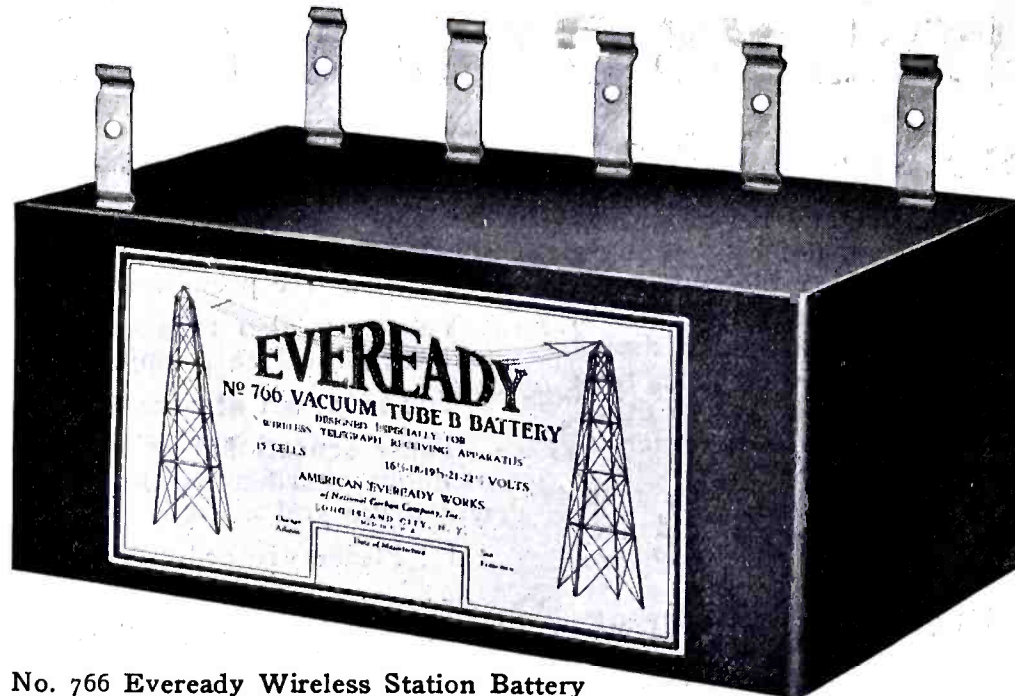

No. 766 Eveready Wireless Station Battery  
Standardized for use in U. S. Navy

## What gives the Eveready Wireless B Battery its high voltage maintenance?

**T**HE right proportioning of ingredients—the retardation of destructive chemical reactions—the control of electrolysis—the perfect insulation.

Hitch an Eveready to your receiving set, and enjoy the marked increase in effectiveness. Go to your radio equipment dealer—or write us.



No. 763 Eveready Airplane Wireless Battery.  
Standardized for use in U. S. Signal Corps Aviation Section

AMERICAN EVEREADY WORKS  
*of National Carbon Company, Inc.*  
227 Thompson Ave., Long Island City, New York  
Chicago                      Atlanta                      San Francisco

# EVEREADY

FLASHLIGHTS AND BATTERIES

A-25-TE

Every wireless operator has use for an Eveready Flashlight



# IF EDISON ASKED YOU

**(These) Electrical Questions — How Many Could You Answer?**

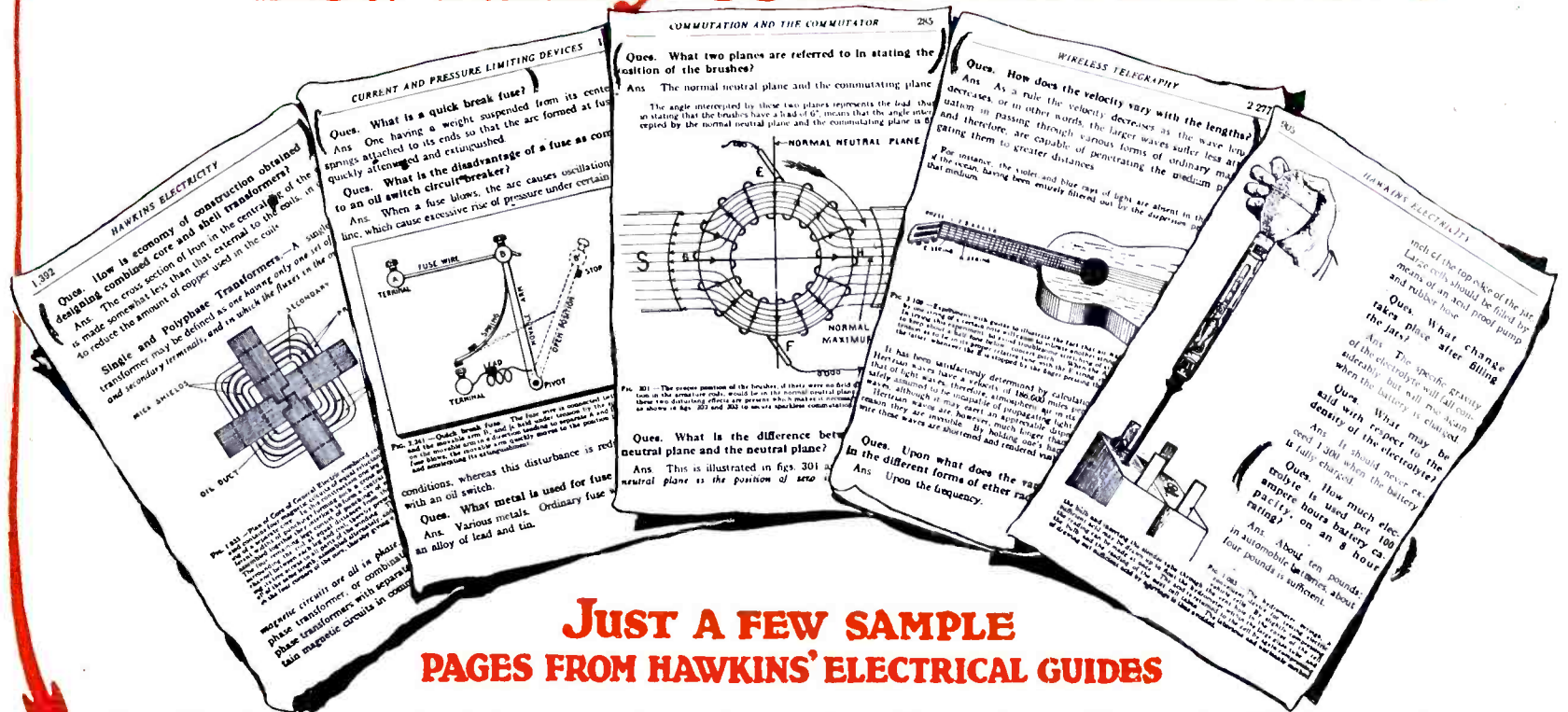

**JUST A FEW SAMPLE PAGES FROM HAWKINS' ELECTRICAL GUIDES**

- Ques.** What form of core requires the least amount of copper for the field magnetizing coils and why?  
(For answer see Guide No. 1, Page 207)
- Ques.** What error is introduced in measuring the pressure of a battery with an ordinary voltmeter?  
(For answer see Guide No. 2, Page 467)
- Ques.** What is a kick box?  
(For answer see Guide No. 3, Page 776)
- Ques.** What is a compositely excited alternator?  
(For answer see Guide No. 4, Page 1191)
- Ques.** What is the character of the constructions of three phase transformers?  
(For answer see Guide No. 5, Page 1439)

- Ques.** What are the essential parts of a Watt hour meter?  
(For answer see Guide No. 6, Page 1801)
- Ques.** What kind of current is used to ring party bells?  
(For answer see Guide No. 7, Page 2148)
- Ques.** (In radio telegraphy) How do the wave lengths of different forms of radiant energy emitted by ordinary matter vary?  
(For answer see Guide No. 8, Page 2274)
- Ques.** How is a wire supported in the single catenary construction?  
(For answer see Guide No. 9, Page 2624)
- Ques.** (In electro-plating work) What is stripping?  
(For answer see Guide No. 10, Page 3145)

## Hawkins' Electrical Guides

Flexible Covers—Handy Pocket Size Volumes. 10 Volumes—3500 Pages—4700 Pictures \$1 per Volume—\$1 per month

THESE guides are not only a complete Course in Electricity in Question and Answer Form, but an invaluable reference library that every electrical man should have. Ten volumes, Pocket size, flexible covers, handsomely bound, 3,500 Pages, 4,700 Illustrations.

These books will give you a complete electrical education. Hawkins' Electrical Guides will teach you electricity. With them the student is lead progressively and in such a way that he easily grasps not only the simple fundamentals, but also the more complex problems that will come up in his future work. Thousands of successful electrical men acquired their electrical education from these books.

If you are already a practical electrical man, the Hawkins' Guides are absolutely essential to your success.

**WE WILL SHIP THE COMPLETE LIBRARY FREE for YOUR INSPECTION**

It will cost you nothing to receive these books—to look them over—ask them all the questions you can think of—use them in your work—study them—pick up some information that will increase your earning ability. We will ship you the entire set of 10 volumes entirely FREE.

This is a sign of our confidence in the guides. Pure gold does not object to being tested. Keep them for seven days and if you do not decide that you can't get along without them, return them to us and owe us nothing.

When you decide to keep them you only have to pay \$1.00 down and remit the balance of \$9.00 on the easy payment of \$1.00 a month till paid for.

Use this coupon to get the books. It will pay you many times over.

**Theo. Audel & Co.**  
72 FIFTH AVENUE  
NEW YORK

Please submit me for examination Hawkins' Electrical Guides (price \$1 each). Ship at once, pre-paid, the 10 numbers. If satisfactory, I agree to send you \$1 within seven days and to further mail you \$1 each month until paid.

Signature.....  
Occupation.....  
Employed by.....  
Residence.....  
Reference.....

R. N. Oct. 21

**SEND NO MONEY—USE COUPON**



# It's Only a Step for You Now to a Fine Wireless Position

**S**URELY you have noticed how wireless is spreading over the world like wildfire! Every day you learn of some new field that is utilizing it—some new firm organized to push it forward. Big opportunities are open—and every day get more numerous and attractive. But do you realize that YOU can easily qualify for the wonderful opportunities that are opening? Amateurs—do you know that you can quickly build upon your present knowledge of Wireless—and be ready any time you wish for a fine Wireless position, either on land or on sea? You are in a fine position to cash in big on this growing field. Right at home you can easily build upon your present knowledge and quickly qualify. Through our special method of home-study instruction a short period of your spare time can be turned into preparation for a worthwhile future in the fastest-growing field in America today—Wireless. You have the whole foundation, all ready to build upon. Our new easy method of instruction makes the rest pure fun—but fun that-pays big.

The coupon below will bring you an interesting free booklet—telling about the splendid opportunities open, and how you can share them. Mail coupon for booklet today!



Both on sea and on land a fine future awaits the man who is qualified in wireless. No matter whether you wish to visit every nook and corner of the world or whether you prefer a land station, wireless awaits you.

## New Method Makes It Easy to Qualify

**W**ITHOUT obligation to yourself we would like to tell you more fully about the future wireless offers you. We would like to tell you about our Institute, which is officially recognized by the U. S. Dept. of Commerce and whose name heads the list of the schools recommended by the U. S. Shipping Board. The National Radio Institute was the original and is today the oldest and largest school in America teaching wireless by mail—having over 7000 students in all parts of the world. The government allows our graduates five to ten points credit when taking First Grade Government License examinations. We have graduates all over who have quickly qualified through our special new method.

This method not only includes a comprehensive course of instruction written exclusively for us by some of America's greatest wireless experts (members of our own staff) but also includes—as part of the course—a wonderful new

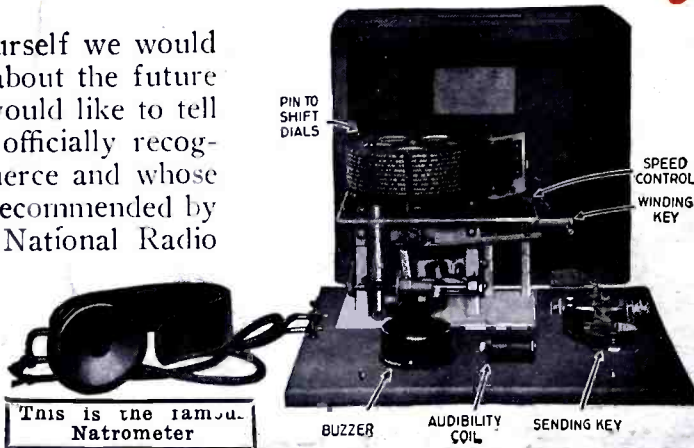

This is the famous Natrometer

invention patented and controlled only by us. This device, called the Natrometer, is pictured here. It teaches you in half the usual time how to send and receive, with speed and accuracy. This Natrometer (which can be purchased separately) is superior to any other device of its kind. Without aerials or any outside device it sends you any one of 600 different messages at a speed which you can vary from 3 to 100 words per minute. It is portable; also very attractive in appearance. It is noiseless; and it sends in a natural manner, not like a mechanical device. You get the messages thru its 'phones at whatever speed you wish. And this is *only one* of the features which our new method brings you. Others are listed below. Read them and you will realize why our students quickly qualify and why they step into the fine wireless positions that are waiting!

## 11 Points That Make This School the Best

1. Wonderful Natrometer Given with Course.
2. New Easy Method of Copyrighted Theory Instruction.



Besides being the largest school teaching Wireless by mail The National Radio Institute has large residence schools in Washington and Baltimore.

3. Our Diploma Given Government Credit and Recognition.
4. Our Location in Washington—Passing New Official Radio Developments on to You.
5. Personal, Individual Attention of Great Experts.
6. Guarantee of Position or Tuition Refunded.
7. Free Training in Wireless Telephony.
8. Unlimited Consultation and Advisory Service.
9. Free Post-Graduate Course, if You Wish, in Our Washington or Baltimore Residence School.
10. Membership in the National Radio Relay League.
11. Low Tuition Cost and Easy Terms of Payment.

Mail coupon today for our free illustrated booklet. "Wireless, the Opportunity of Today." Without cost or obligation, we want to tell you more about this field, its big opportunities both on land and on sea, and just how our new method quickly qualifies you. No agent will call upon you. We just want to send you the facts. Mail coupon at once!

**National Radio Institute**  
Dept. 110, Washington, D. C.

**NATIONAL RADIO INSTITUTE,**  
Dept. 110, Washington, D. C.

Send me your free booklet, "Wireless, the Opportunity of Today." Tell me about the opportunities open in wireless, about your Institute, and your offer.

Name ..... A. S. ....

(Please Write Plainly)

Address .....

City ..... State .....

I am interested in a Sea position.  I am interested in a Land position.

